

WINCHESTER®

REPEATING ARMS



MODEL
70

XPR



XPC

2018

2018

ANOTHER YEAR TO WIN WITH WINCHESTER.

The 2018 line from Winchester Repeating Arms® is an impressive mix of new models plus proven performers with long histories of providing outstanding accuracy and absolute reliability under the most demanding hunting and shooting conditions.

New for 2018 is the XPC™, a long range bolt-action equipped with a modular chassis stock that delivers exceptional long-range accuracy combined with incredible adaptability. The affordable XPR® bolt-action is now available with a stylish walnut stock. Also new are a trio of specialized hunting models of the slick-swinging, fast-cycling Super X®4 autoloading shotgun.

Historical buffs and Cowboy Action Shooters will flock to the new Model 1873 and Model 1892 Carabines. And the Rifleman's Rifle, the ever-classic Model 70® continues to set the standard of rifle performance. There's no better time than now to put a new Winchester in your gun rack.

CONTENTS

- XPR® 02-09
- MODEL 70® 10-19
- HISTORICAL 20-21
- MODEL 1866 22-23
- MODEL 1873 24-27
- MODEL 1885 28-29
- MODEL 1886 28-29
- MODEL 1892™ 30-31
- MODEL 94® 32-35
- SUPER X®4 36-43
- SUPER X®3 44-53
- SUPER X® PUMP 54-71
- MODEL 101™ 72-77
- ACCESSORIES 78-79
- EXTRA BARRELS 80-81
- EXPERTS 82-84





XPR.

XPRIENCE THE LAST WORD IN REAL-WORLD RIFLE PERFORMANCE.

The design leadership of Winchester Repeating Arms® enters a new era with the feature-packed XPR®. Accurate and rugged, the XPR utilizes advanced materials and the latest manufacturing technology to create a priced-right hunting rifle that gets the job done, every time. Take your pick of traditional models in wood, black composite or Mossy Oak® Break-Up Country® camo, or explore the potential of the new XPC™ with its advanced modular chassis stock.



HARDENED STEEL COMPONENTS

The trigger housing and all internal components in the XPR® rifle's M.O.A. trigger are constructed of polished and hardened carbon steel, many with a blued finish for added durability and corrosion resistance. The sear and actuator are **NICKEL TEFLON**® coated for reduced friction and added wear resistance.

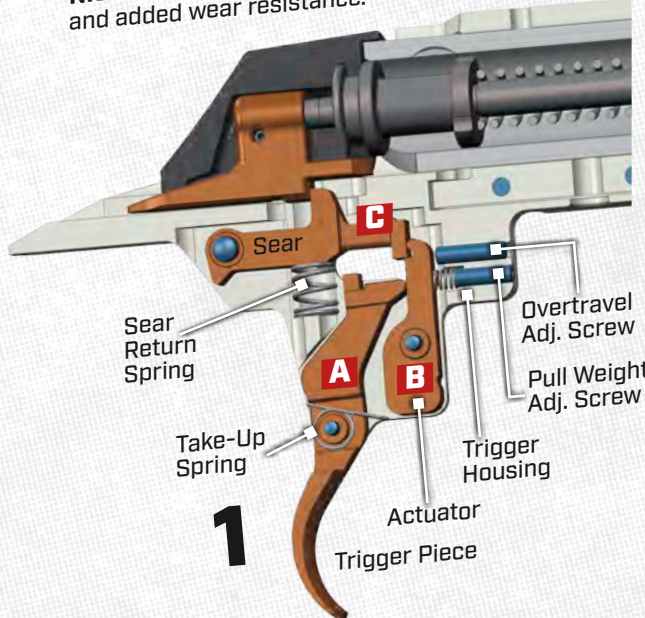

[1] M.O.A. TRIGGER SYSTEM

The XPR® rifle's M.O.A. Trigger System works on the simple principle of the pivoting lever. Pictured above are the trigger piece (A), actuator (B), and sear (C).

[2] 2:1 MECHANICAL ADVANTAGE

The M.O.A.'s trigger piece offers a wide, smooth face to better distribute finger pressure for a lighter, more sensitive feel. Because of its geometry and 2:1 mechanical advantage, the trigger piece travels only half the distance of the actuator (2X). Since this distance is cut in half, the perception of creep and overtravel are virtually eliminated. This means that your "feel" for the trigger is greatly enhanced, and thus your effective accuracy, both in the field and off the bench are improved.

ZERO TAKE-UP

Take-up is the distance the trigger piece travels prior to the sear moving toward release and the shooter feeling resistance. The XPR® moving system uses a spring to eliminate take-up by keeping M.O.A. Trigger System in constant contact with the actuator. Unlike many competitors' designs, the unique geometry of the M.O.A. pre-loads the entire trigger system to bias out normal manufacturing tolerances.

ZERO CREEP

Creep is the perceptible movement of the trigger prior to the release of the firing pin and has a negative influence on accuracy, causing inconsistency and uncertainty during the pull of the trigger. Creep contributes to jerking the trigger, thus adding to movement of the gun during firing. The 2:1 mechanical advantage created by this unique design geometry has virtually eliminated creep in the XPR® rifle's M.O.A. Trigger.

ZERO OVERTRAVEL

Overtravel is the rearward movement of the trigger after the firing pin has been released. It can actually jar the gun away from its intended point of aim and is very distracting to the shooter. The XPR® adjustable M.O.A. Trigger System is set at the factory for a crisp break at about 3 1/2 pounds with no perceptible overtravel. When the sear drops, the trigger stops. Where you aim is where you shoot.

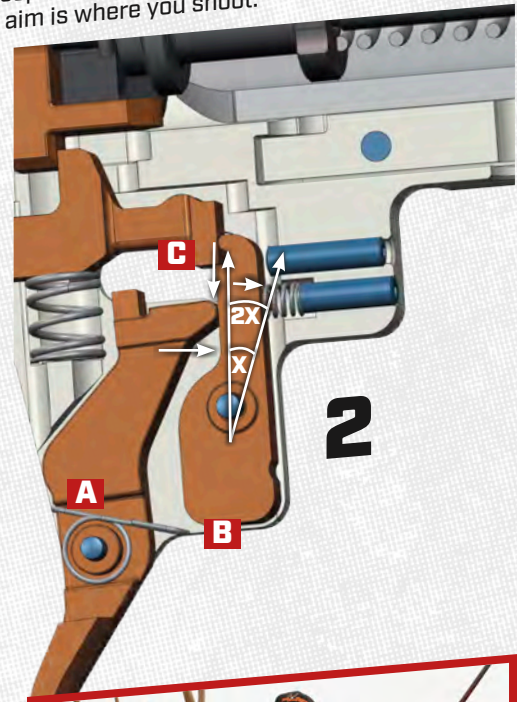

Every XPR® has a **TWO-POSITION SAFETY** that's convenient to operate with the thumb of your firing hand. The safety's design fully retracts the trigger away from the actuator. Located just in front of the safety button, the **BOLT RELEASE BUTTON** allows the action to cycle unfired cartridges while the safety is on. The **COCKING INDICATOR** on the bolt shroud gives you both a tactile and visual reference of the rifle's cocked/uncocked condition.



The robust **XPR® BOLT** is crafted from chromoly steel barstock and is through-hardened during heat-treatment. The bolt design offers three front locking lugs and a short 60-degree lift for improved scope clearance when cycling. The full-diameter bolt body creates a more rigid component. It is then coated with **NICKEL TEFLON**® for smoother operation and added corrosion resistance. The one-piece bolt handle is sculpted to give a more positive grip. The bolt can be fieldstripped in just seconds without special tools for cleaning and lubrication.



The one-piece **TRIGGER GUARD** and **MAGAZINE FRAME** design offers a generous guard opening for use with gloves. The **DETACHABLE BOX MAGAZINE** is constructed of a light yet rugged polymer and securely latches at both the front and rear. A single stack design feeds cartridges in a straight line to the chamber; the magazine's capacity is three rounds in both magnum and standard calibers. Additional magazines can be easily carried in a pocket or pack.

Every XPR® features a durable **PERMA-COTE™** matte black finish applied to the barrel, receiver and bolt handle to protect from wear and corrosion and to keep your rifle looking sharp for years to come.



The **CHROMOLY STEEL BARREL** on the XPR® rifle is precisely button-rifled to create outstanding accuracy with a wide variety of bullet weights and types. Every barrel is thermally stress relieved to ensure straight and true accuracy, even during long strings of fire. The **BARREL NUT** keeps the entire barrel/receiver assembly precisely aligned and allows for more accurate headspace control during manufacture. This means there is nothing to shift out of position and degrade accuracy. The entire barrel is **FREE-FLOATING** to eliminate any accuracy robbing pressure points.

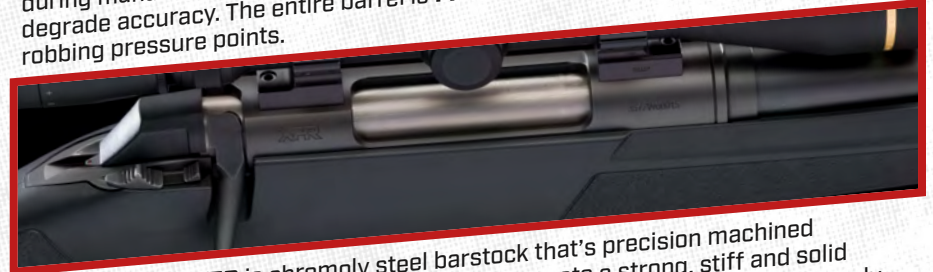

The **XPR® RECEIVER** is chromoly steel barstock that's precision machined and through-hardened during heat-treating to create a strong, stiff and solid receiver capable of delivering pinpoint accuracy. The ejection port is generously sized for more reliable ejection and easier access when loading single cartridges by hand. Two socket head action screws allow the receiver to be precisely torqued in the stock for maximum accuracy. The receiver is drilled and tapped for robust 8-40 screws, creating a more secure mounting for today's larger, high-magnification scopes.



The XPR® rifle's **ADVANCED POLYMER STOCK** comes in a choice of subdued finishes with textured panels on the fore-end and pistol grip to improve grip in cold, wet weather. The fore-end has rounded edges plus a slightly flattened bottom profile for comfortable shooting from any position. This flattened profile also optimizes stability when firing off sandbags or a rest.



A critical feature of any high-powered rifle is how the action and barrel are set in the stock. The XPR rifle's receiver nestles onto **FLAT PROFILE INTERFACE PADS** and into a cross-mounted recoil lug to resist flex and twist when firing. The XPR will hold its zero under the most adverse conditions.

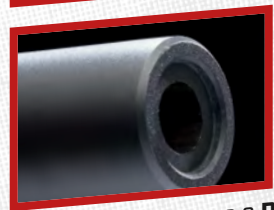

Every XPR® features a **RECESSED TARGET-STYLE CROWN** at the muzzle to protect the rifling from nicks and dings. Each bullet exits the barrel uniformly for the ultimate in downrange accuracy.



The **INFLEX TECHNOLOGY RECOIL PAD** has specially-shaped internal rib structures that redirect the recoil impulse, moving the comb down and away from your face. The ideally contoured contact area on the XPR® rifle offers optimal protection against "felt recoil," even when shooting today's magnum loads.

Selected models of the XPR® are also available in a **COMPACT VERSION, WITH A SHORTER 13" LENGTH OF PULL**, making it a perfect fit for younger shooters and those of smaller stature.

"I HUNT IN TOUGH CONDITIONS SO I NEED A RIFLE THAT WILL HOLD UP IN BRUTAL WEATHER, RUGGED TERRAIN AND ALWAYS PERFORM. ACCURACY AND RELIABILITY ARE ABSOLUTELY NECESSARY, AND MY FIRST CHOICE IS THE WINCHESTER XPR.™"
— Melissa Bachman • Winchester Deadly Passion



REACH OUT.

BASED ON THE ACCURATE XPR PLATFORM, IT'S A PRECISION RIFLE THAT'S READY TO TAKE ON ANY TARGET AT ANY RANGE.

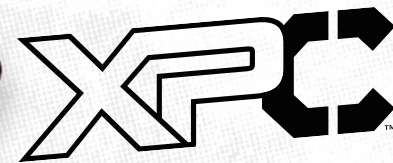

- **ADVANCED FULLY MACHINED ALLOY CHASSIS FRAME WITH BLACK CERAKOTE FINISH** provides maximum accuracy and full adaptability for both the shooter and the situation
- **FULL-LENGTH PICATINNY RAIL** for mounting optics, lights and other accessories
- **M-LOK® SLOT SYSTEM ON FOREARM AND BUTTSTOCK** for mounting accessories
- **MAGPUL® PRS® GEN 3 FULLY ADJUSTABLE BUTTSTOCK** has multiple QD sling sockets and is fitted on a standard A2-style buffer tube
- **MAGPUL MOE-K® PISTOL GRIP** for perfect hand placement
- **M.O.A. TRIGGER SYSTEM** with zero take-up, zero creep and zero overtravel gives you outstanding accuracy
- **TWO-PIECE EXTENDED BOLT HANDLE** for sure, fast cycling from any shooting position
- **BOLT UNLOCK BUTTON** allows the chamber to be unloaded with the thumb safety in the on safe position
- **NICKEL TEFLON®** on the bolt body offers smoother operation and added corrosion resistance

- **PERMA-COTE™ MATTE BLACK FINISH** on barrel and receiver minimize glare to help prevent game-spooking reflections and protect from corrosion
- **RECEIVER IS MACHINED FROM SOLID STEEL BAR STOCK** and through-hardened during heat treating for longer life and enhanced accuracy, and comes fitted with a top-mounted 20 MOA Picatinny scope rail
- **TWO-POSITION THUMB SAFETY** and a cocking indicator show the XPR® rifle's safety status at a glance or by feel
- **HEAVY PROFILE BUTTON-RIFLED, FREE-FLOATED STEEL BARREL** is thermally stress-relieved then precisely aligned and headspaced during assembly via the barrel nut
- **RECESSED TARGET CROWN** protects the muzzle rifling from wear and impact damage to help maintain greater accuracy
- **THREADED MUZZLE (5/8" X 24TPI)** for adding an optional sound suppressor or muzzle brake, and a thread protector collar is included
- **ONE 10-ROUND MAGPUL® POLYMER DETACHABLE BOX MAGAZINE IS INCLUDED**



MAGPUL® PRS® GEN 3 BUTTSTOCK is fully adjustable. 1 3/8" in length of pull and 3/4" in cheek piece height.

MAGPUL® MOE-K® PISTOL GRIP AND PMAG® 10-ROUND MAGAZINE are standard on the XPC™. It also accepts AICS-compatible magazines.

FULLY-MACHINED ALLOY VENTED FOREARM has a full-length Picatinny top rail and multiple M-LOK® mounting points for accessories.



PICATINNY TOP RAIL WITH 20 MOA ADDITIONAL ELEVATION enhances the long range potential of the XPC™.

TWO-PIECE EXTENDED BOLT HANDLE gives greater leverage for easier cycling.

5/8" X 24 TPI THREADED MUZZLE accepts optional accessories like sound suppressors and muzzle brakes.

	ITEM NUMBER	CALIBER	MAGAZINE CAPACITY	BARREL LENGTH	OVERALL LENGTH	LENGTH OF PULL*	DROP AT COMB**	DROP AT HEEL	NOMINAL WT. (LBS)	RATE OF TWIST	SUGGESTED RETAIL
XPC		243 Win	10	24"	44 1/4"	13 3/4"	1/2"	5/8"	10	10"	\$1,599.99
NEW	535724212	243 Win	10	24"	44 1/4"	13 3/4"	1/2"	5/8"	10	8"	1,599.99
NEW	535724289	6.5 Creedmoor	10	20"	40 1/4"	13 3/4"	1/2"	5/8"	9 1/4	10"	1,599.99
NEW	535723290	308 Win	10	20"	40 1/4"	13 3/4"	1/2"	5/8"	9 1/4	10"	1,599.99

*LENGTH OF PULL MEASURED IN SHORTEST SETTING. **DROP AT COMB MEASURED IN LOWEST SETTING.



CAMO UP.

DISAPPEAR INTO THE BACKWOODS BACKGROUND WITH A CAMO XPR.



HUNTER COMPACT



HUNTER



- **M.O.A. TRIGGER SYSTEM** with zero take-up, zero creep and zero overtravel gives you outstanding accuracy
- **BOLT UNLOCK BUTTON** allows the chamber to be unloaded with the thumb safety in the on safe position
- **NICKEL TEFLON** on the bolt body offers smoother operation and added corrosion resistance
- **DETACHABLE BOX MAGAZINE** is a single stack design constructed from a rugged polymer for greater reliability
- **ADVANCED POLYMER STOCK IN MOSSY OAK** Break-Up Country[™] camo. Textured panels help improve wet weather grip, while the flattened fore-end profile improves stability from sandbags or a benchrest.
- **SHORTER 13" LENGTH OF PULL OF THE COMPACT MODEL** makes it perfect for younger shooters and those of smaller stature
- **PERMA-COTE[™] MATTE FINISH ON THE BARREL, RECEIVER AND BOLT HANDLE** helps minimize glare to help prevent game-spooking reflections and protect these parts from corrosion. Full-size guns are matte black and compact models are dark gray.

- **INFLEX TECHNOLOGY RECOIL PAD** directs energy down and away from your cheek to reduce felt recoil. The XPR[™] Hunter Compact is fitted with a plush Pachmayr[™] Decelerator[™] recoil pad.
- **STEEL RECOIL LUG** is inletted into the stock to prevent the receiver from twisting under recoil for more reliable and predictable long-range accuracy
- **RECEIVER IS MACHINED FROM SOLID STEEL BAR STOCK** and through-hardened during heat treating for longer life and enhanced accuracy
- **TWO-POSITION THUMB SAFETY** and a cocking indicator show the XPR[™] rifle's safety status at a glance or by feel
- **BUTTON-RIFLED, FREE-FLOATED STEEL BARREL** is thermally stress-relieved then precisely aligned and headspaced during assembly via the barrel nut
- **RECESSED TARGET CROWN** protects the muzzle rifling from wear and impact damage to help maintain greater accuracy



WINCHESTER[™] DEER SEASON XP. BIGGER TIP, BIGGER IMPACT. Deer Season XP[™] is the first ammunition ever designed specifically by Winchester[™] for hunting deer. The Extreme Point[™] bullets feature a radically new, large-tip-diameter technology to deliver massive energy immediately on impact to put deer down quickly.

	ITEM NUMBER	CALIBER	MAGAZINE CAPACITY	BARREL LENGTH	OVERALL LENGTH	LENGTH OF PULL	DROP AT COMB	DROP AT HEEL	NOMINAL WT. (LBS)	RATE OF TWIST	SUGGESTED RETAIL
XPR HUNTER COMPACT BREAK-UP COUNTRY											
	535721212	243 Win	3	20"	39 1/4"	13"	1/2"	3/4"	6 1/2	10"	\$599.99
NEW	535721289	6.5 Creedmoor	3	20"	39 1/4"	13"	1/2"	3/4"	6 1/2	8"	599.99
	535721218	7mm-08 Rem	3	20"	39 1/4"	13"	1/2"	3/4"	6 1/2	9 1/2"	599.99
	535721220	308 Win	3	20"	39 1/4"	13"	1/2"	3/4"	6 1/2	12"	599.99
	535721264	270 WSM	3	22"	41 1/4"	13"	1/2"	3/4"	6 3/4	10"	599.99
	535721255	300 WSM	3	22"	41 1/4"	13"	1/2"	3/4"	6 3/4	10"	599.99
	535721277	325 WSM	3	22"	41 1/4"	13"	1/2"	3/4"	6 3/4	10"	599.99
XPR HUNTER BREAK-UP COUNTRY											
	535704212	243 Win	3	22"	42"	13 3/4"	1/2"	3/4"	6 3/4	10"	\$599.99
NEW	535704289	6.5 Creedmoor	3	22"	42"	13 3/4"	1/2"	3/4"	6 3/4	8"	599.99
	535704218	7mm-08 Rem	3	22"	42"	13 3/4"	1/2"	3/4"	6 3/4	9 1/2"	599.99
	535704220	308 Win	3	22"	42"	13 3/4"	1/2"	3/4"	6 3/4	12"	599.99
	535704264	270 WSM	3	24"	44"	13 3/4"	1/2"	3/4"	7	10"	599.99
	535704255	300 WSM	3	24"	44"	13 3/4"	1/2"	3/4"	7	10"	599.99
	535704277	325 WSM	3	24"	44"	13 3/4"	1/2"	3/4"	7	10"	599.99
	535704226	270 Win	3	24"	44 1/2"	13 3/4"	1/2"	3/4"	7	10"	599.99
	535704228	30-06 Sprg	3	24"	44 1/2"	13 3/4"	1/2"	3/4"	7 1/4	9 1/2"	599.99
	535704230	7mm Rem Mag	3	26"	46 1/2"	13 3/4"	1/2"	3/4"	7 1/4	10"	599.99
	535704233	300 Win Mag	3	26"	46 1/2"	13 3/4"	1/2"	3/4"	7 1/4	10"	599.99
	535704236	338 Win Mag	3	26"	46 1/2"	13 3/4"	1/2"	3/4"	7 1/4	10"	599.99



NEW STANDARD.

THE BOLT-ACTION THAT SETS A NEW STANDARD IN RIFLE PERFORMANCE.



NEW SPORTER



- **M.O.A. TRIGGER SYSTEM** with zero take-up, zero creep and zero overtravel gives you outstanding accuracy
- **BOLT UNLOCK BUTTON** allows the chamber to be unloaded with the thumb safety in the on safe position
- **NICKEL TEFLON** on the bolt body offers smoother operation and added corrosion resistance
- **DETACHABLE BOX MAGAZINE** is a single stack design constructed from a rugged polymer for greater reliability
- **CLOSE-GRAINED GRADE I WALNUT STOCK** with crisp checkering on the pistol grip and fore-end. The flattened fore-end profile improves stability from sandbags or a benchrest
- **PERMA-COTE™ MATTE BLACK METAL SURFACES** minimize glare to help prevent game-spooking reflections and protect from corrosion

- **INFLEX TECHNOLOGY RECOIL PAD** directs energy down and away from your cheek to reduce felt recoil
- **STEEL RECOIL LUG** is inletted into the stock to prevent the receiver from twisting under recoil for more reliable and predictable long-range accuracy
- **RECEIVER IS MACHINED FROM SOLID STEEL BAR STOCK** and through-hardened during heat treating for longer life and enhanced accuracy
- **TWO-POSITION THUMB SAFETY** and a cocking indicator show the XPR® rifle's safety status at a glance or by feel
- **BUTTON-RIFLED, FREE-FLOATED STEEL BARREL** is thermally stress-relieved then precisely aligned and headspaced during assembly via the barrel nut
- **RECESSED TARGET CROWN** protects the muzzle rifling from wear and impact damage to help maintain greater accuracy

	ITEM NUMBER	CALIBER	MAGAZINE CAPACITY	BARREL LENGTH	OVERALL LENGTH	LENGTH OF PULL	DROP AT COMB	DROP AT HEEL	NOMINAL WT. (LBS)	RATE OF TWIST	SUGGESTED RETAIL
XPR SPORTER											
NEW	535709212	243 Win	3	22"	42"	13 3/4"	1/2"	3/4"	6 3/4"	10"	\$599.99
NEW	535709289	6.5 Creedmoor	3	22"	42"	13 3/4"	1/2"	3/4"	6 3/4"	8"	599.99
NEW	535709218	7mm-08 Rem	3	22"	42"	13 3/4"	1/2"	3/4"	6 3/4"	9 1/2"	599.99
NEW	535709220	308 Win	3	24"	44"	13 3/4"	1/2"	3/4"	7"	10"	599.99
NEW	535709264	270 WSM	3	24"	44"	13 3/4"	1/2"	3/4"	7"	10"	599.99
NEW	535709255	300 WSM	3	24"	44"	13 3/4"	1/2"	3/4"	7"	10"	599.99
NEW	535709277	325 WSM	3	24"	44 1/2"	13 3/4"	1/2"	3/4"	7"	10"	599.99
NEW	535709226	270 Win	3	24"	44 1/2"	13 3/4"	1/2"	3/4"	7 1/4"	9 1/2"	599.99
NEW	535709228	30-06 Sprg	3	26"	46 1/2"	13 3/4"	1/2"	3/4"	7 1/4"	10"	599.99
NEW	535709230	7mm Rem Mag	3	26"	46 1/2"	13 3/4"	1/2"	3/4"	7 1/4"	10"	599.99
NEW	535709233	300 Win Mag	3	26"	46 1/2"	13 3/4"	1/2"	3/4"	7 1/4"	10"	599.99
NEW	535709236	338 Win Mag	3	26"	46 1/2"	13 3/4"	1/2"	3/4"	7 1/4"	10"	599.99
XPR											
	535700212	243 Win	3	22"	42"	13 3/4"	1/2"	3/4"	6 3/4"	10"	\$549.99
NEW	535700289	6.5 Creedmoor	3	22"	42"	13 3/4"	1/2"	3/4"	6 3/4"	8"	549.99
	535700218	7mm-08 Rem	3	22"	42"	13 3/4"	1/2"	3/4"	6 3/4"	9 1/2"	549.99
	535700220	308 Win	3	24"	44"	13 3/4"	1/2"	3/4"	7"	10"	549.99
	535700264	270 WSM	3	24"	44"	13 3/4"	1/2"	3/4"	7"	10"	549.99
	535700255	300 WSM	3	24"	44"	13 3/4"	1/2"	3/4"	7"	10"	549.99
	535700277	325 WSM	3	24"	44 1/2"	13 3/4"	1/2"	3/4"	7"	10"	549.99
	535700226	270 Win	3	24"	44 1/2"	13 3/4"	1/2"	3/4"	7 1/4"	9 1/2"	549.99
	535700228	30-06 Sprg	3	26"	46 1/2"	13 3/4"	1/2"	3/4"	7 1/4"	10"	549.99
	535700230	7mm Rem Mag	3	26"	46 1/2"	13 3/4"	1/2"	3/4"	7 1/4"	10"	549.99
	535700233	300 Win Mag	3	26"	46 1/2"	13 3/4"	1/2"	3/4"	7 1/4"	10"	549.99
	535700236	338 Win Mag	3	26"	46 1/2"	13 3/4"	1/2"	3/4"	7 1/4"	10"	549.99
XPR COMPACT											
	535720212	243 Win	3	20"	39 1/4"	13"	1/2"	3/4"	6 1/2"	10"	\$549.99
NEW	535720289	6.5 Creedmoor	3	20"	39 1/4"	13"	1/2"	3/4"	6 1/2"	8"	549.99
	535720218	7mm-08 Rem	3	20"	39 1/4"	13"	1/2"	3/4"	6 1/2"	9 1/2"	549.99
	535720220	308 Win	3	22"	41 1/4"	13"	1/2"	3/4"	6 3/4"	10"	549.99
	535720264	270 WSM	3	22"	41 1/4"	13"	1/2"	3/4"	6 3/4"	10"	549.99
	535720255	300 WSM	3	22"	41 1/4"	13"	1/2"	3/4"	6 3/4"	10"	549.99
	535720277	325 WSM	3	22"	41 1/4"	13"	1/2"	3/4"	6 3/4"	10"	549.99

(SCOPE AND MOUNTS SHOWN NOT INCLUDED)



XPR® & COMPACT



- **M.O.A. TRIGGER SYSTEM** with zero take-up, zero creep and zero overtravel gives you outstanding accuracy
- **BOLT UNLOCK BUTTON** allows the chamber to be unloaded with the thumb safety in the on safe position
- **NICKEL TEFLON** on the bolt body offers smoother operation and added corrosion resistance
- **DETACHABLE BOX MAGAZINE** is a single stack design constructed from a rugged polymer for greater reliability
- **ADVANCED POLYMER STOCK** with textured panels help improve wet weather grip, while the flattened fore-end profile improves stability from sandbags or a benchrest
- **SHORTER 13" LENGTH OF PULL ON COMPACT** makes it perfect for younger shooters and those of smaller stature
- **PERMA-COTE™ MATTE FINISH ON THE BARREL, RECEIVER AND BOLT HANDLE** helps minimize glare to help prevent game-spooking reflections and protect these parts from corrosion. Full-size guns are matte black and compact models are dark gray.

- **INFLEX TECHNOLOGY RECOIL PAD** directs energy down and away from your cheek to reduce felt recoil. The XPR® Compact is fitted with a plush Pachmayr® Decelerator® recoil pad.
- **STEEL RECOIL LUG** is inletted into the stock to prevent the receiver from twisting under recoil for more reliable and predictable long-range accuracy
- **RECEIVER IS MACHINED FROM SOLID STEEL BAR STOCK** and through-hardened during heat treating for longer life and enhanced accuracy
- **TWO-POSITION THUMB SAFETY** and a cocking indicator show the XPR® rifle's safety status at a glance or by feel
- **BUTTON-RIFLED, FREE-FLOATED STEEL BARREL** is thermally stress-relieved then precisely aligned and headspaced during assembly via the barrel nut
- **RECESSED TARGET CROWN** protects the muzzle rifling from wear and impact damage to help maintain greater accuracy

MODEL 70[®]

NOW AND FOREVER, THE RIFLEMAN'S RIFLE.
 No other bolt-action in history can inspire the passion, command the loyalty or create a sense of excitement among dedicated marksmen like the Model 70[®]. Since 1936, it's been the benchmark against which every other bolt-action rifle is measured. Visit your Winchester Repeating Arms[®] dealer and discover The Rifleman's Rifle for yourself.



STAINLESS STEEL COMPONENTS

The trigger housing and all internal components of the M.O.A. Trigger System are constructed of durable, corrosion-resistant stainless steel.

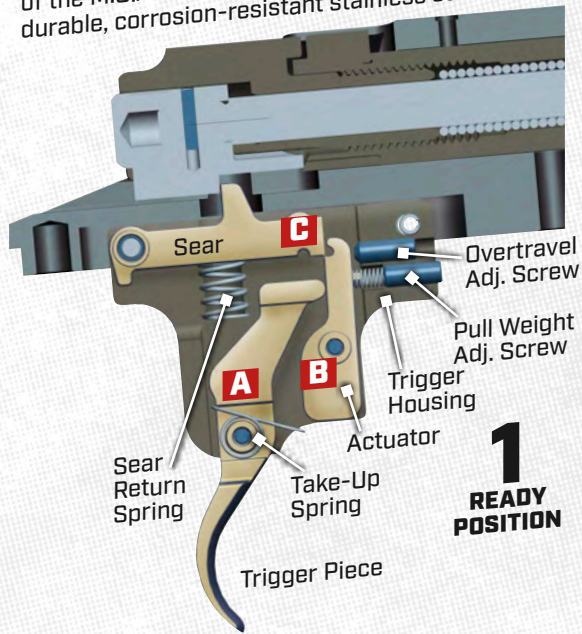

(1) M.O.A. TRIGGER SYSTEM

The Model 70[®] rifle's M.O.A. Trigger System works on the simple principle of the pivoting lever. Pictured above are the trigger piece (A), actuator (B), and sear (C). The housing and all internal parts, pins and springs are precision crafted from stainless steel. In addition, the sear and actuator are Slick Shot[™] electroless nickel Teflon[™] coated for corrosion resistance and smoother operation.

(2) 2:1 MECHANICAL ADVANTAGE

The M.O.A.'s trigger piece offers a wide, smooth face to better distribute finger pressure for a lighter, more sensitive feel. Because of its geometry and 2:1 mechanical advantage, the trigger piece travels only half the distance of the actuator (2X). Since this distance is cut in half, the perception of creep and overtravel are virtually eliminated.

ZERO TAKE-UP

Take-up is the distance the trigger piece travels prior to the sear moving toward release and the shooter feeling resistance. The M.O.A. Trigger System uses a spring to eliminate take-up by keeping the trigger piece in constant contact with the actuator. Unlike competitors' designs, the unique geometry of the M.O.A. pre-loads the entire trigger system to bias out normal manufacturing tolerances.

ZERO CREEP

Creep is the perceptible movement of the trigger prior to the release of the firing pin and has a negative influence on accuracy causing inconsistency and uncertainty during the pull of the trigger. Creep contributes to jerking the trigger, thus adding to movement of the gun during firing. The 2:1 mechanical advantage created by the M.O.A. Trigger's unique design geometry has virtually eliminated creep in the Model 70[®] M.O.A. Trigger.

ZERO OVERTRAVEL

Overtravel is the rearward movement of the trigger after the firing pin has been released. It can actually jar the gun away from its intended point of aim and is very distracting to the shooter. The Model 70[®] M.O.A. Trigger System is set at the factory to have no perceptible overtravel. When the sear drops, the trigger stops. Where you aim is where you shoot.

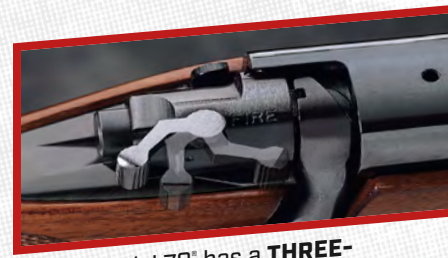
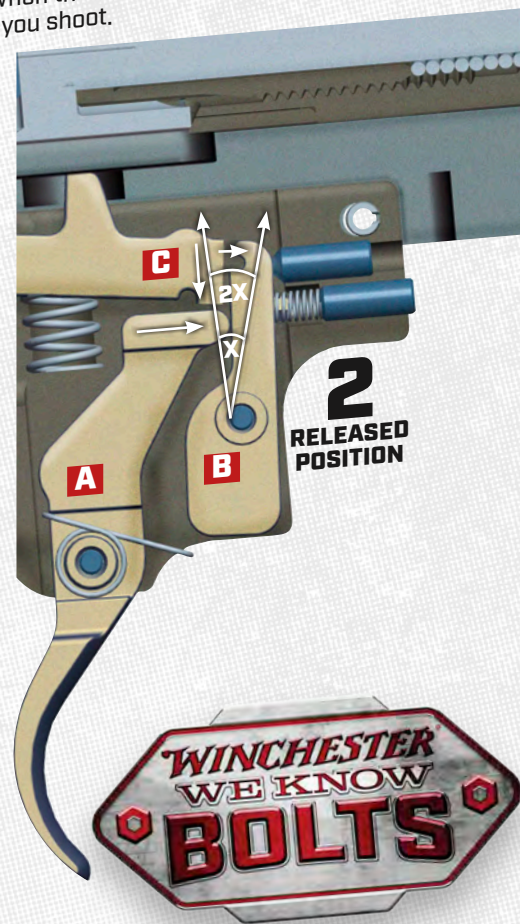

Every Model 70[®] has a **THREE-POSITION SAFETY** that is convenient to operate with the thumb of your firing hand. The design retracts the firing pin away from the sear. When the safety selector is in the middle position, the action can still be operated, allowing unfired cartridges to be cycled with the safety on. It's smooth to engage and easily identifies, by sight and feel, the safety status of the rifle.



A **BLADE-TYPE EJECTOR** gives you full control when ejecting a fired case. Pull the bolt back slowly and the empty case pops out gently — perfect for target shooters and varminters. Pull the bolt back sharply and the empty case clears the port with greater force.



If there were a single feature responsible for the Model 70[®] rifle being labeled the "Bolt-Action Rifle of the Century," it would be the classic Pre-'64 style **CONTROLLED ROUND FEED AND CLAW EXTRACTOR (CRF)** bolt design. The massive claw extractor secures the cartridge's base, exerting full control from the very moment it leaves the magazine and enters the chamber, gripping it tightly until it's fully ejected. This time-proven design allows an unfired cartridge to be extracted even if it is not yet fully chambered.

THE STEEL RECEIVER IS FORGED for superior material properties. Each forging is precision machined to create a strong, stiff and solid receiver that resists flexing and delivers top accuracy over a lifetime of shooting. The bottom profile of the Model 70[®] receiver is flat to offer more surface area for bedding. It's then bedded at the front and rear to eliminate shifts in zero and preserve pinpoint accuracy. The flat bottom contour also resists twisting inside the stock during firing, making it superior to the competitors' round bottom receivers.



THE INTEGRAL RECOIL LUG on the Model 70[®] is actually forged and machined as part of the receiver. It's a hefty block of solid steel, not a mere washer or tab that's just sandwiched between the barrel and the action during assembly. This allows the barrel to be trued in perfect alignment to the front ring of the receiver for greater accuracy. There is nothing to move, settle or shift the barrel out of alignment, ever. It's what makes a Model 70 rifle shoot straight and true, year after year.

The trigger guard and magazine frame of each Model 70[®] rifle feature a solid, **ONE-PIECE BOTTOM METAL** supporting the action through the magazine well. This added rigidity contributes to accuracy and integrity better than two-piece systems. The hinged magazine floorplate speeds unloading of the cartridges to avoid having to cycle them through the action. The action and trigger guard are held in place by stout hex head screws.



You can expect **1 MOA ACCURACY** for three-shot groups from your Model 70[®] rifle using high-quality ammo and optics under suitable weather and range conditions.

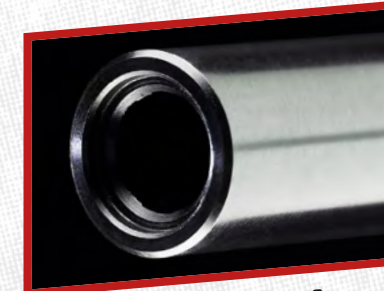

Every Model 70[®] features a **RECESSED TARGET CROWN** at the muzzle to protect the rifling from nicks and dings. Each bullet exits the barrel uniformly, with ultimate precision.



Critical to rifle accuracy is how the barrel is made and set in the stock. Model 70[®] barrels have a reputation for delivering top accuracy, even during the heat of long strings of fire. Every precision rifled Model 70 barrel is **FREE-FLOATING** in the stock so that no part of the fore-end touches the barrel, because pressure from contacting the stock adversely influences accuracy.



The **RECOIL PAD** on Model 70[®] rifles is a premium Pachmayr[®] Decelerator[®] recoil pad. This industry leading pad offers optimal protection against felt recoil.

ICONIC.

THE MODEL 70® IS EVERYTHING YOU THINK A RIFLE SHOULD BE.



SUPER GRADE



- **GRADE IV/V FULL FANCY WALNUT STOCK WITH SHADOWLINE CHEEKPIECE** places your eye in perfect alignment with the scope
- **HIGHLY POLISHED METAL SURFACES** add style and elegance
- **STEEL ONE-PIECE BOTTOM METAL** with steel floorplate adds rigidity for better accuracy
- **ENGRAVED STEEL CROSSBOLT** adds strength, rigidity and a touch of stylish refinement
- **INLETTED SLING SWIVEL STUDS** allow you to attach your favorite sling
- **FORGED STEEL RECEIVER WITH INTEGRAL RECOIL LUG** is bedded front and rear to eliminate shifts in zero for exceptional long-range accuracy
- **PRE-'64 STYLE CONTROLLED ROUND FEED WITH CLAW EXTRACTOR** fully controls the cartridge from magazine, to chamber, to ejection

- **THREE-POSITION SAFETY** allows you to unload the chamber while on safe and shows safety status at a glance
- **FREE-FLOATING BARREL** for years of pinpoint accuracy
- **RECESSED TARGET CROWN** enhances accuracy and protects the rifling
- **M.O.A. TRIGGER SYSTEM** with zero take-up, zero creep and zero overtravel gives you outstanding accuracy
- **BLADE-TYPE EJECTOR** for full control of ejection force
- **PACHMAYR® DECELERATOR® RECOIL PAD** for optimal protection against felt recoil

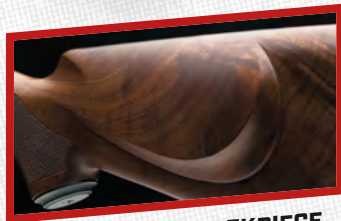

SHADOWLINE CHEEKPIECE

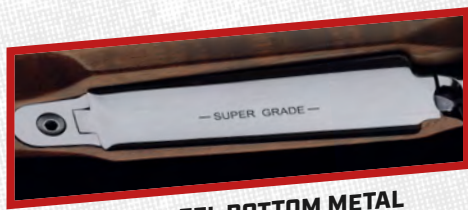

ONE-PIECE STEEL BOTTOM METAL



RAISED CHEEKPIECE



SPORTER



- **SATIN FINISH GRADE I WALNUT STOCK WITH CUT CHECKERING AND DELUXE CHEEKPIECE** places your eye in perfect alignment with the scope
- **POLISHED METAL SURFACES** add style and elegance
- **STEEL SLING SWIVEL STUDS** allow you to attach your favorite sling
- **ALLOY ONE-PIECE BOTTOM METAL** adds rigidity for better accuracy
- **FORGED STEEL RECEIVER WITH INTEGRAL RECOIL LUG** is bedded front and rear to eliminate shifts in zero for exceptional long-range accuracy
- **PRE-'64 STYLE CONTROLLED ROUND FEED WITH CLAW EXTRACTOR** fully controls the cartridge from magazine, to chamber, to ejection

- **THREE-POSITION SAFETY** allows you to unload the chamber while on safe and shows safety status at a glance
- **FREE-FLOATING BARREL** for years of pinpoint accuracy
- **RECESSED TARGET CROWN** enhances accuracy and protects the rifling
- **M.O.A. TRIGGER SYSTEM** with zero take-up, zero creep and zero overtravel gives you outstanding accuracy
- **BLADE-TYPE EJECTOR** for full control of ejection force
- **PACHMAYR® DECELERATOR® RECOIL PAD** for optimal protection against felt recoil

ITEM NUMBER	CALIBER	MAGAZINE CAPACITY	BARREL LENGTH	OVERALL LENGTH	LENGTH OF PULL	DROP AT COMB	DROP AT HEEL	NOMINAL WT. (LBS)	RATE OF TWIST	SUGGESTED RETAIL
MODEL 70 SUPER GRADE										
535203264	270 WSM	3	24"	44 1/4"	13 3/4"	1/2"	1/2"	8	10"	\$1,479.99
535203255	300 WSM	3	24"	44 1/4"	13 3/4"	1/2"	1/2"	8	10"	1,479.99
535203226	270 Win	5	24"	44 3/4"	13 3/4"	1/2"	1/2"	8 1/4	10"	1,439.99
535203228	30-06 Sprg	5	24"	44 3/4"	13 3/4"	1/2"	1/2"	8 1/4	10"	1,479.99
535203230	7mm Rem Mag	3	26"	46 3/4"	13 3/4"	1/2"	1/2"	8 1/2	9 1/2"	1,479.99
535203233	300 Win Mag	3	26"	46 3/4"	13 3/4"	1/2"	1/2"	8 1/2	10"	1,479.99
535203236	338 Win Mag	3	26"	46 3/4"	13 3/4"	1/2"	1/2"	8 1/2	10"	1,479.99
MODEL 70 SPORTER										
535202264	270 WSM	3	24"	44 1/4"	13 3/4"	1/2"	1/2"	7 1/4	10"	\$1,049.99
535202255	300 WSM	3	24"	44 1/4"	13 3/4"	1/2"	1/2"	7 1/4	10"	1,049.99
535202277	325 WSM	3	24"	44 1/4"	13 3/4"	1/2"	1/2"	7 1/4	10"	1,009.99
535202225	25-06 Rem	5	24"	44 3/4"	13 3/4"	1/2"	1/2"	7 1/4	10"	1,009.99
535202226	270 Win	5	24"	44 3/4"	13 3/4"	1/2"	1/2"	7 1/4	9"	1,049.99
535202228	30-06 Sprg	5	24"	44 3/4"	13 3/4"	1/2"	1/2"	7 3/4	9 1/2"	1,049.99
535202229	264 Win Mag	3	26"	46 3/4"	13 3/4"	1/2"	1/2"	7 3/4	10"	1,049.99
535202230	7mm Rem Mag	3	26"	46 3/4"	13 3/4"	1/2"	1/2"	7 3/4	10"	1,049.99
535202233	300 Win Mag	3	26"	46 3/4"	13 3/4"	1/2"	1/2"	7 3/4	10"	1,049.99
535202236	338 Win Mag	3	26"	46 3/4"	13 3/4"	1/2"	1/2"	7 3/4	10"	1,049.99

(SCOPE AND MOUNTS SHOWN NOT INCLUDED)

TRUSTED.

THE RIFLES YOU CAN TRUST FOR THAT ONCE-IN-A-LIFETIME OUTDOOR ADVENTURE.



DOUBLE RECOIL LUGS



SAFARI EXPRESS DELUXE CHEEKPIECE



DOUBLE CROSS BOLTS

SAFARI EXPRESS



- SATIN FINISH GRADE I WALNUT STOCK WITH CUT CHECKERING AND DELUXE CHEEKPIECE places your eye in perfect alignment with open sights or a scope
- STEEL ONE-PIECE BOTTOM METAL WITH STEEL FLOORPLATE adds rigidity for better accuracy
- MATTE FINISHED METAL SURFACES reduce glare
- DUAL STEEL CROSSBOLTS add strength, rigidity and a touch of stylish refinement
- FORGED STEEL RECEIVER WITH DUAL RECOIL LUGS is bedded front and rear to eliminate shifts in zero for exceptional long-range accuracy
- PRE-'64 STYLE CONTROLLED ROUND FEED WITH CLAW EXTRACTOR fully controls the cartridge from magazine, to chamber, to ejection

- THREE-POSITION SAFETY allows you to unload the chamber while on safe and shows safety status at a glance
- FREE-FLOATING BARREL for years of pinpoint accuracy
- FULLY ADJUSTABLE REAR SIGHT AND HOODED BRASS BEAD FRONT get you on target quickly
- BARREL-MOUNTED FRONT SLING SWIVEL adds a classic touch
- RECESSED TARGET CROWN enhances accuracy and protects the rifling
- M.O.A. TRIGGER SYSTEM with zero take-up, zero creep and zero overtravel gives you outstanding accuracy
- BLADE-TYPE EJECTOR for full control of ejection force
- PACHMAYR® DECELERATOR® RECOIL PAD for optimal protection against felt recoil

ALASKAN



- SATIN FINISH MONTE CARLO WALNUT STOCK WITH CUT CHECKERING places your eye in perfect alignment with open sights or a scope
- ALLOY ONE-PIECE BOTTOM METAL adds rigidity for better accuracy
- POLISHED METAL SURFACES add style and elegance
- FORGED STEEL RECEIVER WITH INTEGRAL RECOIL LUG is bedded front and rear to eliminate shifts in zero for exceptional long-range accuracy
- PRE-'64 STYLE CONTROLLED ROUND FEED WITH CLAW EXTRACTOR fully controls the cartridge from magazine, to chamber, to ejection

- THREE-POSITION SAFETY allows you to unload the chamber while on safe and shows safety status at a glance
- FREE-FLOATING BARREL for years of pinpoint accuracy
- RECESSED TARGET CROWN enhances accuracy and protects the rifling
- FOLDING ADJUSTABLE REAR SIGHT AND HOODED BRASS BEAD FRONT get you on target quickly
- M.O.A. TRIGGER SYSTEM with zero take-up, zero creep and zero overtravel gives you outstanding accuracy
- BLADE-TYPE EJECTOR for full control of ejection force
- PACHMAYR® DECELERATOR® RECOIL PAD for optimal protection against felt recoil



ADJUSTABLE FOLDING REAR SIGHT ON BARREL BOSS

"THE WINCHESTER MODEL 70® IS MORE THAN A TRADITION, MORE THAN AN ICON. IT IS THE AMERICAN EXPRESSION OF THE ULTIMATE RIFLEMAN'S RIFLE. DURABLE AND PORTABLE WITH RELIABLE, CONTROLLED ROUND FEEDING IN A CLASSIC CONFIGURATION — THE MODEL 70 KINDLES DREAMS OF HUNTING ADVENTURE."
— Ron Spomer • Winchester World of Whitetail



ITEM NUMBER	CALIBER	MAGAZINE CAPACITY	BARREL LENGTH	OVERALL LENGTH	LENGTH OF PULL	DROP AT COMB	DROP AT HEEL	SIGHT RADIUS	NOMINAL WT. (LBS)	RATE OF TWIST	SUGGESTED RETAIL
MODEL 70 SAFARI EXPRESS											
535204161	375 H&H Mag	3	24"	44 3/4"	13 3/4"	1/2"	1/2"	18"	9	12"	\$1,559.99
535204199	416 Rem Mag	3	24"	44 3/4"	13 3/4"	1/2"	1/2"	18"	9	14"	1,559.99
535204144	458 Win Mag	3	24"	44 3/4"	13 3/4"	1/2"	1/2"	18"	9	14"	1,559.99

ITEM NUMBER	CALIBER	MAGAZINE CAPACITY	BARREL LENGTH	OVERALL LENGTH	LENGTH OF PULL	DROP AT COMB	DROP AT HEEL	SIGHT RADIUS	NOMINAL WT. (LBS)	RATE OF TWIST	SUGGESTED RETAIL
MODEL 70 ALASKAN											
535205128	30-06 Sprg	5	25"	45 3/4"	13 3/4"	5/8"	5/8"	18 1/2"	8 1/2	10"	\$1,399.99
535205133	300 Win Mag	3	25"	45 3/4"	13 3/4"	5/8"	5/8"	18 1/2"	8 1/2	10"	1,399.99
535205136	338 Win Mag	3	25"	45 3/4"	13 3/4"	5/8"	5/8"	18 1/2"	8 1/2	10"	1,399.99
535205138	375 H&H Mag	3	25"	45 3/4"	13 3/4"	5/8"	5/8"	18 1/2"	8 1/2	12"	1,439.99

*DROP AT MONTE CARLO IS 2"

FLOAT LIKE A FEATHER. AND HIT GAME LIKE A SLEDGEHAMMER.



"I'M ABSOLUTELY IN LOVE WITH MY WINCHESTER® MODEL 70: ITS LIGHTWEIGHT DESIGN AND INCREDIBLE ACCURACY MAKE IT THE ULTIMATE RIFLE FOR ANY SERIOUS WHITETAILER. I OWN TWO MODEL 70S CHAMBERED IN 243 WINCHESTER, AND OFTEN I CAN'T DECIDE WHICH ONE TO PICK UP WHEN I GO AFIELD. TIME AND AGAIN I FIND MYSELF GRABBING THE WALNUT STOCK VERSION, AND IT HAS NEVER LET ME DOWN!"
— Terry Drury • Drury Outdoors



FEATHERWEIGHT



- SATIN FINISH WALNUT STOCK WITH CLASSIC FEATHERWEIGHT CUT CHECKERING AND SCHNABEL FORE-END create the iconic Featherweight look
- POLISHED METAL SURFACES add style and elegance
- ALLOY ONE-PIECE BOTTOM METAL adds rigidity for better accuracy
- FORGED STEEL RECEIVER WITH INTEGRAL RECOIL LUG is bedded front and rear to eliminate shifts in zero for exceptional long-range accuracy
- PRE-'64 STYLE CONTROLLED ROUND FEED WITH CLAW EXTRACTOR fully controls the cartridge from magazine, to chamber, to ejection

- THREE-POSITION SAFETY allows you to unload the chamber while on safe and shows safety status at a glance
- FREE-FLOATING FEATHERWEIGHT PROFILE BARREL for years of pinpoint accuracy
- RECESSED TARGET CROWN enhances accuracy and protects the rifling
- M.O.A. TRIGGER SYSTEM with zero take-up, zero creep and zero overtravel gives you outstanding accuracy
- BLADE-TYPE EJECTOR for full control of ejection force
- PACHMAYR® DECELERATOR® RECOIL PAD for optimal protection against felt recoil



FEATHERWEIGHT COMPACT



- SATIN FINISH WALNUT STOCK WITH CLASSIC FEATHERWEIGHT CUT CHECKERING AND SCHNABEL FORE-END create the iconic Featherweight look
- SHORTER 13" LENGTH OF PULL makes it perfect for younger shooters or those of smaller stature
- POLISHED METAL SURFACES add style and elegance
- ALLOY ONE-PIECE BOTTOM METAL adds rigidity for better accuracy
- FORGED STEEL SHORT ACTION RECEIVER WITH INTEGRAL RECOIL LUG is bedded front and rear to eliminate shifts in zero for exceptional long-range accuracy
- PRE-'64 STYLE CONTROLLED ROUND FEED WITH CLAW EXTRACTOR fully controls the cartridge from magazine, to chamber, to ejection

- THREE-POSITION SAFETY allows you to unload the chamber while on safe and shows safety status at a glance
- 20" FREE-FLOATING FEATHERWEIGHT PROFILE BARREL for years of pinpoint accuracy
- RECESSED TARGET CROWN enhances accuracy and protects the rifling
- M.O.A. TRIGGER SYSTEM with zero take-up, zero creep and zero overtravel gives you outstanding accuracy
- BLADE-TYPE EJECTOR for full control of ejection force
- PACHMAYR® DECELERATOR® RECOIL PAD for optimal protection against felt recoil

ITEM NUMBER	CALIBER	MAGAZINE CAPACITY	BARREL LENGTH	OVERALL LENGTH	LENGTH OF PULL	DROP AT COMB	DROP AT HEEL	NOMINAL WT. (LBS)	RATE OF TWIST	SUGGESTED RETAIL
MODEL 70 FEATHERWEIGHT										
535200210	22-250 Rem	5	22"	42 1/4"	13 3/4"	1/2"	3/4"	6 3/4	14"	\$1,009.99
535200212	243 Win	5	22"	42 1/4"	13 3/4"	1/2"	3/4"	6 3/4	10"	1,009.99
535200218	7mm-08 Rem	5	22"	42 1/4"	13 3/4"	1/2"	3/4"	6 3/4	9 1/2"	1,009.99
535200220	308 Win	5	22"	42 1/4"	13 3/4"	1/2"	3/4"	6 3/4	12"	1,049.99
535200220	308 Win	5	22"	42 1/4"	13 3/4"	1/2"	3/4"	7	10"	1,049.99
535200264	270 WSM	3	24"	44 1/4"	13 3/4"	1/2"	3/4"	7	10"	1,049.99
535200264	270 WSM	3	24"	44 1/4"	13 3/4"	1/2"	3/4"	7	10"	1,009.99
535200255	300 WSM	3	24"	44 1/4"	13 3/4"	1/2"	3/4"	7	10"	1,009.99
535200277	325 WSM	3	24"	44 1/4"	13 3/4"	1/2"	3/4"	7	10"	1,009.99
535200225	25-06 Rem	5	22"	42 3/4"	13 3/4"	1/2"	3/4"	7	10"	1,009.99
535200225	270 Win	5	22"	42 3/4"	13 3/4"	1/2"	3/4"	7	10"	1,049.99
535200228	30-06 Sprg	5	22"	42 3/4"	13 3/4"	1/2"	3/4"	7 1/4	9"	1,049.99
535200229	264 Win Mag	3	24"	44 3/4"	13 3/4"	1/2"	3/4"	7 1/4	10"	1,049.99
535200233	300 Win Mag	3	24"	44 3/4"	13 3/4"	1/2"	3/4"	7 1/4	10"	1,049.99
MODEL 70 FEATHERWEIGHT COMPACT										
535201210	22-250 Rem	5	20"	39 1/2"	13"	1/2"	3/4"	6 1/2	14"	\$1,009.99
535201212	243 Win	5	20"	39 1/2"	13"	1/2"	3/4"	6 1/2	10"	1,009.99
535201218	7mm-08 Rem	5	20"	39 1/2"	13"	1/2"	3/4"	6 1/2	9 1/2"	1,009.99
535201220	308 Win	5	20"	39 1/2"	13"	1/2"	3/4"	6 1/2	12"	1,009.99

(SCOPE AND MOUNTS SHOWN NOT INCLUDED)



GUTSY GUNS.

IT'S A TOUGH WORLD OUT THERE, AND THESE RIFLES HAVE THE GUTS TO TAKE IT ON.

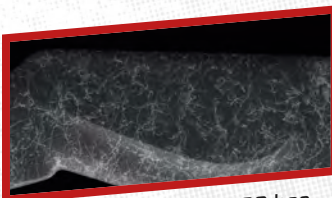

The Extreme Weather SS has a **SCULPTED CHEEKPIECE** that's beautifully functional, placing your eye in perfect alignment behind a scope.

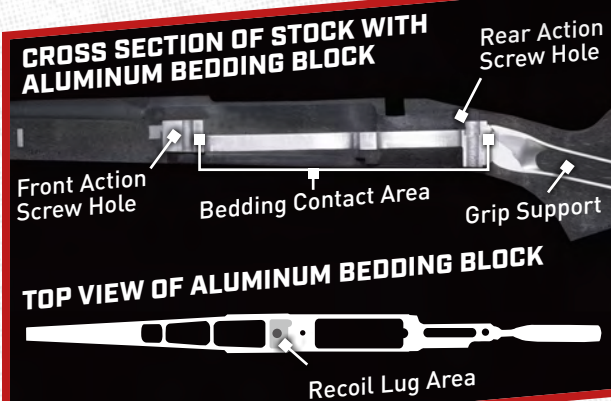

A **ONE-PIECE ALUMINUM BEDDING BLOCK** in the Extreme Weather SS and the Coyote Light is molded right into the stock during manufacturing, providing a solid, rigid base that ensures flat-out reliability. The rifle holds a tight zero, placing every shot where you aim — dead on, in any weather condition, in any season.



TIME TO GET EXTREME ON PREDATORS
Winchester® Varmint X® ammo is designed to devastate predators. Able to deliver extreme accuracy at extended ranges, the polymer tip bullet offers instant expansion for explosive terminal performance.

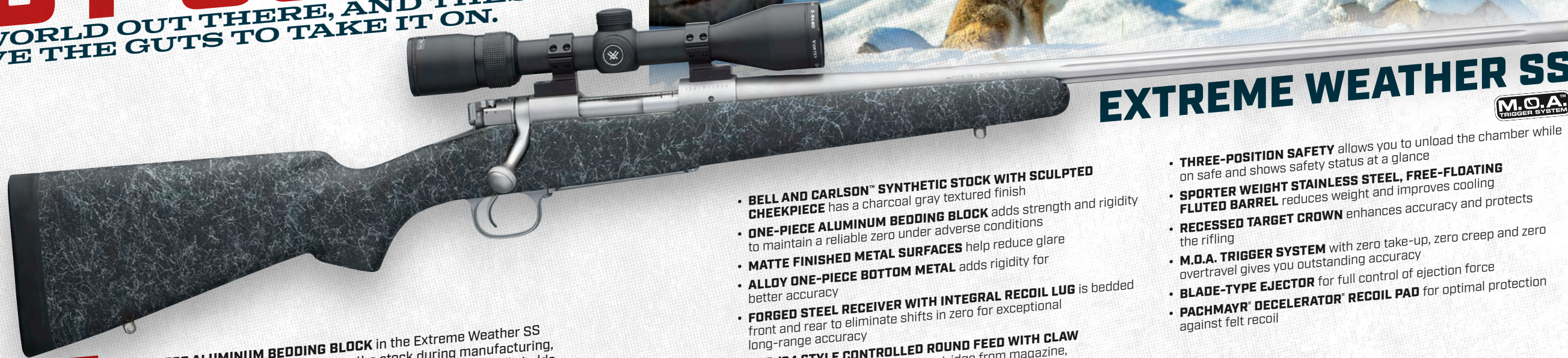

EXTREME WEATHER SS



- **BELL AND CARLSON™ SYNTHETIC STOCK WITH SCULPTED CHEEKPIECE** has a charcoal gray textured finish
- **ONE-PIECE ALUMINUM BEDDING BLOCK** adds strength and rigidity to maintain a reliable zero under adverse conditions
- **MATTE FINISHED METAL SURFACES** help reduce glare
- **ALLOY ONE-PIECE BOTTOM METAL** adds rigidity for better accuracy
- **FORGED STEEL RECEIVER WITH INTEGRAL RECOIL LUG** is bedded front and rear to eliminate shifts in zero for exceptional long-range accuracy
- **PRE-'64 STYLE CONTROLLED ROUND FEED WITH CLAW EXTRACTOR** fully controls the cartridge from magazine, to chamber, to ejection

- **THREE-POSITION SAFETY** allows you to unload the chamber while on safe and shows safety status at a glance
- **SPORTER WEIGHT STAINLESS STEEL, FREE-FLOATING FLUTED BARREL** reduces weight and improves cooling
- **RECESSED TARGET CROWN** enhances accuracy and protects the rifling
- **M.O.A. TRIGGER SYSTEM** with zero take-up, zero creep and zero overtravel gives you outstanding accuracy
- **BLADE-TYPE EJECTOR** for full control of ejection force
- **PACHMAYR® DECELERATOR® RECOIL PAD** for optimal protection against felt recoil



COYOTE LIGHT SR



- **BELL AND CARLSON™ SYNTHETIC STOCK** has a charcoal gray textured finish and multiple fore-end vents
- **ONE-PIECE ALUMINUM BEDDING BLOCK** adds strength and rigidity to maintain a reliable zero under adverse conditions
- **MATTE FINISHED METAL SURFACES** help reduce glare
- **ALLOY ONE-PIECE BOTTOM METAL** adds rigidity for better accuracy
- **DUAL FRONT SLING SWIVEL STUDS** for sling and bipod
- **FORGED STEEL RECEIVER WITH INTEGRAL RECOIL LUG** is bedded front and rear to eliminate shifts in zero for exceptional long-range accuracy
- **PRE-'64 STYLE CONTROLLED ROUND FEED WITH CLAW EXTRACTOR** fully controls the cartridge from magazine, to chamber, to ejection

- **THREE-POSITION SAFETY** allows you to unload the chamber while on safe and shows safety status at a glance
- **MEDIUM HEAVY STAINLESS STEEL, FREE-FLOATING FLUTED BARREL** reduces weight and improves cooling
- **RECESSED TARGET CROWN** enhances accuracy and protects the rifling
- **THREADED MUZZLE (5/8" X 24 TPI)** readily accepts an optional sound suppressor, muzzle brake or other accessory. Thread protector collar included.
- **M.O.A. TRIGGER SYSTEM** with zero take-up, zero creep and zero overtravel gives you outstanding accuracy
- **BLADE-TYPE EJECTOR** for full control of ejection force
- **PACHMAYR® DECELERATOR® RECOIL PAD** for optimal protection against felt recoil



(SCOPE AND MOUNTS SHOWN NOT INCLUDED.)

ITEM NUMBER	CALIBER	MAGAZINE CAPACITY	BARREL LENGTH	OVERALL LENGTH	LENGTH OF PULL	DROP AT COMB	DROP AT HEEL	NOMINAL WT. (LBS)	RATE OF TWIST	SUGGESTED RETAIL
MODEL 70 EXTREME WEATHER SS										
535206212	243 Win	5	22"	42 1/4"	13 3/4"	1/2"	1/2"	6 3/4	10"	\$1,339.99
535206218	7mm-08 Rem	5	22"	42 1/4"	13 3/4"	1/2"	1/2"	6 3/4	9 1/2"	1,339.99
535206220	308 Win	5	22"	42 1/4"	13 3/4"	1/2"	1/2"	6 3/4	12"	1,379.99
535206264	270 WSM	3	24"	44 1/4"	13 3/4"	1/2"	1/2"	7	10"	1,379.99
535206255	300 WSM	3	24"	44 1/4"	13 3/4"	1/2"	1/2"	7	10"	1,339.99
535206277	325 WSM	3	24"	44 1/4"	13 3/4"	1/2"	1/2"	7 1/8	10"	1,339.99
535206225	25-06 Rem	5	22"	42 3/4"	13 3/4"	1/2"	1/2"	7 1/8	10"	1,339.99
535206226	270 Win	5	22"	42 3/4"	13 3/4"	1/2"	1/2"	7 1/8	9"	1,379.99
535206228	30-06 Sprg	5	22"	42 3/4"	13 3/4"	1/2"	1/2"	7 1/4	9 1/2"	1,379.99
535206229	264 Win Mag	3	26"	46 3/4"	13 3/4"	1/2"	1/2"	7 1/4	10"	1,379.99
535206230	7mm Rem Mag	3	26"	46 3/4"	13 3/4"	1/2"	1/2"	7 1/4	10"	1,379.99
535206233	300 Win Mag	3	26"	46 3/4"	13 3/4"	1/2"	1/2"	7 1/4	10"	1,379.99
535206236	338 Win Mag	3	26"	46 3/4"	13 3/4"	1/2"	1/2"	7 1/4	10"	1,379.99

(SCOPE AND MOUNTS SHOWN NOT INCLUDED.)

ITEM NUMBER	CALIBER	MAGAZINE CAPACITY	BARREL LENGTH	OVERALL LENGTH	LENGTH OF PULL	DROP AT COMB	DROP AT HEEL	NOMINAL WT. (LBS)	RATE OF TWIST	SUGGESTED RETAIL
MODEL 70 COYOTE LIGHT SUPPRESSOR READY										
535232210	22-250 Rem	5	24"	44"	13 1/2"	1/2"	1/2"	7 1/2	14"	\$1,269.99
535232212	243 Win	5	24"	44"	13 1/2"	1/2"	1/2"	7 1/2	10"	1,269.99
535232220	308 Win	5	24"	44"	13 1/2"	1/2"	1/2"	7 1/2	12"	1,309.99
535232264	270 WSM	3	24"	44"	13 1/2"	1/2"	1/2"	7 1/2	10"	1,309.99
535232255	300 WSM	3	24"	44"	13 1/2"	1/2"	1/2"	7 1/2	10"	1,309.99
535232277	325 WSM	3	24"	44"	13 1/2"	1/2"	1/2"	7 1/2	10"	1,309.99

GET REAL.

HERE'S SOME REAL WESTERN HISTORY YOU CAN HOLD IN BOTH HANDS.

The West is where American history was raised. It's where legend, myth, romance and reality rode side-by-side into the sunset. The rugged rifles made by Winchester Repeating Arms® were the Guns That Won the West. No other firearm brand brings the legacy of the Wild West to life like a real Winchester®. It's high time you saddled up and rode the range with these legendary long guns from Winchester Repeating Arms.



The **MODEL 1866** was the very first rifle to wear the Winchester brand. Its bright brass receiver was the basis for giving it the nickname of "Yellow Boy" and it became an instant favorite in the scabbards of cowboys and lawmen.



The **MODEL 1873** rifle is widely credited as being "The Gun that Won the West." Chambered in several popular handgun calibers of the cowboy era, it's been produced in carbine, rifle and musket models. Cowboy Action Shooters love the reliable Model 1873 because it fires the same ammo as their revolvers.



The **MODEL 1885 HIGH WALL** rifle was John M. Browning's first commercial firearm design for Winchester. This stout falling-block action is so versatile it's been chambered in pistol cartridges up to the powerful belted magnums. It's remained the gold standard of single shot rifles for more than 125 years.

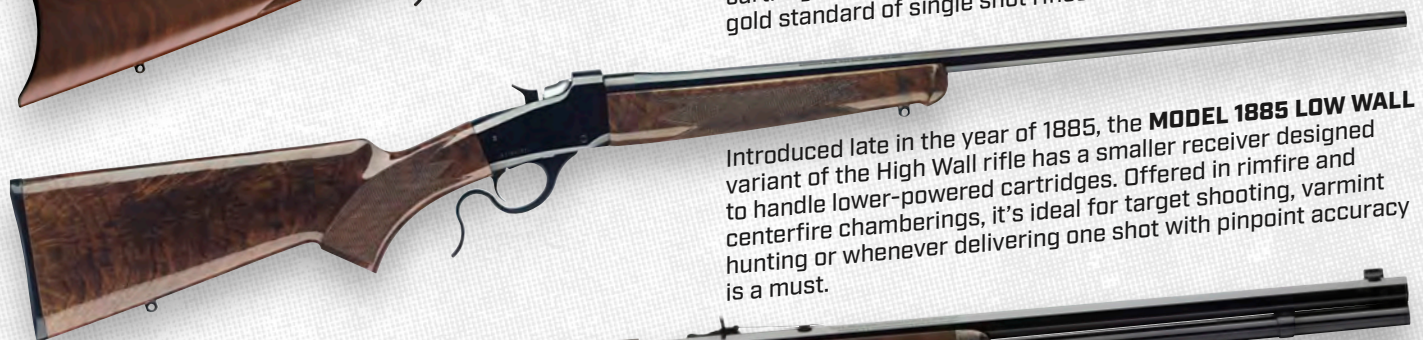

Introduced late in the year of 1885, the **MODEL 1885 LOW WALL** variant of the High Wall rifle has a smaller receiver designed to handle lower-powered cartridges. Offered in rimfire and centerfire chamberings, it's ideal for target shooting, varmint hunting or whenever delivering one shot with pinpoint accuracy is a must.



The **MODEL 1886** rifle was John M. Browning's second design for Winchester. Robust and accurate, it's capable of handling the long, powerful black powder "buffalo" cartridges popular on the Western Plains. The 45-70 Government is the all-time classic chambering for this legendary rifle design.

Please note that these firearms are representative of the legendary guns that make up the Winchester Repeating Arms® Historic product line. They are made in very limited quantities and will rotate in and out of production on an ongoing basis. **Thus not every gun shown here will be produced every year.** Available historic products for 2018 are shown on pages 22-35.



Winchester® historic rifles have long been offered with **TRADITIONAL BUTTPLATE DESIGNS** including a **CRESCENT METAL PLATE**, a **METAL CARBINE STRAP** and several variations of the classic flat **SHOTGUN BUTTPLATE**.



The **TRADITIONAL STRAIGHT GRIP** and **CURVED PISTOL GRIP** are two hallmarks of a genuine Winchester® rifle or carbine.

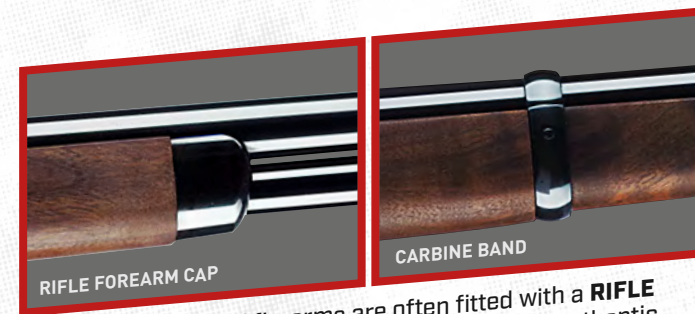

Classic Winchester® firearms are often fitted with a **RIFLE FOREARM CAP** or a **CARBINE BAND** to add that authentic touch every cowboy wants.

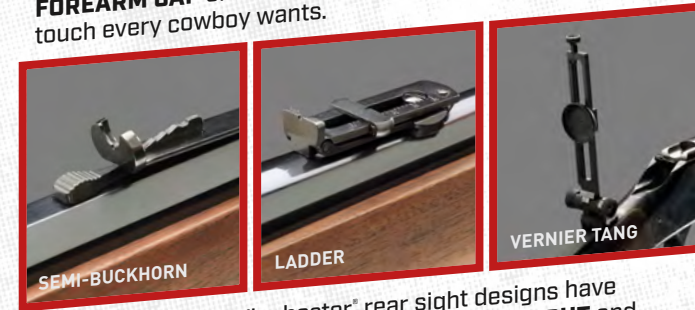

Over the decades Winchester® rear sight designs have included the **SEMI-BUCKHORN**, the **LADDER SIGHT** and the **VERNIER TANG** or **TANG PEEP SIGHT**.



The **MODEL 1892™** carbine is the classic American saddle gun. Designed for shorter pistol-class cartridges, it allowed a working cowboy to have a revolver and rifle chambered for the same ammunition. From the silent film era to today's epic blockbusters, the Model 1892 is the all-time iconic lever-action of American Western cinema.

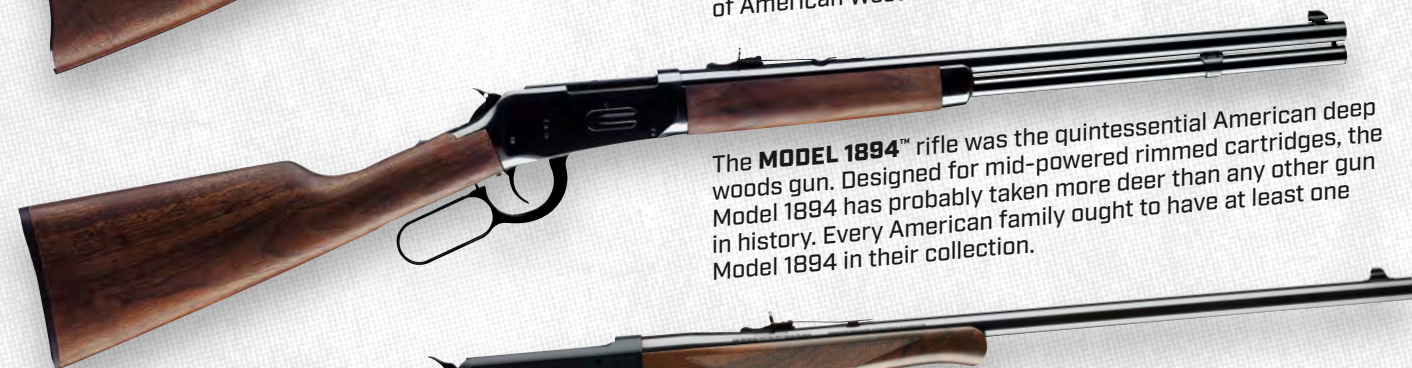

The **MODEL 1894™** rifle was the quintessential American deep woods gun. Designed for mid-powered rimmed cartridges, the Model 1894 has probably taken more deer than any other gun in history. Every American family ought to have at least one Model 1894 in their collection.



The **MODEL 1895™** rifle was designed with an internal box magazine, allowing the use of pointed bullets and the then-new bottleneck cartridges loaded with smokeless powder. Theodore Roosevelt called it his "Medicine Gun" and used it with great success on his 1909 African safari.



The **MODEL 71™** rifle is a modified version of the Model 1886 introduced by Winchester® in 1935. It's chambered for the robust 348 Winchester cartridge. Designed for taking deer, black bear and even moose, the Model 71 is also perfect for taking a trophy boar on your next wild hog hunt.

MODEL 1866

YELLOW BOY.

OWN THE LEGENDARY WINCHESTER® RIFLE THAT STARTED IT ALL.



SHORT RIFLE

- **GRADE I AMERICAN BLACK WALNUT STRAIGHT GRIP STOCK** with a satin oil finish that's velvet smooth to the touch
- **CLASSIC RIFLE-STYLE FOREARM** with polished brass forearm cap for the timeless look and feel of the original Model 1866
- **FULL BRIGHT POLISH** gives a deep, traditional glow to the brass receiver, crescent buttplate and forearm cap
- **CRESCENT BRASS BUTTPLATE** slips right into your shoulder for a more solid hold from any shooting position
- **FOLDING LADDER REAR SIGHT WITH MARBLE ARMS' GOLD BEAD FRONT SIGHT** get you on target quickly

- **OPEN TOP EJECTION PORT** for easier single cartridge loading and smoother, more reliable ejection of fired cases
- **FULL-LENGTH MAGAZINE TUBE** aids in offhand balance and provides plenty of ammo capacity for hunting, competition and casual plinking
- **BLUED STEEL LOADING GATE** allows for smoother loading and adds a touch of contrast against the highly polished brass receiver
- **BLUED STEEL ACTION SCREWS** create an added touch of tasteful contrast against the surface of the polished brass receiver

ITEM NUMBER	CALIBER	MAGAZINE CAPACITY	BARREL LENGTH	OVERALL LENGTH	LENGTH OF PULL	DROP AT COMB	DROP AT HEEL	NOMINAL WT. (LBS)	RATE OF TWIST	SUGGESTED RETAIL
MODEL 1866 SHORT RIFLE										
534244188	38 Spcl	11	20"	39"	13"	1 3/4"	3"	7 1/4	18 3/4"	\$1,299.99
534244140	44-40 Win	10	20"	39"	13"	1 3/4"	3"	7 1/4	26"	1,299.99
NEW 534244141	45 Colt	10	20"	39"	13"	1 3/4"	3"	7 1/4	26"	1,299.99

SHORT STUFF.

THESE SHORT RIFLES AND CARBINES ARE LONG ON LEGEND.



TRADITIONAL DUST COVER

ULTRA-SMOOTH ACTION

BRASS CARTRIDGE LIFTER



NEW CARBINE

- WALNUT STRAIGHT GRIP STOCK with a satin oil finish that's velvet smooth to the touch
- CLASSIC CARBINE-STYLE FOREARM with a blued barrel band for the timeless look and feel of the original Model 1873 carbines
- BLUED STEEL CARBINE STRAP BUTTPLATE slips into your shoulder for a solid hold

- BLUED STEEL CARBINE SADDLE RING lets you secure your carbine to your saddle rigging
- LADDER STYLE REAR SIGHT AND BLADE FRONT SIGHT get you on target quickly
- STEEL LOADING GATE for smoother loading
- RECEIVER TOP TANG is drilled and tapped for an optional tang-mounted rear sight for a more precise sight picture



SHORT RIFLE COLOR CASE HARDENED

- WALNUT STRAIGHT GRIP STOCK with a satin oil finish that's velvet smooth to the touch
- CLASSIC RIFLE-STYLE FOREARM with color case hardened cap for the timeless look and feel of the original Model 1873
- MAGNIFICENT COLOR CASE HARDENING on the robust steel receiver
- COLOR CASE HARDENED STEEL CRESCENT BUTTPLATE slips into your shoulder for a solid hold

- SEMI-BUCKHORN REAR SIGHT WITH MARBLE ARMS' GOLD BEAD FRONT SIGHT get you on target quickly
- STEEL LOADING GATE for smoother loading
- RECEIVER TOP TANG is drilled and tapped for an optional tang-mounted rear sight for a more precise sight picture

SHORT RIFLE

- WALNUT STRAIGHT GRIP STOCK with a satin oil finish that's velvet smooth to the touch
- CLASSIC RIFLE-STYLE FOREARM with blued steel cap for the timeless look and feel of the original Model 1873
- BLUED STEEL CRESCENT BUTTPLATE slips into your shoulder for a solid hold

- SEMI-BUCKHORN REAR SIGHT WITH MARBLE ARMS' GOLD BEAD FRONT SIGHT gets you on target quickly
- STEEL LOADING GATE for smoother loading
- BRASS CARTRIDGE LIFTER for more reliable feeding, even during the heat of cowboy action competition
- RECEIVER TOP TANG is drilled and tapped for an optional tang-mounted rear sight for a more precise sight picture

	ITEM NUMBER	CALIBER	MAGAZINE CAPACITY	BARREL LENGTH	OVERALL LENGTH	LENGTH OF PULL	DROP AT COMB	DROP AT HEEL	NOMINAL WT. (LBS)	RATE OF TWIST	SUGGESTED RETAIL
MODEL 1873 CARBINE											
NEW	534255137	357 Mag/38 Spl	10/11	20"	39"	13"	13/4"	3"	7 1/4	18 3/4"	\$1,299.99
NEW	534255140	44-40 Win	10	20"	39"	13"	13/4"	3"	7 1/4	26"	1,299.99
NEW	534255141	45 Colt	10	20"	39"	13"	13/4"	3"	7 1/4	26"	1,299.99
MODEL 1873 SHORT RIFLE COLOR CASE HARDENED											
	534202137	357 Mag/38 Spl	10/11	20"	39"	13"	13/4"	3"	7 1/4	18 3/4"	\$1,579.99
	534202140	44-40 Win	10	20"	39"	13"	13/4"	3"	7 1/4	26"	1,579.99
	534202141	45 Colt	10	20"	39"	13"	13/4"	3"	7 1/4	26"	1,579.99
MODEL 1873 SHORT RIFLE											
	534200137	357 Mag/38 Spl	10/11	20"	39"	13"	13/4"	3"	7 1/4	18 3/4"	\$1,299.99
	534200140	44-40 Win	10	20"	39"	13"	13/4"	3"	7 1/4	26"	1,299.99
	534200141	45 Colt	10	20"	39"	13"	13/4"	3"	7 1/4	26"	1,299.99

LONG RIDERS.

THESE ARE THE RIFLES THAT WON THE WEST.



SPORTER OCTAGON COLOR CASE HARDENED

- **GRADE II/III WALNUT STRAIGHT GRIP STOCK** with a satin oil finish that's velvet smooth to the touch
- **CLASSIC RIFLE-STYLE FOREARM** with forearm cap for the timeless look and feel of the original Model 1873
- **ELEGANT COLOR CASE HARDENING** on the robust steel receiver, lever, crescent buttplate and forearm cap protects against corrosion
- **CRESCENT BUTTPLATE** slips right into your shoulder for a more solid hold from any shooting position

- **SEMI-BUCKHORN REAR SIGHT WITH MARBLE ARMS® GOLD BEAD FRONT SIGHT** gets you on target quickly
- **STEEL LOADING GATE** for smoother loading
- **RECEIVER TOP TANG** is drilled and tapped for an optional tang-mounted rear sight that gives you a more precise sight picture and the timeless look and feel of shooting a long-barreled frontier rifle



FULL OCTAGON BARREL

DRILLED AND TAPPED TOP TANG

COLOR CASE HARDENING



SPORTER OCTAGON PISTOL GRIP COLOR CASE HARDENED



SPORTER OCTAGON PISTOL GRIP

- **GRADE II/III WALNUT PISTOL GRIP STOCK** with a satin oil finish that's velvet smooth to the touch
- **CLASSIC RIFLE-STYLE FOREARM** for the timeless look and feel of the original Model 1873
- **DEEPLY POLISHED BLUE OR COLOR CASE HARDENING** on the robust steel receiver, lever, crescent buttplate and forearm cap protect against corrosion
- **CRESCENT BUTTPLATE** slips right into your shoulder for a more solid hold from any shooting position

- **SEMI-BUCKHORN REAR SIGHT WITH MARBLE ARMS® GOLD BEAD FRONT SIGHT** gets you on target quickly
- **STEEL LOADING GATE** for smoother loading
- **RECEIVER TOP TANG** is drilled and tapped for an optional tang-mounted rear sight that gives you a more precise sight picture and the timeless look and feel of shooting a long-barreled frontier rifle

ITEM NUMBER	CALIBER	MAGAZINE CAPACITY	BARREL LENGTH	OVERALL LENGTH	LENGTH OF PULL	DROP AT COMB	DROP AT HEEL	NOMINAL WT. (LBS)	RATE OF TWIST	SUGGESTED RETAIL
MODEL 1873 SPORTER OCTAGON COLOR CASE HARDENED										
534217137	357 Mag/38 Spl	13/14	24"	43"	13"	13/4"	3"	7 1/2	18 3/4"	\$1,739.99
534217140	44-40 Win	13	24"	43"	13"	13/4"	3"	7 1/2	26"	1,739.99
534217141	45 Colt	13	24"	43"	13"	13/4"	3"	7 1/4	26"	1,739.99

ITEM NUMBER	CALIBER	MAGAZINE CAPACITY	BARREL LENGTH	OVERALL LENGTH	LENGTH OF PULL	DROP AT COMB	DROP AT HEEL	NOMINAL WT. (LBS)	RATE OF TWIST	SUGGESTED RETAIL
MODEL 1873 SPORTER OCTAGON PISTOL GRIP COLOR CASE HARDENED										
534228137	357 Mag/38 Spl	13/14	24"	43"	13"	13/4"	3"	8	18 3/4"	\$1,739.99
534228140	44-40 Win	13	24"	43"	13"	13/4"	3"	8	26"	1,739.99
534228141	45 Colt	13	24"	43"	13"	13/4"	3"	8	26"	1,739.99
MODEL 1873 SPORTER OCTAGON PISTOL GRIP										
534229137	357 Mag/38 Spl	13/14	24"	43"	13"	13/4"	3"	8	18 3/4"	\$1,469.99
534229140	44-40 Win	13	24"	43"	13"	13/4"	3"	8	26"	1,469.99
534229141	45 Colt	13	24"	43"	13"	13/4"	3"	8	26"	1,469.99

HOLD ON.

THESE BEAUTIES RUN THE GAMUT FROM RIMFIRES TO ROARING 45-70S.



Model 1885

HUNTER RIMFIRE

- CHECKERED WALNUT PISTOL GRIP STOCK with an oil finish that's velvet smooth to the touch
- TIMELESS SCHNABEL STYLE FOREARM with cut checkering sets the Hunter Rimfire apart from other rifles
- PACHMAYR® RUBBER BUTTPAD for non-slip shooting comfort
- OCTAGON 24" BARREL is button rifled for outstanding accuracy

NOTE: REAR SIGHT HAS BEEN REMOVED TO ALLOW THE SCOPE TO BE MOUNTED.

- SEMI-BUCKHORN REAR SIGHT WITH MARBLE ARMS® GOLD BEAD FRONT SIGHT get you on target quickly
- CURVED BLUED STEEL FINGER LEVER is comfortable in the hand and smoothly activates the steel falling breechblock for loading and ejection
- BLUED STEEL RECEIVER AND BARREL are drilled and tapped for scope mounting



Model 1886

DELUXE RIFLE

- HIGH GRADE III/IV SATIN FINISH WALNUT STOCK for deep grain beauty, with classic cut checkering for a sure grip
- PISTOL GRIP for good looks, improved grip and fast handling
- STEEL CRESCENT BUTTPLATE adds a traditional look while protecting the buttstock
- COLOR CASE HARDENING on the robust steel receiver, lever, crescent buttplate, grip cap, lower tang and forearm cap protect against corrosion

- MARBLE ARMS® FRONT SIGHT with brass bead for easier sighting
- ADJUSTABLE REAR SIGHT gets you on target with any ammo
- STEEL LOADING GATE for smoother loading
- BARREL is button-rifled for ultimate accuracy
- RECEIVER is drilled and tapped for an optional receiver mounted peep sight for a more precise sight picture



SHORT RIFLE

- SATIN FINISH WALNUT STOCK for classic beauty
- STRAIGHT GRIP for genuine good looks and fast handling
- STEEL CRESCENT BUTTPLATE adds traditional look while protecting the buttstock
- MARBLE ARMS® FRONT SIGHT with brass bead for easier sighting
- ADJUSTABLE REAR SIGHT gets you on target with any ammo
- STEEL LOADING GATE for smoother loading
- BARREL is button-rifled with a recessed crown for ultimate accuracy
- RECEIVER is drilled and tapped for an optional receiver mounted peep sight for a more precise sight picture

Model 1886

ITEM NUMBER	CALIBER	MAGAZINE CAPACITY	BARREL LENGTH	OVERALL LENGTH	LENGTH OF PULL	DROP AT COMB	DROP AT HEEL	NOMINAL WT. (LBS)	RATE OF TWIST	SUGGESTED RETAIL
MODEL 1885 LOW WALL HUNTER RIMFIRE										
524100170	17 HMR	N/A	24"	40"	13 1/2"	3/4"	1 1/4"	7 1/2"	9"	\$1,469.99
524100186	17 WSM	N/A	24"	40"	13 1/2"	3/4"	1 1/4"	7 1/2"	9"	1,469.99
524100102	22 LR	N/A	24"	40"	13 1/2"	3/4"	1 1/4"	7 1/2"	16"	1,469.99
524100104	22 WMR	N/A	24"	40"	13 1/2"	3/4"	1 1/4"	7 1/2"	16"	1,469.99
MODEL 1886 DELUXE RIFLE										
534227142	45-70 Govt	8	24"	43"	13 1/4"	1 1/4"	2"	8 3/8"	20"	\$1,739.99
MODEL 1886 SHORT RIFLE										
534175142	45-70 Govt	8	24"	43"	13 1/4"	1 1/4"	2"	8 3/8"	20"	\$1,339.99

(SCOPE AND MOUNTS SHOWN NOT INCLUDED)

LEVERAGE.

LEGENDARY SADDLE GUNS THAT BEAR THE WINCHESTER® NAME.



SHORT RIFLE

- **WALNUT STRAIGHT GRIP STOCK** with a satin finish that's velvet smooth to the touch
- **CLASSIC RIFLE-STYLE FOREARM** with blued steel cap for the timeless look and feel of the original Model 1892™ rifle
- **BLUED STEEL CRESCENT BUTTPLATE** slips into your shoulder for a solid hold

- **SEMI-BUCKHORN REAR SIGHT WITH MARBLE ARMS® GOLD BEAD FRONT SIGHT** gets you on target quickly
- **STEEL LOADING GATE** for smoother loading
- **TOP TANG** is drilled and tapped for an optional receiver mounted peep sight for a more precise sight picture



NEW CARBINE

- **WALNUT STRAIGHT GRIP STOCK** with a satin finish that's velvet smooth to the touch
- **CLASSIC CARBINE-STYLE FOREARM** with blued steel barrel band for the timeless look and feel of the original Model 1892™ carbine
- **BLUED STEEL CARBINE STRAP BUTTPLATE** slips into your shoulder for a solid hold

- **LADDER REAR SIGHT WITH MARBLE ARMS® GOLD BEAD FRONT SIGHT** gets you on target quickly
- **STEEL LOADING GATE** for smoother loading
- **TOP TANG** is drilled and tapped for an optional receiver mounted peep sight for a more precise sight picture



	ITEM NUMBER	CALIBER	MAGAZINE CAPACITY	BARREL LENGTH	OVERALL LENGTH	LENGTH OF PULL	DROP AT COMB	DROP AT HEEL	NOMINAL WT. (LBS)	RATE OF TWIST	SUGGESTED RETAIL
MODEL 1892 SHORT RIFLE											
	534162137	357 Mag	10	20"	37 1/2"	12 3/4"	11/8"	13/4"	6	26"	\$1,069.99
	534162124	44 Rem Mag	10	20"	37 1/2"	12 3/4"	11/8"	13/4"	6	26"	1,069.99
	534162141	45 Colt	10	20"	37 1/2"	12 3/4"	11/8"	13/4"	6	26"	1,069.99
MODEL 1892 CARBINE											
NEW	534177137	357 Mag	10	20"	37 1/2"	12 3/4"	11/8"	13/4"	6	18 3/4"	\$1,069.99
NEW	534177124	44 Rem Mag	10	20"	37 1/2"	12 3/4"	11/8"	13/4"	6	26"	1,069.99
NEW	534177140	44-40	10	20"	37 1/2"	12 3/4"	11/8"	13/4"	6	26"	1,069.99
NEW	534177141	45 Colt	10	20"	37 1/2"	12 3/4"	11/8"	13/4"	6	26"	1,069.99

GAME CHANGER.

TWO ROUGH AND READY LEVER RIFLES.

If you want a truly compact rifle that you can stuff into your backpack, wrap in your bedroll, strap to your ATV or tuck behind the seat of your truck, boat or bush plane, the **MODEL 94 TAKEDOWN** is what you want. It comes apart with just a quick twist into two compact components — the barrel assembly and the stocked receiver assembly. **REASSEMBLY** is easy. Put the two pieces together, give the end of the magazine tube a few turns and you instantly have a full-length rifle with the same superb accuracy as the other Model 94 models.

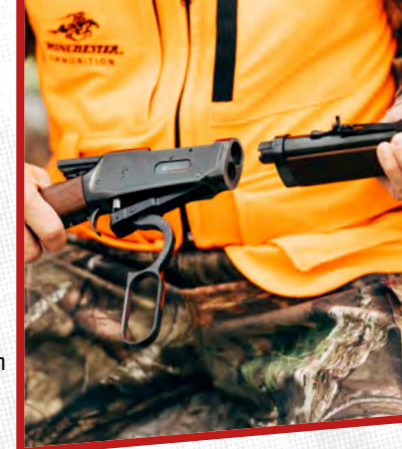

BARREL PORTS ease felt recoil and reduce muzzle jump on models chambered in 450 Marlin.



PACHMAYR DECELERATOR RECOIL PAD is a welcome addition to models chambered in 450 Marlin.



TRAILS END TAKEDOWN

- **WALNUT STOCK** with satin finish, authentic straight-grip styling and a blued steel forearm cap offer a nostalgic look
- **TRADITIONAL TAKEDOWN MECHANISM** is fast and easy to operate
- **TRIPLE-CHECKED BUTTON RIFLED BARREL** for the ultimate in accuracy and precision
- **ROUND LOCKING BOLT TRUNNIONS** help ensure a smooth, quick lever throw
- **BOLT RELIEF CUT** reduces hammer drag for smoother cocking
- **RADIUSED LEVER EDGES** give added protection to your fingers

- **HAMMER** is drilled and tapped for a **KNURLED HAMMER SPUR EXTENSION** (included) to aid in cocking and decocking the hammer when a scope is mounted
- **MARBLE ARMS FRONT SIGHT AND ADJUSTABLE SEMI-BUCKHORN REAR SIGHT** get you on target quickly
- **STEEL LOADING GATE** for smoother loading
- **ARTICULATED CARTRIDGE STOP** improves feeding reliability without damaging cartridges
- **DRILLED AND TAPPED FOR SCOPE MOUNTS** to easily attach your favorite optics

CARBINE

- **WALNUT STOCK** with satin finish, authentic straight-grip styling and a blued steel forearm band offer a nostalgic look
- **BLUED STEEL CARBINE STRAP BUTTPLATE** for smooth and easy shouldering
- **TRIPLE-CHECKED BUTTON RIFLED BARREL** for the ultimate in accuracy and precision
- **ROUND LOCKING BOLT TRUNNIONS** help ensure a smooth, quick lever throw
- **BOLT RELIEF CUT** reduces hammer drag for smoother cocking
- **RADIUSED LEVER EDGES** give added protection to your fingers

- **HAMMER** is drilled and tapped for a **KNURLED HAMMER SPUR EXTENSION** (included) to aid in cocking and decocking the hammer when a scope is mounted
- **MARBLE ARMS FRONT SIGHT AND ADJUSTABLE SEMI-BUCKHORN REAR SIGHT** get you on target quickly
- **STEEL LOADING GATE** for smoother loading
- **ARTICULATED CARTRIDGE STOP** improves feeding reliability without damaging cartridges
- **DRILLED AND TAPPED FOR SCOPE MOUNTS** to easily attach your favorite optics

ITEM NUMBER	CALIBER	MAGAZINE CAPACITY	BARREL LENGTH	OVERALL LENGTH	LENGTH OF PULL	DROP AT COMB	DROP AT HEEL	NOMINAL WT. (LBS)	RATE OF TWIST	SUGGESTED RETAIL
MODEL 94 TRAILS END TAKEDOWN										
534191114	30-30 Win	6	20"	38"	13 1/2"	11/4"	1 3/4"	6 3/4	12"	\$1,459.99
534191117	38-55 Win	6	20"	38"	13 1/2"	11/4"	1 3/4"	6 3/4	15"	1,459.99
534191160	450 Marlin	6	20"	38"	13 1/2"	11/4"	1 3/4"	6 3/4	20"	1,459.99
MODEL 94 CARBINE										
534199114	30-30 Win	7	20"	38"	13 1/2"	11/4"	1 3/4"	6 1/2	12"	\$1,199.99
534199117	38-55 Win	7	20"	38"	13 1/2"	11/4"	1 3/4"	6 1/2	15"	1,199.99

PURE '94.

THE WORLD'S MOST LEGENDARY LEVER-ACTION IS YOURS TO ENJOY.



BARREL PORTS ease felt recoil and reduce muzzle jump on models chambered in 450 Marlin.



PACHMAYR® DECELERATOR RECOIL PAD is a welcome addition to models chambered in 450 Marlin.

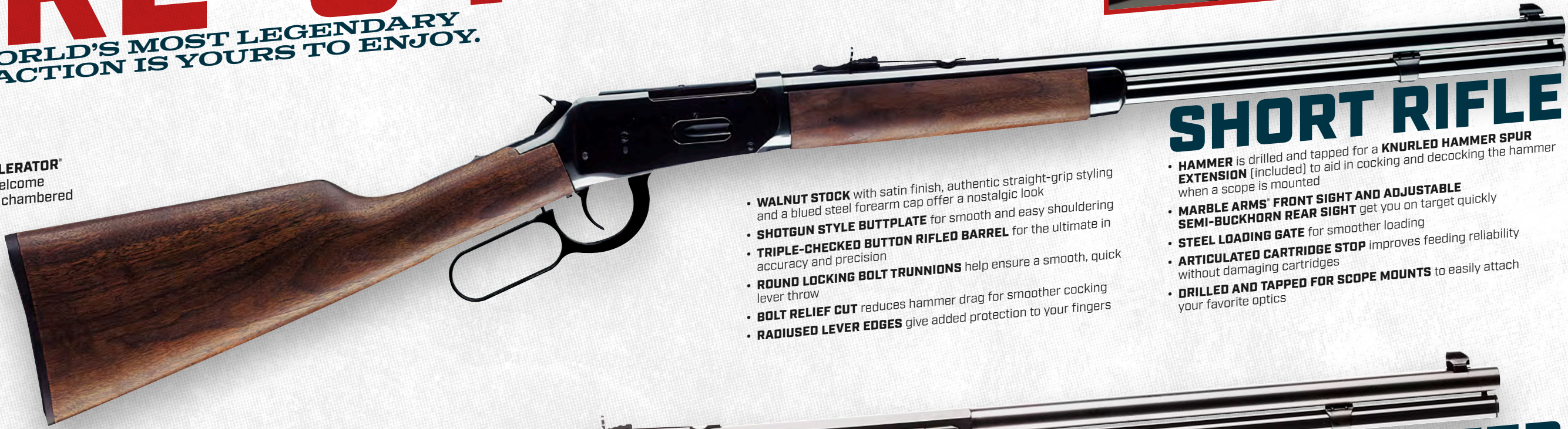

SHORT RIFLE

- **WALNUT STOCK** with satin finish, authentic straight-grip styling and a blued steel forearm cap offer a nostalgic look
- **SHOTGUN STYLE BUTTPLATE** for smooth and easy shouldering
- **TRIPLE-CHECKED BUTTON RIFLED BARREL** for the ultimate in accuracy and precision
- **ROUND LOCKING BOLT TRUNNIONS** help ensure a smooth, quick lever throw
- **BOLT RELIEF CUT** reduces hammer drag for smoother cocking
- **RADIUSED LEVER EDGES** give added protection to your fingers

- **HAMMER** is drilled and tapped for a **KNURLED HAMMER SPUR EXTENSION** (included) to aid in cocking and decocking the hammer when a scope is mounted
- **MARBLE ARMS® FRONT SIGHT AND ADJUSTABLE SEMI-BUCKHORN REAR SIGHT** get you on target quickly
- **STEEL LOADING GATE** for smoother loading
- **ARTICULATED CARTRIDGE STOP** improves feeding reliability without damaging cartridges
- **DRILLED AND TAPPED FOR SCOPE MOUNTS** to easily attach your favorite optics



SPORTER

- **WALNUT STOCK** with satin finish, authentic straight-grip styling, bordered cut checkering and a blued steel forearm cap offer a nostalgic look
- **BLUED CRESCENT BUTTPLATE** slips firmly into your shoulder for a solid hold
- **TRIPLE-CHECKED HALF ROUND/HALF OCTAGON BUTTON RIFLED BARREL** for the ultimate in accuracy and precision
- **ROUND LOCKING BOLT TRUNNIONS** help ensure a smooth, quick lever throw
- **BOLT RELIEF CUT** reduces hammer drag for smoother cocking
- **RADIUSED LEVER EDGES** give added protection to your fingers

- **HAMMER** is drilled and tapped for a **KNURLED HAMMER SPUR EXTENSION** (included) to aid in cocking and decocking the hammer when a scope is mounted
- **MARBLE ARMS® FRONT SIGHT AND ADJUSTABLE SEMI-BUCKHORN REAR SIGHT** get you on target quickly
- **STEEL LOADING GATE** for smoother loading
- **ARTICULATED CARTRIDGE STOP** improves feeding reliability without damaging cartridges
- **DRILLED AND TAPPED FOR SCOPE MOUNTS** to easily attach your favorite optics

ITEM NUMBER	CALIBER	MAGAZINE CAPACITY	BARREL LENGTH	OVERALL LENGTH	LENGTH OF PULL	DROP AT COMB	DROP AT HEEL	NOMINAL WT. (LBS)	RATE OF TWIST	SUGGESTED RETAIL
MODEL 94 SHORT RIFLE										
534174114	30-30 Win	7	20"	38"	13 1/2"	11/4"	1 3/4"	6 3/4	12"	\$1,229.99
534174117	38-55 Win	7	20"	38"	13 1/2"	11/4"	1 3/4"	6 3/4	15"	1,229.99
534174160	450 Marlin	7	20"	38"	13 1/2"	11/4"	1 3/4"	6 3/4	20"	1,229.99
MODEL 94 SPORTER										
534178114	30-30 Win	8	24"	42 1/2"	13 1/2"	11/4"	1 3/4"	7 1/2	12"	\$1,399.99
534178117	38-55 Win	8	24"	42 1/2"	13 1/2"	11/4"	1 3/4"	7 1/2	15"	1,399.99

SUPER X⁴

DISCOVER WHY IT'S THE AUTOLOADING SHOTGUN THAT'S BUILT 4 SPEED.

Winchester Super X[®] autoloading shotguns have a worldwide reputation for speed, reliability and handling. The latest evolution of this popular series is the Super X⁴ and it's better than ever. The Super X⁴ is lighter, faster cycling, smoother swinging and more ergonomic. 2018 brings several new models for virtually every type of game. Here's why the Super X⁴ is the world-class autoloading shotgun that is BUILT 4 SPEED.



One of the first things experienced shooters notice about the new Super X⁴ is the gun's **IMPROVED ERGONOMICS**. It's **LIGHTER OVERALL** and **THE PISTOL GRIP IS ROUNDER AND MORE COMFORTABLE**, regardless of which hand you use to pull the trigger. The gun's overall balance point has been moved slightly forward to **CREATE A MORE FLUID SWING, BETTER TARGET TRACKING AND SMOOTHER FOLLOW-THROUGH**.



The fit and balance of a shotgun stock are critical factors of how well you're able to shoot it. The new Super X⁴ comes with polymer **LENGTH OF PULL SPACERS** that fit between the stock and the recoil pad. When adjusted properly, you shoulder the shotgun with a smooth confidence and "felt recoil" is greatly diminished. Synthetic stock Super X⁴ models come with one spacer already installed to provide a standard 14 1/4" length of pull, and include one additional spacer in the box. Wood stock models include two length of pull spacers in the box. When you remove or add a spacer, you change the length of pull by 1/4". Additional spacers are available from your Winchester Repeating Arms dealer, allowing you to custom fit the Super X⁴ to your exact length of pull.

The newest evolution of the **INFLEX TECHNOLOGY RECOIL PAD ON THE SUPER X⁴ FURTHER REDUCES "FELT RECOIL"**. Specially shaped rib structures located inside the pad help direct and channel the recoil impulse, moving the comb down and away from your cheek to reduce "felt recoil" to very manageable levels, even when shooting heavy magnum loads. The new pad's **LARGER FOOTPRINT SPREADS RECOIL FORCES OVER A WIDER AREA** for further cushioning.



The new Super X⁴ features a **SPRING-LOADED EJECTOR** that throws the empty shell out of the ejection port as soon as it clears the chamber for faster, more reliable operation, regardless of shell length.



The new Super X⁴ features a **LARGER BOLT HANDLE** and an **OVERSIZED BOLT RELEASE BUTTON** for easier engagement and faster operation; two very important features when your hands are cold and wet or when you're wearing gloves. The carrier and bolt release button are coated with nickel Teflon[®] to reduce friction and help prevent corrosion.



The larger, easier to operate **AMBIDEXTROUS SAFETY** button on the Super X⁴ is located at the rear of the angular-profile trigger guard and is easily reversible for both right- or left-handed shooters. The opening on **THE TRIGGER GUARD IS GENEROUSLY SIZED FOR EASIER ACCESS**, even when wearing heavy gloves.

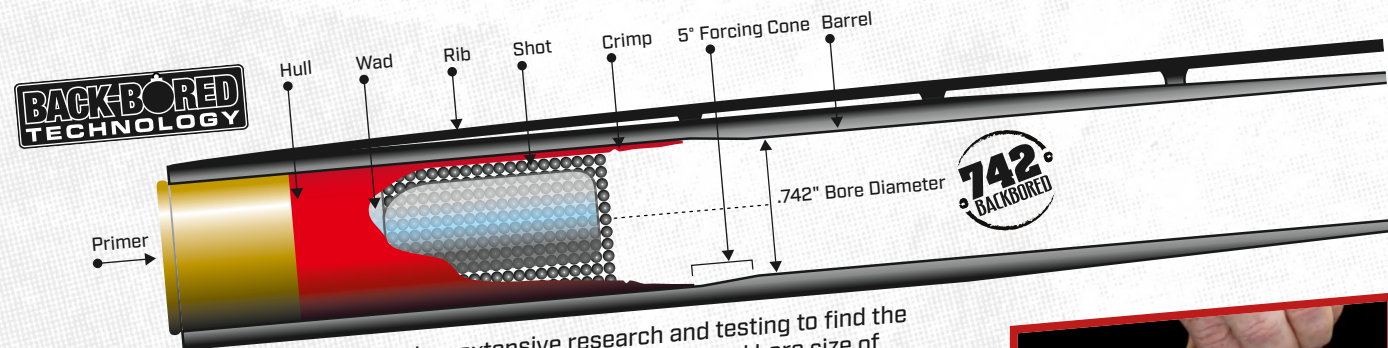

BACK-BORED TECHNOLOGY is based on extensive research and testing to find the secret to tighter, more consistent patterns. Instead of the traditional bore size of .729", this research shows the ideal 12 gauge interior diameter is .742". If the bore is any larger, the gases will blow by the shot cup and reduce pellet velocity. If the bore is too tight, the pellets are deformed as they pass through the forcing cone, causing poor ballistic performance.

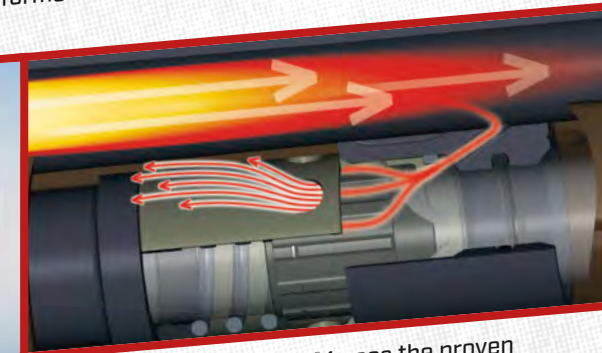

Like the original Super X³, the Super X⁴ uses the proven **ACTIVE VALVE GAS SYSTEM** that automatically self-adjusts to allocate the exact gas pressure necessary to reliably cycle a wide range of loads commonly used for hunting or target shooting. When firing the heaviest magnum loads in 3 1/2" models, gases vent upward and a portion of them are vented forward out the Quadra-Vent ports in the forearm to help regulate bolt speed. Both 3" and 3 1/2" Super X⁴ shotguns will reliably cycle even 1 1/8 oz., 2 3/4" light loads. Excess gases from heavy loads are channeled through the forward **QUADRA-VENT™** ports for cleaner and more reliable operation.



LOAD DIVERSITY means a Super X⁴ can reliably shoot them all, from light factory field shells to heavy magnum waterfowl and turkey loads. The proven Active Valve on the Super X⁴ makes it the most versatile autoloader on the range, in the marsh and in the field.



"AFTER SPENDING CONSIDERABLE TIME WITH THE NEW SUPER X⁴, ITS FEEL AND POINTABILITY ARE SECOND TO NONE."
— John Stephens • RNT-V



The Super X⁴ has a **DROP-OUT TRIGGER GROUP** that's easy to remove for detailed cleaning and lubrication. The **SELF-ALIGNING BOLT CARRIER LINK** makes it easy to reassemble.

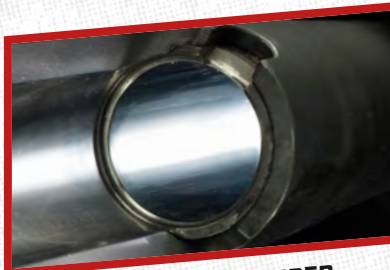

CHROME-PLATED CHAMBER AND BORE are critical for today's steel and Hi-Density (HD) shot. Hard chrome makes the surfaces highly resistant to wear and gives you superior protection from rust and corrosion. That's why all smoothbore Super X⁴ shotguns feature a hard-chromed chamber and bore.



From the duck blind to the firing line, the **INVECTOR-PLUS CHOKE TUBE SYSTEM** is the world's most consistent. Because the threads are located at the bottom of the choke tube they seal out corrosive gases better. The tube's thicker walls make Invector-Plus chokes much stronger than any other choke tube system, yet they remain easy to remove and clean. They are more concentric with the bore and thus produce more even, consistent shot patterns. The Super X⁴ comes with full, modified and improved cylinder flush-mounted choke tubes so your gun is ready for anything, right out of the box. [Additional choke tubes are available at your local Winchester Repeating Arms dealer.]

BIG HITTER.

OFFERS MAJOR LEAGUE CYCLING SPEED WITH A SMOOTH HOME RUN SWING.



- **SYNTHETIC STOCK WITH IMPROVED ERGONOMICS, A ROUNDED PISTOL GRIP AND TEXTURED GRIPPING SURFACES** gives your hands a sure, non-slip grip. The non-glare matte black finish won't spook wary game
- **BACK-BORED TECHNOLOGY** provides optimum shot patterns that are dense and even
- **INVECTOR-PLUS CHOKE TUBE SYSTEM** offers consistent patterns to match your target situation
- **HARD CHROME-PLATED CHAMBER AND BORE** make these surfaces highly resistant to wear and corrosion
- **TRUGLO[®] LONG BEAD[™] FIBER-OPTIC FRONT SIGHT** offers a true, precise sight picture
- **VENT RIB** gives you a smooth, clean sighting plane

SUPER X⁴



- **SELF-ADJUSTING ACTIVE VALVE SYSTEM** cycles a wide variety of loads while reducing "felt recoil"
- **QUADRA-VENT[™] PORTS** vent excess gases for cleaner operation
- **DROP-OUT TRIGGER GROUP** allows for easy cleaning
- **AMBIDEXTROUS CROSSBOLT SAFETY** is easily reversible
- **LARGER BOLT HANDLE AND BOLT RELEASE BUTTON** are faster and easier to operate
- **LENGTH OF PULL SPACERS** allow stock adjustments to achieve a perfect fit
- **INFLEX TECHNOLOGY RECOIL PAD** directs felt recoil down and away from your cheek to reduce flinch and fatigue



"NO MATTER THE CONDITIONS, THE SUPER X⁴, WHEN CALLED UPON, WILL DO ITS JOB EVERY TIME YOU PULL THE TRIGGER."
— Jim Ronquest • RNT-V

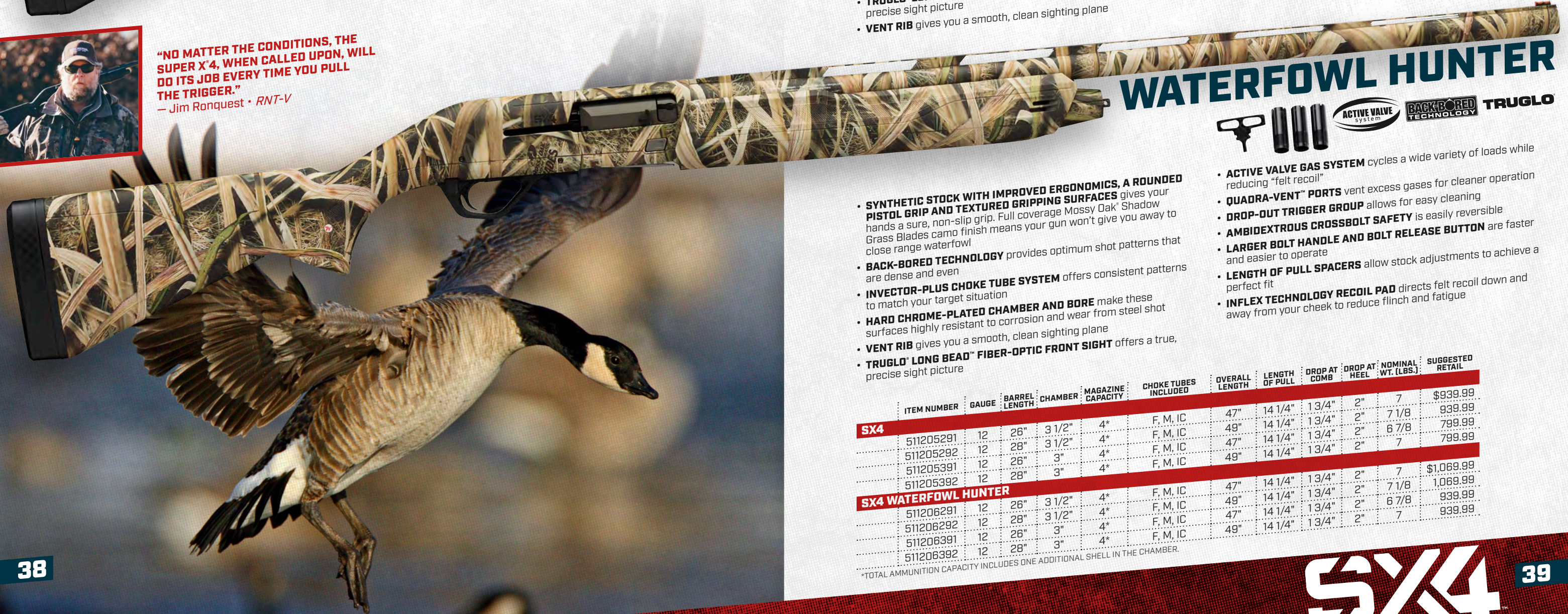

WATERFOWL HUNTER



- **SYNTHETIC STOCK WITH IMPROVED ERGONOMICS, A ROUNDED PISTOL GRIP AND TEXTURED GRIPPING SURFACES** gives your hands a sure, non-slip grip. Full coverage Mossy Oak[®] Shadow Grass Blades camo finish means your gun won't give you away to close range waterfowl
- **BACK-BORED TECHNOLOGY** provides optimum shot patterns that are dense and even
- **INVECTOR-PLUS CHOKE TUBE SYSTEM** offers consistent patterns to match your target situation
- **HARD CHROME-PLATED CHAMBER AND BORE** make these surfaces highly resistant to corrosion and wear from steel shot
- **VENT RIB** gives you a smooth, clean sighting plane
- **TRUGLO[®] LONG BEAD[™] FIBER-OPTIC FRONT SIGHT** offers a true, precise sight picture

- **ACTIVE VALVE GAS SYSTEM** cycles a wide variety of loads while reducing "felt recoil"
- **QUADRA-VENT[™] PORTS** vent excess gases for cleaner operation
- **DROP-OUT TRIGGER GROUP** allows for easy cleaning
- **AMBIDEXTROUS CROSSBOLT SAFETY** is easily reversible
- **LARGER BOLT HANDLE AND BOLT RELEASE BUTTON** are faster and easier to operate
- **LENGTH OF PULL SPACERS** allow stock adjustments to achieve a perfect fit
- **INFLEX TECHNOLOGY RECOIL PAD** directs felt recoil down and away from your cheek to reduce flinch and fatigue

	ITEM NUMBER	GAUGE	BARREL LENGTH	CHAMBER	MAGAZINE CAPACITY	CHOKE TUBES INCLUDED	OVERALL LENGTH	LENGTH OF PULL	DROP AT COMB	DROP AT HEEL	NOMINAL WT. (LBS.)	SUGGESTED RETAIL
SX4	511205291	12	26"	3 1/2"	4*	F, M, IC	47"	14 1/4"	1 3/4"	2"	7	\$939.99
	511205292	12	28"	3 1/2"	4*	F, M, IC	49"	14 1/4"	1 3/4"	2"	7 1/8	939.99
	511205391	12	26"	3"	4*	F, M, IC	47"	14 1/4"	1 3/4"	2"	6 7/8	799.99
	511205392	12	28"	3"	4*	F, M, IC	49"	14 1/4"	1 3/4"	2"	7	799.99
SX4 WATERFOWL HUNTER	511206291	12	26"	3 1/2"	4*	F, M, IC	47"	14 1/4"	1 3/4"	2"	7	\$1,069.99
	511206292	12	28"	3 1/2"	4*	F, M, IC	49"	14 1/4"	1 3/4"	2"	7 1/8	1,069.99
	511206391	12	26"	3"	4*	F, M, IC	47"	14 1/4"	1 3/4"	2"	6 7/8	939.99
	511206392	12	28"	3"	4*	F, M, IC	49"	14 1/4"	1 3/4"	2"	7	939.99

*TOTAL AMMUNITION CAPACITY INCLUDES ONE ADDITIONAL SHELL IN THE CHAMBER.

GAME TIME.

GET OFF THE BENCH AND GET IN THE GAME WITH THE SUPER X⁴.



NEW UNIVERSAL HUNTER



- **SYNTHETIC STOCK WITH IMPROVED ERGONOMICS, A ROUNDED PISTOL GRIP AND TEXTURED GRIPPING SURFACES** gives your hands a sure, non-slip grip. Full coverage Mossy Oak Break-Up Country[®] camo finish means your shotgun will help give you ultimate concealment
- **BACK-BORED TECHNOLOGY** provides optimum shot patterns that are dense and even
- **INVECTOR-PLUS CHOKE TUBE SYSTEM** offers consistent patterns to match your target situation
- **HARD CHROME-PLATED CHAMBER AND BORE** make these surfaces highly resistant to corrosion and wear from steel shot
- **VENT RIB** gives you a smooth, clean sighting plane
- **DRILLED AND TAPPED** receiver is ready for optics mounting

- **TRUGLO[®] LONG BEAD[™] FIBER-OPTIC FRONT SIGHT** offers a true, precise sight picture
- **ACTIVE VALVE GAS SYSTEM** cycles a wide variety of loads while reducing "felt recoil"
- **QUADRA-VENT[™] PORTS** vent excess gases for cleaner operation
- **DROP-OUT TRIGGER GROUP** allows for easy cleaning
- **AMBIDEXTROUS CROSSBOLT SAFETY** is easily reversible
- **LARGER BOLT HANDLE AND BOLT RELEASE BUTTON** are faster and easier to operate
- **LENGTH OF PULL SPACERS** allow stock adjustments to achieve a perfect fit
- **INFLEX TECHNOLOGY RECOIL PAD** directs felt recoil down and away from your cheek to reduce flinch and fatigue

EXTRA-FULL TURKEY CHOKE TUBE

A tight, dense pattern of heavy shot is critical for taking turkeys. You get an Invector-Plus Extra-Full Turkey choke tube standard with the Super X⁴ NWTF[®] Cantilever Turkey shotgun. The knurled friction band makes it easy to install and remove and the camo front band won't give you away to a sharp-eyed tom.



NWTF[®] CANTILEVER TURKEY



- **SYNTHETIC STOCK WITH IMPROVED ERGONOMICS, A ROUNDER PISTOL GRIP AND TEXTURED GRIPPING SURFACES** gives your hands a sure, non-slip grip and the non-glare Mossy Oak[®] Obsession[™] camo finish helps you hide from turkeys
- **BACK-BORED TECHNOLOGY** provides optimum shot patterns that are dense and even
- **INVECTOR-PLUS EXTRA-FULL TURKEY EXTENDED CHOKE TUBE** with camo front band produces a tight, tom-busting pattern
- **24" BARREL** is easy to swing in tight brush
- **HARD CHROME-PLATED CHAMBER AND BORE** make these surfaces highly resistant to wear and corrosion

- **TRUGLO[®] FIBER-OPTIC FRONT SIGHT WITH ADJUSTABLE REAR SIGHT** gathers light for quick target acquisition
- **WEAVER[®]-STYLE CANTILEVER RAIL DESIGN** makes it easy to attach an electronic sight or conventional scope
- **QUADRA-VENT[™] PORTS** vent excess gases for cleaner operation
- **DROP-OUT TRIGGER GROUP** allows for easy cleaning
- **AMBIDEXTROUS CROSSBOLT SAFETY** is easily reversible
- **LENGTH OF PULL SPACERS** allow stock adjustments to achieve a perfect fit
- **INFLEX TECHNOLOGY RECOIL PAD** directs felt recoil down and away from your cheek to reduce flinch and fatigue



NEW CANTILEVER BUCK



- **SYNTHETIC STOCK WITH IMPROVED ERGONOMICS, A ROUNDER PISTOL GRIP AND TEXTURED GRIPPING SURFACES** gives your hands a sure, non-slip grip and the non-glare matte black finish won't betray you to a big buck
- **RIFLED 22" BARREL** optimized for extreme accuracy with 2 3/4" and 3" sabots and slugs
- **MATTE BLACK RECEIVER** is strong, lightweight aluminum alloy for easy carrying
- **WEAVER[®]-STYLE CANTILEVER RAIL DESIGN** makes it easy to attach an electronic sight or conventional scope

- **TRUGLO[®] FIBER-OPTIC FRONT SIGHT** with adjustable rear sight gathers light for fast, quick pointing
- **SELF-ADJUSTING ACTIVE VALVE SYSTEM** cycles a wide variety of loads while reducing "felt recoil"
- **DROP-OUT TRIGGER GROUP** allows for easy cleaning
- **AMBIDEXTROUS CROSSBOLT SAFETY** is easily reversible
- **LENGTH OF PULL SPACERS** allow stock adjustments to achieve a perfect fit
- **INFLEX TECHNOLOGY RECOIL PAD** directs felt recoil down and away from your cheek to reduce flinch and fatigue



ITEM NUMBER	GAUGE	BARREL LENGTH	CHAMBER	MAGAZINE CAPACITY	CHOKE TUBES INCLUDED	OVERALL LENGTH	LENGTH OF PULL	DROP AT COMB	DROP AT HEEL	NOMINAL WT. (LBS.)	SUGGESTED RETAIL
SX4 NWTF CANTILEVER TURKEY											
NEW 511214290	12	24"	3 1/2"	4*	T	45"	14 1/4"	13/4"	2"	7 1/2	\$1,069.99
SX4 CANTILEVER BUCK											
NEW 511215340	12	22"	3"	4*	1:28" RH Twist	43"	14 1/4"	13/4"	2"	7 1/2	\$959.99
SX4 UNIVERSAL HUNTER											
NEW 511216290	12	24"	3 1/2"	4*	F, M, IC	45"	14 1/4"	13/4"	2"	6 7/8	\$1,069.99
NEW 511216291	12	26"	3 1/2"	4*	F, M, IC	47"	14 1/4"	13/4"	2"	7	1,069.99
NEW 511216292	12	28"	3 1/2"	4*	F, M, IC	49"	14 1/4"	13/4"	2"	7 1/8	1,069.99

*TOTAL AMMUNITION CAPACITY INCLUDES ONE ADDITIONAL SHELL IN THE CHAMBER.

CHECK IT OUT.

CHECKERED FINE WALNUT THAT'S BUILT 4 SPEED.



FIELD



- **SATIN OIL FINISH WALNUT STOCK WITH STRAIGHT LINE CUT CHECKERING, IMPROVED ERGONOMICS AND A ROUNDER PISTOL GRIP** improves control and looks elegant
- **MATTE BLACK RECEIVER** is strong, lightweight aluminum alloy to reduce weight for easy carrying
- **BACK-BORED TECHNOLOGY** provides optimum shot patterns that are dense and even
- **VENT RIB** gives you a smooth, clean sighting plane and helps reduce weight
- **TRUGLO® LONG BEAD™ FIBER-OPTIC FRONT SIGHT** offers a true, precise sight picture
- **HARD CHROME-PLATED CHAMBER AND BORE** make these surfaces highly resistant to wear and corrosion

- **INVECTOR-PLUS CHOKE TUBES** offer consistent, reliable patterns
- **ACTIVE VALVE SYSTEM** cycles a wide variety of loads while reducing "felt recoil"
- **INFLEX TECHNOLOGY RECOIL PAD** directs felt recoil down and away from your cheek to reduce flinch and fatigue
- **AMBIDEXTROUS CROSSBOLT SAFETY** is easily reversible
- **LARGER BOLT HANDLE AND BOLT RELEASE BUTTON** are faster and easier to operate
- **DROP-OUT TRIGGER GROUP** allows for easy cleaning



FIELD COMPACT



- **COMPACT 13" LENGTH OF PULL** to better fit smaller statured shooters. Two 1/4" spacers are included to create a more custom fit.
- **SATIN OIL FINISH WALNUT STOCK WITH STRAIGHT LINE CUT CHECKERING, IMPROVED ERGONOMICS AND A ROUNDER PISTOL GRIP** improves control and looks elegant
- **MATTE BLACK RECEIVER** is strong, lightweight aluminum alloy to reduce weight for easy carrying
- **BACK-BORED TECHNOLOGY** provides optimum shot patterns that are dense and even
- **VENT RIB** gives you a smooth, clean sighting plane and helps reduce weight
- **TRUGLO® LONG BEAD™ FIBER-OPTIC FRONT SIGHT** offers a true, precise sight picture

- **HARD CHROME-PLATED CHAMBER AND BORE** make these surfaces highly resistant to wear and corrosion
- **INVECTOR-PLUS CHOKE TUBES** offer consistent, reliable patterns
- **ACTIVE VALVE SYSTEM** cycles a wide variety of loads while reducing "felt recoil"
- **INFLEX TECHNOLOGY RECOIL PAD** directs felt recoil down and away from your cheek to reduce flinch and fatigue
- **AMBIDEXTROUS CROSSBOLT SAFETY** is easily reversible
- **LARGER BOLT HANDLE AND BOLT RELEASE BUTTON** are faster and easier to operate
- **DROP-OUT TRIGGER GROUP** allows for easy cleaning

ITEM NUMBER	GAUGE	BARREL LENGTH	CHAMBER	MAGAZINE CAPACITY	CHOKE TUBES INCLUDED	OVERALL LENGTH	LENGTH OF PULL	DROP AT COMB	DROP AT HEEL	NOMINAL WT. (LBS.)	SUGGESTED RETAIL
SX4 FIELD											
511210391	12	26"	3"	4*	F, M, IC	47"	14 1/4"	11/2"	13/4"	6 5/8	\$939.99
511210392	12	28"	3"	4*	F, M, IC	49"	14 1/4"	11/2"	13/4"	6 3/4	939.99
SX4 FIELD COMPACT											
511211390	12	24"	3"	4*	F, M, IC	43 3/4"	13"	11/2"	13/4"	6 3/8	\$939.99
511211391	12	26"	3"	4*	F, M, IC	45 3/4"	13"	11/2"	13/4"	6 1/2	939.99
511211392	12	28"	3"	4*	F, M, IC	47 3/4"	13"	11/2"	13/4"	6 5/8	939.99

*TOTAL AMMUNITION CAPACITY INCLUDES ONE ADDITIONAL SHELL IN THE CHAMBER.

SUPER X³

GET RELENTLESS RELIABILITY AND OUTSTANDING CYCLING SPEED.

It takes an awesome autoloading shotgun to put 12 shells down range in a mere 1.442 seconds. But speed doesn't mean much without absolute reliability. That's when the Super X³ lets you show the world what you can do with a shotgun at your shoulder. From now on, no fast-passing clay or sudden flushing bird can escape your blast.

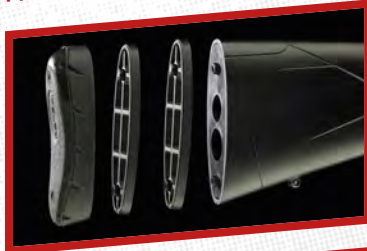

There is no reason to put up with a shotgun that does not fit you, because proper stock fit is critical to comfortable and accurate shooting. Most Super X³ shotguns come with **LENGTH OF PULL SPACERS** that fit between the stock and the recoil pad, allowing easy adjustments to length of pull. When the length of pull is adjusted properly, you smoothly shoulder the gun with confidence and the "felt recoil" you experience is greatly diminished. Adjustments range from 13" to 13 1/2" on the compact models and from 14 1/4" to 14 3/4" on the full size models.



Getting pounded by recoil is a thing of the past with the **INFLEX TECHNOLOGY RECOIL PAD**. Specially shaped rib structures located inside the pad help direct and channel the recoil impulse, moving the comb down and away from your cheek to reduce felt recoil to very manageable levels, even when shooting heavy magnum loads. A hard heel insert on the pad makes mounting the Super X³ snag-free.

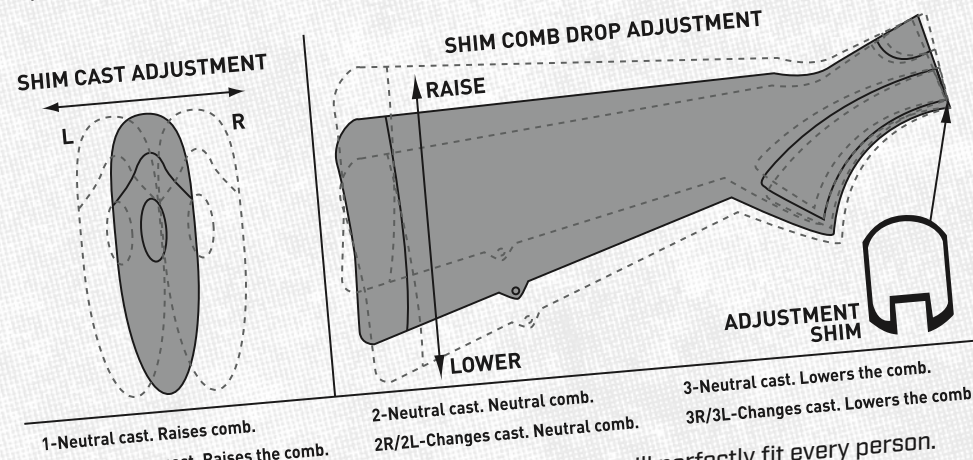

Every shooter is different, and no single stock design will perfectly fit every person. **MULTI-AXIS CAST/DROP SHIMS** on Super X³ synthetic stock models allow you to easily adjust both cast on/cast off and drop at comb over a 1/4" range simply by inserting one of the six special shims between the receiver and the buttstock.



The **AMBIDEXTRIOUS SAFETY** button on the Super X³ is located at the rear of the trigger guard and is easily reversible for both right- or left-handed shooters.



The **DROP-OUT TRIGGER GROUP** is easy to remove for cleaning and lubrication.

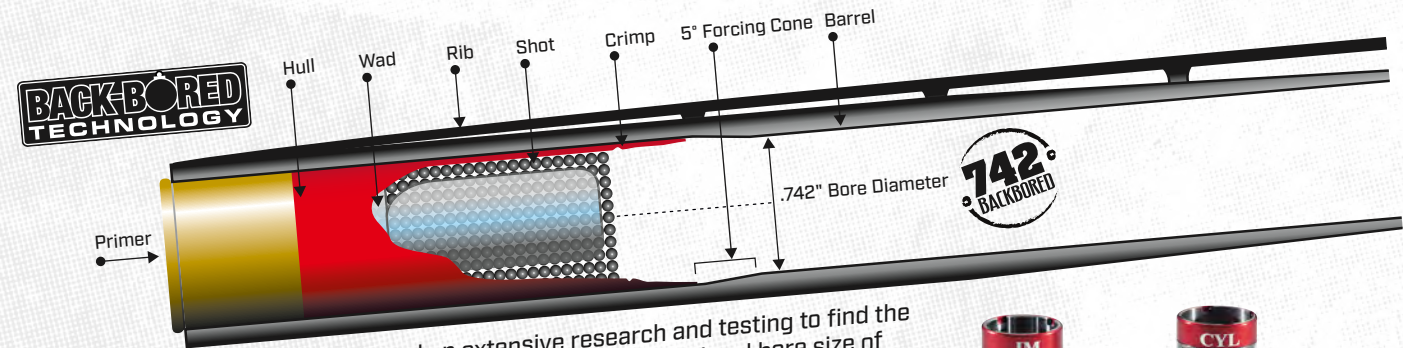

BACK-BORED TECHNOLOGY is based on extensive research and testing to find the secret to tighter, more consistent patterns. Instead of the traditional bore size of .729", this research shows the ideal 12 gauge interior diameter is .742". In 20 gauge barrels the ideal bore diameter is .630" instead of the standard .618". If the bore is any larger the gases will blow by the shot cup and reduce pellet velocity. If the bore is too tight the pellets are deformed as they pass through the forcing cone, causing poor ballistic performance.



CHROME-PLATED CHAMBER AND BORE are critical for today's steel or Hi-Density (HD) shot. Hard chrome makes the surfaces highly resistant to wear and gives you superior protection from rust and corrosion. That's why all smoothbore Super X³ shotguns feature a hard-chromed chamber and bore.



LOAD DIVERSITY means a Super X³ can reliably shoot them all, from light factory field shells to heavy magnum waterfowl and turkey loads. That's why the Super X³ has been proven as the most versatile autoloader on the range, in the marsh and in the field.



From the duck blind to the firing line, the **VECTOR-PLUS CHOKE TUBE SYSTEM** is the world's most consistent. The Super X³ comes with full, modified and improved cylinder flush-mounted choke tubes so your gun is ready for anything, right out of the box. Additional choke tubes are available at your local firearms dealer.

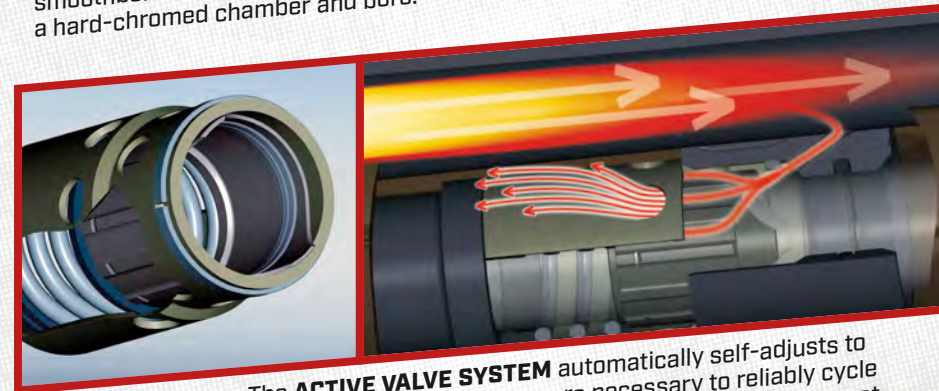

The **ACTIVE VALVE SYSTEM** automatically self-adjusts to allocate the exact gas pressure necessary to reliably cycle a wide range of loads commonly used for hunting or target shooting. When firing the heaviest magnum loads in 3 1/2" shooting, gases vent upward and a portion of them are vented forward out the Quadra-Vent™ ports in the forearm to help regulate bolt speed. Both 3" and 3 1/2" Super X³ shotguns will reliably cycle even 1 1/8 oz., 2 3/4" light loads.



Excess gases from heavy loads are channeled through the forward **QUADRA-VENT™** ports for cleaner and more reliable operation.

SMOKIN' HOT.

TURN EVERY CLAY INTO A PUFF OF SMOKE.



ULTIMATE SPORTING ADJUSTABLE

- SATIN OIL FINISH GRADE II/III WALNUT STOCK WITH ADJUSTABLE COMB AND CUT CHECKERING looks elegant and provides the ultimate in functionality
- MATTE NICKEL-PLATED RECEIVER is a strong, lightweight aluminum alloy that reduces weight for a fast, easy swing
- SIGNATURE RED BRILEY[®] bolt handle, bolt release button and magazine cap weight system for a custom look and feel
- BACK-BORED TECHNOLOGY provides optimum shot patterns that are dense and even
- PERMA-COTE GRAY FINISH PORTED BARREL WITH VENT RIB, TRUGLO[®] FIBER-OPTIC SIGHT AND WHITE MID-BEAD give you a clean sighting plane

- HARD CHROME-PLATED CHAMBER AND BORE make these surfaces highly resistant to wear and corrosion
- EXTENDED SIGNATURE INVECTOR-PLUS CHOKE TUBES offer consistent, reliable patterns
- ACTIVE VALVE SYSTEM cycles a wide variety of loads while reducing "felt recoil"
- PACHMAYR[®] DECELERATOR[®] RECOIL PAD provides optimal protection against felt recoil
- AMBIDEXTROUS CROSSBOLT SAFETY is easily reversible
- DROP-OUT TRIGGER GROUP allows for easy cleaning
- RED ABS HARD-SIDE CASE is included



COMPOSITE SPORTING CARBON FIBER

- SYNTHETIC STOCK WITH CARBON FIBER FINISH provides excellent grip with a modern aerospace look
- MATTE NICKEL-PLATED RECEIVER is a strong, lightweight aluminum alloy that reduces weight for a fast, easy swing
- SIGNATURE RED BRILEY[®] bolt handle, bolt release button and magazine cap weight system for a custom look and feel
- BACK-BORED TECHNOLOGY provides optimum shot patterns that are dense and even
- PERMA-COTE GRAY FINISH PORTED BARREL WITH VENT RIB, TRUGLO[®] FIBER-OPTIC SIGHT AND WHITE MID-BEAD give you a clean sighting plane
- HARD CHROME-PLATED CHAMBER AND BORE make these surfaces highly resistant to wear and corrosion

- EXTENDED SIGNATURE INVECTOR-PLUS CHOKE TUBES offer consistent, reliable patterns
- ACTIVE VALVE SYSTEM cycles a wide variety of loads while reducing "felt recoil"
- CAST/DROP SHIMS AND LENGTH OF PULL SPACERS allow adjustments for a perfect fit
- INFLEX TECHNOLOGY RECOIL PAD directs felt recoil down and away from your cheek to reduce flinch and fatigue
- AMBIDEXTROUS CROSSBOLT SAFETY is easily reversible
- DROP-OUT TRIGGER GROUP WITH CARBON FIBER FINISH allows for easy cleaning
- RED ABS HARD-SIDE CASE is included



COMPOSITE SPORTING

- SYNTHETIC STOCK provides excellent grip
- MATTE NICKEL-PLATED RECEIVER is a strong, lightweight aluminum alloy that reduces weight for a fast, easy swing
- SIGNATURE RED BRILEY[®] bolt handle, bolt release button and magazine cap weight system for a custom look and feel
- BACK-BORED TECHNOLOGY provides optimum shot patterns that are dense and even
- PERMA-COTE GRAY FINISH PORTED BARREL WITH VENT RIB, TRUGLO[®] FIBER-OPTIC SIGHT AND WHITE MID-BEAD give you a clean sighting plane
- HARD CHROME-PLATED CHAMBER AND BORE make these surfaces highly resistant to wear and corrosion

- EXTENDED SIGNATURE INVECTOR-PLUS CHOKE TUBES offer consistent, reliable patterns
- ACTIVE VALVE SYSTEM cycles a wide variety of loads while reducing "felt recoil"
- CAST/DROP SHIMS AND LENGTH OF PULL SPACERS allow adjustments for a perfect fit
- INFLEX TECHNOLOGY RECOIL PAD directs felt recoil down and away from your cheek to reduce flinch and fatigue
- AMBIDEXTROUS CROSSBOLT SAFETY is easily reversible
- DROP-OUT TRIGGER GROUP allows for easy cleaning
- RED ABS HARD-SIDE CASE is included

ITEM NUMBER	GAUGE	BARREL LENGTH	CHAMBER	MAGAZINE CAPACITY	CHOKE TUBES INCLUDED	OVERALL LENGTH**	LENGTH OF PULL	DROP AT COMB	DROP AT HEEL	NOMINAL WT. (LBS.)	SUGGESTED RETAIL
SX3 ULTIMATE SPORTING ADJUSTABLE											
511174392	12	28"	2 3/4"	4*	LF, IM, M, IC, SK	49 1/4"	14 1/2"	11/2"	13/4"	7 3/8	\$1,869.99
511174393	12	30"	2 3/4"	4*	LF, IM, M, IC, SK	51 1/4"	14 1/2"	11/2"	13/4"	7 1/2	1,869.99
511174394	12	32"	2 3/4"	4*	LF, IM, M, IC, SK	53 1/4"	14 1/2"	11/2"	13/4"	7 5/8	1,869.99
SX3 COMPOSITE SPORTING CARBON FIBER											
511172392	12	28"	2 3/4"	4*	LF, IM, M, IC, SK	49"	14 1/4"	13/4"	2"	7 1/4	\$1,739.99
511172393	12	30"	2 3/4"	4*	LF, IM, M, IC, SK	51"	14 1/4"	13/4"	2"	7 3/8	1,739.99
511172394	12	32"	2 3/4"	4*	LF, IM, M, IC, SK	53"	14 1/4"	13/4"	2"	7 1/2	1,739.99
SX3 COMPOSITE SPORTING											
511173392	12	28"	2 3/4"	4*	LF, IM, M, IC, SK	49"	14 1/4"	13/4"	2"	7 1/4	\$1,679.99
511173393	12	30"	2 3/4"	4*	LF, IM, M, IC, SK	51"	14 1/4"	13/4"	2"	7 3/8	1,679.99
511173394	12	32"	2 3/4"	4*	LF, IM, M, IC, SK	53"	14 1/4"	13/4"	2"	7 1/2	1,679.99

*TOTAL AMMUNITION CAPACITY INCLUDES ONE ADDITIONAL SHELL IN THE CHAMBER.
**OVERALL LENGTH DOES NOT INCLUDE CHOKE TUBE.

BUSTED BIRDS.

TWO HIGH-SPEED SHOTGUNS THAT WILL TAKE YOUR BAG TO THE LIMIT IN NO TIME.



FIELD



- **SATIN OIL FINISH WALNUT STOCK WITH CLASSIC CUT CHECKERING** improves grip and looks elegant
- **MATTE BLACK RECEIVER** is strong, lightweight aluminum alloy to reduce weight for easy carrying
- **BACK-BORED TECHNOLOGY** provides optimum shot patterns that are dense and even
- **VENT RIB** gives you a smooth, clean sighting plane and helps reduce weight
- **BRASS FRONT SIGHT BEAD** offers a fast, natural sight picture in a wide variety of lighting conditions

- **HARD CHROME-PLATED CHAMBER AND BORE** make these surfaces highly resistant to wear and corrosion
- **INVECTOR-PLUS CHOKE TUBES** offer consistent, reliable patterns
- **ACTIVE VALVE SYSTEM** cycles a wide variety of loads while reducing "felt recoil"
- **PACHMAYR® DECELERATOR® RECOIL PAD** provides optimal protection against felt recoil
- **AMBIDEXTROUS CROSSBOLT SAFETY** is easily reversible
- **DROP-OUT TRIGGER GROUP** allows for easy cleaning



FIELD COMPACT



- **COMPACT 13" LENGTH OF PULL** to fit smaller statured shooters
- **SATIN OIL FINISH WALNUT STOCK WITH CLASSIC CUT CHECKERING** improves grip and looks elegant
- **MATTE BLACK RECEIVER** is strong, lightweight aluminum alloy to reduce weight for easy carrying
- **BACK-BORED TECHNOLOGY** provides optimum shot patterns that are dense and even
- **VENT RIB** gives you a smooth, clean sighting plane and helps reduce weight
- **BRASS FRONT SIGHT BEAD** offers a fast, natural sight picture in a wide variety of lighting conditions

- **HARD CHROME-PLATED CHAMBER AND BORE** make these surfaces highly resistant to wear and corrosion
- **INVECTOR-PLUS CHOKE TUBES** offer consistent, reliable patterns
- **ACTIVE VALVE SYSTEM** cycles a wide variety of loads while reducing "felt recoil"
- **PACHMAYR® DECELERATOR® RECOIL PAD** provides optimal protection against felt recoil
- **AMBIDEXTROUS CROSSBOLT SAFETY** is easily reversible
- **DROP-OUT TRIGGER GROUP** allows for easy cleaning



ITEM NUMBER	GAUGE	BARREL LENGTH	CHAMBER	MAGAZINE CAPACITY	CHOKE TUBES INCLUDED	OVERALL LENGTH	LENGTH OF PULL	DROP AT COMB	DROP AT HEEL	NOMINAL WT. (LBS.)	SUGGESTED RETAIL
SX3 FIELD											
511144691	20	26"	3"	4*	F, M, IC	47"	14 1/4"	13/8"	17/8"	6 3/8	\$1,139.99
511144692	20	28"	3"	4*	F, M, IC	49"	14 1/4"	13/8"	17/8"	6 1/2	1,139.99
SX3 FIELD COMPACT											
511146690	20	24"	3"	4*	F, M, IC	43 3/4"	13"	15/8"	17/8"	6 1/4	\$1,139.99
511146691	20	26"	3"	4*	F, M, IC	45 3/4"	13"	15/8"	17/8"	6 3/8	1,139.99
511146692	20	28"	3"	4*	F, M, IC	47 3/4"	13"	15/8"	17/8"	6 1/2	1,139.99

*TOTAL AMMUNITION CAPACITY INCLUDES ONE ADDITIONAL SHELL IN THE CHAMBER.

NAME GAME.

BUCKS, BOARS OR BIRDS. NAME YOUR GAME AND THESE SHOTGUNS WILL DELIVER.



BLACK SHADOW



- **SYNTHETIC STOCK WITH TEXTURED GRIPPING SURFACES** gives your hands a sure, non-slip grip and the non-glare matte black finish won't spook wary game
- **BACK-BORED TECHNOLOGY** provides optimum shot patterns that are dense and even
- **INVECTOR-PLUS CHOKE TUBE SYSTEM** offers consistent patterns to match your situation
- **HARD CHROME-PLATED CHAMBER AND BORE** make these surfaces highly resistant to wear and corrosion
- **BRASS BEAD FRONT SIGHT** offers a fast, natural sight picture

- **SELF-ADJUSTING ACTIVE VALVE SYSTEM** cycles a wide variety of loads while reducing "felt recoil"
- **QUADRA-VENT™ PORTS** vent excess gases for cleaner operation
- **DROP-OUT TRIGGER GROUP** allows for easy cleaning
- **AMBIDEXTROUS CROSSBOLT SAFETY** is easily reversible
- **CAST/DROP SHIMS AND LENGTH OF PULL SPACERS** allow adjustments for a perfect fit
- **INFLEX TECHNOLOGY RECOIL PAD** directs felt recoil down and away from your cheek to reduce flinch and fatigue



CANTILEVER BUCK



- **SYNTHETIC STOCK WITH TEXTURED GRIPPING SURFACES** gives your hands a sure, non-slip grip and the non-glare matte black finish won't spook wary deer
- **RIFLED 22" BARREL** optimized for extreme accuracy with 2 3/4" and 3" sabots and slugs
- **MATTE BLACK RECEIVER** is strong, lightweight aluminum alloy for easy carrying
- **WEAVER-STYLE CANTILEVER RAIL DESIGN** makes it easy to attach an electronic sight or conventional scope

- **TRUGLO® FIBER-OPTIC FRONT SIGHT** with adjustable rear sight gathers light for fast, quick pointing
- **SELF-ADJUSTING ACTIVE VALVE SYSTEM** cycles a wide variety of loads while reducing "felt recoil"
- **DROP-OUT TRIGGER GROUP** allows for easy cleaning
- **AMBIDEXTROUS CROSSBOLT SAFETY** is easily reversible
- **CAST/DROP SHIMS AND LENGTH OF PULL SPACERS** allow adjustments for a perfect fit
- **INFLEX TECHNOLOGY RECOIL PAD** directs felt recoil down and away from your cheek to reduce flinch and fatigue



WATERFOWL HUNTER



- **SYNTHETIC STOCK WITH TEXTURED GRIPPING SURFACES** gives your hands a sure, non-slip grip and the non-glare Mossy Oak Shadow Grass Blades camo finish won't spook wary waterfowl
- **BACK-BORED TECHNOLOGY** provides optimum shot patterns that are dense and even
- **INVECTOR-PLUS CHOKE TUBE SYSTEM** offers consistent patterns to match your situation
- **HARD CHROME-PLATED CHAMBER AND BORE** make these surfaces highly resistant to corrosion and wear from steel shot
- **VENT RIB** gives you a smooth, clean sighting plane
- **TRUGLO® LONG BEAD™ FIBER-OPTIC FRONT SIGHT** offers a true, precise sight picture

- **SELF-ADJUSTING ACTIVE VALVE GAS SYSTEM** cycles a wide variety of loads while reducing "felt recoil"
- **QUADRA-VENT™ PORTS** vent excess gases for cleaner operation
- **DROP-OUT TRIGGER GROUP** allows for easy cleaning
- **AMBIDEXTROUS CROSSBOLT SAFETY** is easily reversible
- **CAST/DROP SHIMS AND LENGTH OF PULL SPACERS** allow adjustments for a perfect fit
- **INFLEX TECHNOLOGY RECOIL PAD** directs felt recoil down and away from your cheek to reduce flinch and fatigue

ITEM NUMBER	GAUGE	BARREL LENGTH	CHAMBER	MAGAZINE CAPACITY	CHOKE TUBES INCLUDED	OVERALL LENGTH	LENGTH OF PULL	DROP AT COMB	DROP AT HEEL	NOMINAL WT. (LBS.)	SUGGESTED RETAIL
SX3 BLACK SHADOW											
511123690	20	24"	3"	4*	F, M, IC	45"	14 1/4"	13/4"	2"	6 1/2	\$1,069.99
511123691	20	26"	3"	4*	F, M, IC	47"	14 1/4"	13/4"	2"	6 5/8	1,069.99
511123692	20	28"	3"	4*	F, M, IC	49"	14 1/4"	13/4"	2"	6 3/4	1,069.99
SX3 CANTILEVER BUCK											
511147640	20	22"	3"	4**	1:24" RH Twist	43"	14 1/4"	13/4"	2"	7 1/2	\$1,199.99
SX3 WATERFOWL HUNTER											
511155691	20	26"	3"	4*	F, M, IC	47"	14 1/4"	13/4"	2"	6 5/8	\$1,199.99
511155692	20	28"	3"	4*	F, M, IC	49"	14 1/4"	13/4"	2"	6 3/4	1,199.99

*TOTAL AMMUNITION CAPACITY INCLUDES ONE ADDITIONAL SHELL IN THE CHAMBER.
 **MAGAZINE CAPACITY DEPENDS ON SHELL LENGTH. SOME SLUGS ARE LONGER THAN STANDARD 2 3/4" SHOT SHELLS.

TWO FOR TOMS.

IF YOU WANT THE ULTIMATE TURKEY GUN, TAKE A LOOK AT THESE TWO BEAUTIES.



"THE SUPER X³ LONG BEARD[™] IS THE SWEETEST SHOOTING TURKEY GUN I'VE EVER OWNED! I'VE PUT IT THROUGH EVERY TEST IN EVERY CONDITION A TURKEY HUNTER CAN DREAM OF, AND IT ALWAYS PERFORMS!"
 — Mark Drury • Drury Outdoors



LONG BEARD[™] XR[®] IS LETHAL AT LONGER RANGES.
 If you think 40 yards is as far as you can take a trophy tom, think again. With Winchester[™] Long Beard[™] XR[®] and its Shot-Lok[™] Technology, your effective range can increase by 20 to 30 yards and still deliver devastating, one-shot, one-turkey performance.



EXTRA-FULL TURKEY CHOKE TUBE
 A tight, dense pattern of heavy shot is critical for taking turkeys. You get an Invector-Plus Extra-Full Turkey choke tube standard with the Super X³ NWTf[®] Cantilever Turkey shotgun. The knurled friction band makes it easy to install and remove and the camo front band won't give you away to a sharp-eyed tom.



NWTf[®] CANTILEVER TURKEY



- **SYNTHETIC STOCK WITH TEXTURED GRIPPING SURFACES** gives your hands a sure, non-slip grip and the non-glare Mossy Oak[™] Break-Up Country[™] camo finish won't be seen by turkeys
- **BACK-BORED TECHNOLOGY** provides optimum shot patterns that are dense and even
- **INVECTOR-PLUS EXTRA-FULL TURKEY EXTENDED CHOKE TUBE** with Mossy Oak[™] Break-Up Country[™] camo front band produces a tight, tom-busting pattern
- **24" BARREL** is easy to swing in tight brush
- **HARD CHROME-PLATED CHAMBER AND BORE** make these surfaces highly resistant to wear and corrosion

- **TRUGLO[®] FIBER-OPTIC FRONT SIGHT WITH ADJUSTABLE REAR SIGHT** gathers light for quick target acquisition
- **WEAVER[™]-STYLE CANTILEVER RAIL DESIGN** makes it easy to attach an electronic sight or conventional scope
- **QUADRA-VENT[™] PORTS** vent excess gases for cleaner operation
- **DROP-OUT TRIGGER GROUP** allows for easy cleaning
- **AMBIDEXTROUS CROSSBOLT SAFETY** is easily reversible
- **CAST/DROP SHIMS AND LENGTH OF PULL SPACERS** allow adjustments for a perfect fit
- **INFLEX TECHNOLOGY RECOIL PAD** directs felt recoil down and away from your cheek to reduce flinch and fatigue



LONG BEARD[™] CHOKE TUBE
 Aggressively avid turkey hunters will go to great lengths to tag that trophy tom. The Winchester Super X³ Long Beard[™] model features an extended Extra-Full Turkey tube with a fluted body, knurled friction ring and camo front band. It's designed to extract every bit of potential from Winchester's Long Beard[™] XR[®] turkey ammunition.



LONG BEARD[™]



- **SYNTHETIC PISTOL GRIP STOCK WITH TEXTURED GRIPPING SURFACES** gives your hands a sure, non-slip grip and the non-glare Mossy Oak[™] Break-Up Country[™] finish helps hide you from trophy turkeys
- **THREE INTERCHANGEABLE COMB INSERTS AND THREE RECOIL PAD OPTIONS** let you fine tune the shotgun's fit to match your shooting style
- **BACK-BORED TECHNOLOGY** provides optimum shot patterns that are dense and even
- **INVECTOR-PLUS BRILEY[®] EXTRA-FULL LONG BEARD[™] EXTENDED CHOKE TUBE** is optimized for Winchester[™] Long Beard[™] XR[®] ammunition to produce a tight, tom-busting pattern

- **24" BARREL** is easy to swing in tight brush
- **HARD CHROME-PLATED CHAMBER AND BORE** make these surfaces highly resistant to wear and corrosion
- **TRUGLO[®] FIBER-OPTIC FRONT SIGHT WITH ADJUSTABLE REAR SIGHT** gathers light for quick target acquisition
- **WEAVER[™]-STYLE CANTILEVER RAIL DESIGN** makes it easy to attach an electronic sight or conventional scope
- **QUADRA-VENT[™] PORTS** vent excess gases for cleaner operation
- **DROP-OUT TRIGGER GROUP** allows for easy cleaning
- **AMBIDEXTROUS CROSSBOLT SAFETY** is easily reversible

ITEM NUMBER	GAUGE	BARREL LENGTH	CHAMBER	MAGAZINE CAPACITY	CHOKE TUBES INCLUDED	OVERALL LENGTH**	LENGTH OF PULL	DROP AT COMB	DROP AT HEEL	NOMINAL WT. (LBS.)	SUGGESTED RETAIL
SX3 NWTf CANTILEVER TURKEY											
511169690	20	24"	3"	4*	X-FULL TURKEY	45"	14 1/4"	1 3/4"	2"	7 1/8	\$1,199.99
SX3 LONG BEARD											
511168290	12	24"	3 1/2"	4*	LONG BEARD	45"	14 1/4"	1 3/4"	2"	7 1/2	\$1,269.99
511168690	20	24"	3"	4*	LONG BEARD	45"	14 1/4"	1 3/4"	2"	7 3/8	1,269.99

*TOTAL AMMUNITION CAPACITY INCLUDES ONE ADDITIONAL SHELL IN THE CHAMBER. **OVERALL LENGTH DOES NOT INCLUDE CHOKE TUBE.

SUPER X[®] PUMP

EXPLORE THE FEATURES THAT MAKE IT THE FASTEST PUMP ON THE PLANET.

Shuck a shell into a Winchester Super X[®] Pump shotgun and what you hear is the sound of quality. What you feel is the silky smoothness that comes from the Super X Pump shotgun's inertia-assisted action. It's a unique action design that cycles so fast you'll think you're shooting an autoloader. And that's something that gives you added confidence in every situation.

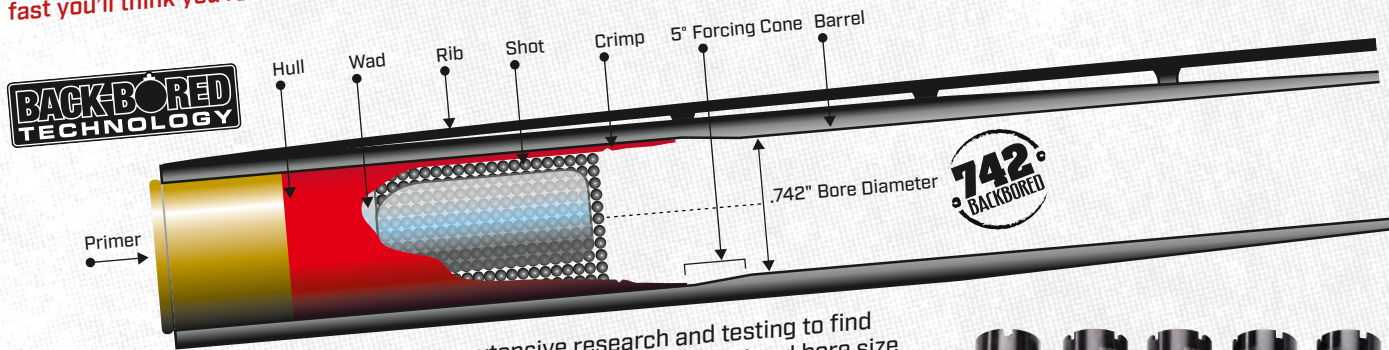

BACK-BORED TECHNOLOGY is based on extensive research and testing to find the secret to tighter, more consistent patterns. Instead of the traditional bore size of .729", this research shows the ideal 12 gauge interior diameter is .742". In 20 gauge barrels the ideal bore diameter is .630" instead of the standard .618". If the bore is any larger the gases will blow by the shot cup and reduce pellet velocity. If the bore is too tight the pellets are deformed as they pass through the forcing cone, causing poor ballistic performance.

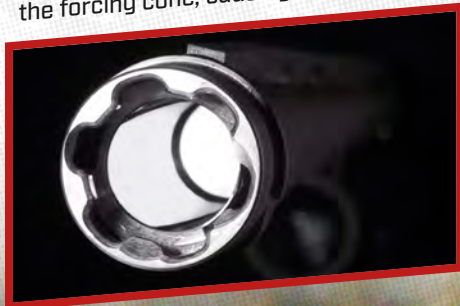

CHROME-PLATED CHAMBER AND BORE are critical for today's steel and Hi-Density (HD) shot. Hard chrome makes the surfaces highly resistant to wear and gives you superior protection from rust and corrosion. That's why all smoothbore Super X[®] Pump shotguns feature a hard-chromed chamber and bore.



From the duck blind to the firing line, the **INVECTOR-PLUS CHOKE TUBE SYSTEM** is the world's most consistent. The Super X[®] Pump comes with full, modified and improved cylinder flush-mounted choke tubes so your gun is ready for anything, right out of the box. Additional choke tubes are available at your local firearms dealer.



SPEED-PLUG SYSTEM lets you remove the three-shot adaptor with your fingers. Just remove the magazine cap, push on the spring retainer holding the spring in place, twist and remove the adaptor. It's a trouble-free design that lets you "pull the plug" in mere seconds without any tools.



DROP-OUT TRIGGER GROUP lets you remove one pin and pull the complete trigger system out for cleaning, lubrication and inspection. It's an easy way to keep your Super X[®] Pump shotgun in top shape, regardless of nasty weather or gritty shooting conditions.



The Super X[®] Pump has the best recoil pad ever put on a shotgun. Directional rib structures inside the **INFLEX TECHNOLOGY RECOIL PAD** help channel the recoil impulse by moving the comb down and away from your cheek. The pad's smooth textured surface makes shouldering the Super X Pump snag free regardless of what clothing you're wearing.

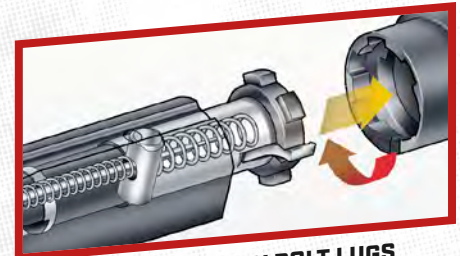

Four massive **ROTARY BOLT LUGS** provide support, strength and solid lockup in the barrel of the lightning-fast Super X[®] Pump. Under recoil, the mass of your body slows the rearward travel of the shotgun, while the inertial motion of the bolt, slide and forearm continue cycling the action to give you a head start ejecting the fired shell. Robust dual steel action guide bars eliminate the twisting and binding that waste time and energy when cycling the action.



The **CROSSBOLT SAFETY** button on the Super X[®] Pump is located on the front of the trigger guard for easy access, even when you're wearing heavy waterfowling gloves.

BLACK CHROME FINISH on the bolt, barrel, slide, action bars and other parts protects better than conventional bluing and stands up to years of wear and harsh conditions.



DURABLE E-COATING on the magazine tube helps protect it from wear and corrosion to keep it looking sharp for years to come.

TRAP MASTER.

SHATTER EVERY CLAY WITH THE CONFIDENCE THAT COMES FROM SHOOTING A WINCHESTER[®] PUMP.



TRAP



- **SATIN FINISHED STOCK WITH A HIGH PROFILE TRAP COMB** and forearm with traditional checkering provides a sure grip when the trapshooting action gets fast and furious
- **BACK-BORED TECHNOLOGY** provides optimum shot patterns, even from the 27 yard line
- **INVECTOR-PLUS CHOKE TUBE SYSTEM** offers consistent patterns to match your shooting situation
- **HARD CHROME-PLATED CHAMBER AND BORE** make surfaces highly resistant to wear and corrosion from thousands of shells
- **BLACK CHROME PROTECTION** on the bolt and other components lasts longer than traditional bluing

- **5/16" TRAP RIB WITH TRUGLO[®] FIBER-OPTIC FRONT SIGHT AND AN IVORY MID-BEAD** produce a crisp sight picture on both rising and crossing targets
- **3-SHOT ADAPTOR WITH SPEED-PLUG SYSTEM** is easily removed without tools
- **DROP-OUT TRIGGER GROUP** allows for easy cleaning
- **CROSSBOLT SAFETY** is easily operated
- **INFLEX TECHNOLOGY RECOIL PAD** directs felt recoil down and away from your cheek to help reduce flinch and fatigue, especially important when you're going for 100 straight targets



TRAP COMPACT



- **SATIN FINISHED STOCK WITH A HIGH PROFILE TRAP COMB** and forearm with traditional checkering provides a sure grip when the trapshooting action gets fast and furious
- **COMPACT 13" LENGTH OF PULL BUTTSTOCK** makes it an ideal shotgun for younger shooters or those of smaller stature
- **BACK-BORED TECHNOLOGY** provides optimum shot patterns, even from the 27 yard line
- **INVECTOR-PLUS CHOKE TUBE SYSTEM** offers consistent patterns to match your shooting situation
- **HARD CHROME-PLATED CHAMBER AND BORE** make surfaces highly resistant to wear and corrosion from thousands of shells
- **BLACK CHROME PROTECTION** on the bolt and other components lasts longer than traditional bluing

- **5/16" TRAP RIB WITH TRUGLO[®] FIBER-OPTIC FRONT SIGHT AND AN IVORY MID-BEAD** produce a crisp sight picture on both rising and crossing targets
- **3-SHOT ADAPTOR WITH SPEED-PLUG SYSTEM** is easily removed without tools
- **DROP-OUT TRIGGER GROUP** allows for easy cleaning
- **CROSSBOLT SAFETY** is easily operated
- **INFLEX TECHNOLOGY RECOIL PAD** directs felt recoil down and away from your cheek to help reduce flinch and fatigue, especially important when you're going for 100 straight targets

ITEM NUMBER	GAUGE	BARREL LENGTH	CHAMBER	MAGAZINE CAPACITY	CHOKE TUBES INCLUDED	OVERALL LENGTH	LENGTH OF PULL	DROP AT COMB	DROP AT HEEL	NOMINAL WT. (LBS.)	SUGGESTED RETAIL
SXP TRAP											
512296393	12	30"	3"	4*	F, IM, M	51"	14 1/4"	13/8"	2 1/8"	7 1/2	\$479.99
512296394	12	32"	3"	4*	F, IM, M	53"	14 1/4"	13/8"	2 1/8"	7 5/8	479.99
SXP TRAP COMPACT											
512297392	12	28"	3"	4*	F, IM, M	47 3/4"	13"	13/8"	2 1/8"	7 1/4	\$479.99
512297393	12	30"	3"	4*	F, IM, M	49 3/4"	13"	13/8"	2 1/8"	7 3/8	479.99

*TOTAL AMMUNITION CAPACITY INCLUDES ONE ADDITIONAL SHELL IN THE CHAMBER.

FULL SPEED AHEAD.

WITH A SUPER X[®] PUMP AT YOUR SHOULDER THERE'S NO BIRD THAT FLIES TOO FAST.



FIELD



- **SATIN FINISHED STOCK AND FOREARM** with traditional checkering provides a sure grip when the hunting action gets hot
- **BACK-BORED TECHNOLOGY** provides optimum shot patterns that are dense and even
- **3" CHAMBER** gives you the added range to knock down game with heavy hunting loads
- **INVECTOR-PLUS CHOKE TUBE SYSTEM** offers consistent patterns to match your game and situation
- **HARD CHROME-PLATED CHAMBER AND BORE** make surfaces highly resistant to wear and corrosion

- **BLACK CHROME PROTECTION** on the bolt and other components lasts longer than traditional bluing
- **BRASS FRONT SIGHT BEAD** offers a fast, natural sight picture
- **3-SHOT ADAPTOR WITH SPEED-PLUG SYSTEM** is easily removed without tools
- **DROP-OUT TRIGGER GROUP** allows for easy cleaning
- **CROSSBOLT SAFETY** is easily operated
- **INFLEX TECHNOLOGY RECOIL PAD** directs felt recoil down and away from your cheek to reduce flinch and fatigue

FIELD COMPACT



- **COMPACT 13" LENGTH OF PULL** to better fit smaller statured shooters
- **SATIN FINISHED STOCK AND FOREARM** with traditional checkering provides a sure grip when the hunting action gets hot
- **BACK-BORED TECHNOLOGY** provides optimum shot patterns that are dense and even
- **3" CHAMBER** gives you the added range to knock down game with heavy hunting loads
- **INVECTOR-PLUS CHOKE TUBE SYSTEM** offers consistent patterns to match your game and situation

- **HARD CHROME-PLATED CHAMBER AND BORE** make surfaces highly resistant to wear and corrosion
- **BLACK CHROME PROTECTION** on the bolt and other components lasts longer than traditional bluing
- **BRASS FRONT SIGHT BEAD** offers a fast, natural sight picture
- **3-SHOT ADAPTOR WITH SPEED-PLUG SYSTEM** is easily removed without tools
- **DROP-OUT TRIGGER GROUP** allows for easy cleaning
- **CROSSBOLT SAFETY** is easily operated
- **INFLEX TECHNOLOGY RECOIL PAD** directs felt recoil down and away from your cheek to reduce flinch and fatigue

ITEM NUMBER	GAUGE	BARREL LENGTH	CHAMBER	MAGAZINE CAPACITY	CHOKE TUBES INCLUDED	OVERALL LENGTH	LENGTH OF PULL	DROP AT COMB	DROP AT HEEL	NOMINAL WT. (LBS.)	SUGGESTED RETAIL
SXP FIELD											
512266391	12	26"	3"	4*	F, M, IC	46 3/4"	14"	1 5/8"	2"	7	\$399.99
512266392	12	28"	3"	4*	F, M, IC	48 3/4"	14"	1 5/8"	2"	7 1/8	399.99
512266691	20	26"	3"	5*	F, M, IC	46 3/4"	14"	1 5/8"	2"	6 3/4	429.99
512266692	20	28"	3"	5*	F, M, IC	48 3/4"	14"	1 5/8"	2"	6 7/8	429.99
SXP FIELD COMPACT											
512287390	12	24"	3"	4*	F, M, IC	43 1/2"	13"	1 5/8"	2"	6 1/2	\$399.99
512271391	12	26"	3"	4*	F, M, IC	45 1/2"	13"	1 5/8"	2"	6 5/8	399.99
512271392	12	28"	3"	4*	F, M, IC	47 1/2"	13"	1 5/8"	2"	6 3/4	399.99
512271690	20	24"	3"	5*	F, M, IC	43 1/2"	13"	1 5/8"	2"	6 1/2	429.99
512271691	20	26"	3"	5*	F, M, IC	45 1/2"	13"	1 5/8"	2"	6 1/2	429.99
512271692	20	28"	3"	5*	F, M, IC	47 1/2"	13"	1 5/8"	2"	6 5/8	429.99

*TOTAL AMMUNITION CAPACITY INCLUDES ONE ADDITIONAL SHELL IN THE CHAMBER.

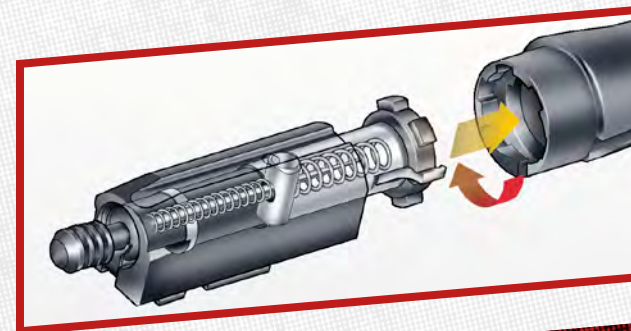

Four massive **ROTARY BOLT LUGS** provide support, strength and solid lockup in the barrel of the lightning-fast Super X[®] Pump shotgun. Under recoil, the mass of your body slows the rearward travel of the shotgun, while the inertial motion of the bolt, slide and forearm continue cycling the action to give you a head start ejecting the fired shell. Robust dual steel action guide bars eliminate the twisting and binding that waste time and energy when cycling the action.

HUNT 'EM ALL.

MADE TO HELP YOU HUNT ANY BIRDS, ANYWHERE, IN ANY SEASON.



WATERFOWL HUNTER



- **BLACK CHROME PROTECTION** on the bolt and other components lasts longer than traditional bluing
- **TRUGLO[®] LONG BEAD[™] FIBER-OPTIC FRONT SIGHT** offers a true, precise sight picture
- **3-SHOT ADAPTOR WITH SPEED-PLUG SYSTEM** is easily removed without tools
- **ROTARY BOLT** with four massive lugs provides strength, support and solid lockup
- **DROP-OUT TRIGGER GROUP** allows for easy cleaning
- **CROSSBOLT SAFETY** is easily operated, even with gloves
- **INFLEX TECHNOLOGY RECOIL PAD** directs "felt recoil" down and away from your cheek to reduce flinch and fatigue



UNIVERSAL HUNTER



- **BLACK CHROME PROTECTION** on the bolt and other components lasts longer than traditional bluing
- **TRUGLO[®] LONG BEAD[™] FIBER-OPTIC FRONT SIGHT** offers a true, precise sight picture
- **3-SHOT ADAPTOR WITH SPEED-PLUG SYSTEM** is easily removed without tools
- **ROTARY BOLT** with four massive lugs provides strength, support and solid lockup
- **DROP-OUT TRIGGER GROUP** allows for easy cleaning
- **CROSSBOLT SAFETY** is easily operated, even with gloves
- **INFLEX TECHNOLOGY RECOIL PAD** directs "felt recoil" down and away from your cheek to reduce flinch and fatigue



The receiver on the Winchester Super X[®] Pump Universal Hunter shotgun is drilled and tapped for optional Winchester scope bases and rings. See the full line of bases and rings on page 79.

ITEM NUMBER	GAUGE	BARREL LENGTH	CHAMBER	MAGAZINE CAPACITY	CHOKE TUBES INCLUDED	OVERALL LENGTH	LENGTH OF PULL	DROP AT COMB	DROP AT HEEL	NOMINAL WT. (LBS.)	SUGGESTED RETAIL
SXP WATERFOWL HUNTER											
512270291	12	26"	3 1/2"	4*	F, M, IC	47"	13 3/4"	15/8"	2"	6 7/8	\$499.99
512270292	12	28"	3 1/2"	4*	F, M, IC	49"	13 3/4"	15/8"	2"	7	499.99
512270391	12	26"	3"	4*	F, M, IC	46 1/2"	13 3/4"	15/8"	2"	6 3/4	459.99
512270392	12	28"	3"	4*	F, M, IC	48 1/2"	13 3/4"	15/8"	2"	6 7/8	459.99
512270691	20	26"	3"	5*	F, M, IC	46 1/2"	13 3/4"	15/8"	2"	6 1/2	499.99
512270692	20	28"	3"	5*	F, M, IC	48 1/2"	13 3/4"	15/8"	2"	6 5/8	499.99

*TOTAL AMMUNITION CAPACITY INCLUDES ONE ADDITIONAL SHELL IN THE CHAMBER.

ITEM NUMBER	GAUGE	BARREL LENGTH	CHAMBER	MAGAZINE CAPACITY	CHOKE TUBES INCLUDED	OVERALL LENGTH	LENGTH OF PULL	DROP AT COMB	DROP AT HEEL	NOMINAL WT. (LBS.)	SUGGESTED RETAIL
SXP UNIVERSAL HUNTER											
512321290	12	24"	3 1/2"	4*	F, M, IC	45"	13 3/4"	15/8"	2"	6 3/4	\$509.99
512321291	12	26"	3 1/2"	4*	F, M, IC	47"	13 3/4"	15/8"	2"	6 7/8	509.99
512321292	12	28"	3 1/2"	4*	F, M, IC	49"	13 3/4"	15/8"	2"	7	509.99
512321390	12	24"	3"	4*	F, M, IC	44 1/2"	13 3/4"	15/8"	2"	6 5/8	469.99
512321391	12	26"	3"	4*	F, M, IC	46 1/2"	13 3/4"	15/8"	2"	6 3/4	469.99
512321392	12	28"	3"	4*	F, M, IC	48 1/2"	13 3/4"	15/8"	2"	6 7/8	469.99
512321690	20	24"	3"	5*	F, M, IC	46 1/2"	13 3/4"	15/8"	2"	6 3/8	509.99
512321691	20	26"	3"	5*	F, M, IC	44 1/2"	13 3/4"	15/8"	2"	6 1/2	509.99
512321692	20	28"	3"	5*	F, M, IC	48 1/2"	13 3/4"	15/8"	2"	6 5/8	509.99

*TOTAL AMMUNITION CAPACITY INCLUDES ONE ADDITIONAL SHELL IN THE CHAMBER.

CAST A LONG SHADOW.

GET READY TO STEP INTO THE SHADOWS AND BRING HOME A BIG TROPHY.



BLACK SHADOW[®]



- **SYNTHETIC STOCK WITH TEXTURED GRIPPING SURFACES** gives your hands a sure, non-slip grip and the non-glare matte black finish won't spook wary game
- **BACK-BORED TECHNOLOGY** provides optimum shot patterns that are dense and even
- **3" AND 3 1/2" CHAMBER** 12 gauge models give you the magnum advantage to reach out for long-range game
- **INVECTOR-PLUS CHOKE TUBE SYSTEM** offers consistent patterns to match your game and situation
- **HARD CHROME-PLATED CHAMBER AND BORE** make these surfaces highly resistant to wear and corrosion
- **BLACK CHROME PROTECTION** on the bolt and other components lasts longer than traditional bluing

- **BRASS FRONT SIGHT BEAD** offers a fast, natural sight picture
- **3-SHOT ADAPTOR WITH SPEED-PLUG SYSTEM** is easily removed without tools
- **ROTARY BOLT** with four massive lugs provides strength and solid lockup
- **DROP-OUT TRIGGER GROUP** allows for easy cleaning
- **CROSSBOLT SAFETY** is easily operated, even with gloves
- **INFLEX TECHNOLOGY RECOIL PAD** directs "felt recoil" down and away from your cheek to reduce flinch and fatigue



BLACK SHADOW[®] DEER TRUGLO

- **SYNTHETIC STOCK WITH TEXTURED GRIPPING SURFACES** gives your hands a sure, non-slip grip and the non-glare matte black finish won't spook wary game
- **22" FULLY-RIFLED BARREL** is designed to provide optimum accuracy with modern sabots and slugs
- **3" CHAMBER** gives you the ability to reach out for challenging shots
- **BLACK CHROME PROTECTION** on the bolt and other components lasts longer than traditional bluing
- **TRUGLO[®] FIBER-OPTIC FRONT SIGHT AND ADJUSTABLE FIBER-OPTIC REAR SIGHT** offer a fast, natural sight picture

- **ALLOY RECEIVER** is drilled and tapped for scope bases
- **3-SHOT ADAPTOR WITH SPEED-PLUG SYSTEM** is easily removed without tools
- **ROTARY BOLT** with four massive lugs provides strength, support and solid lockup
- **DROP-OUT TRIGGER GROUP** allows for easy cleaning
- **CROSSBOLT SAFETY** is easily operated, even with gloves
- **INFLEX TECHNOLOGY RECOIL PAD** directs "felt recoil" down and away from your cheek



The receiver on the Winchester Super X[®] Pump Black Shadow Deer shotgun is drilled and tapped for Winchester scope bases and rings. See the full line of bases and rings on page 79.



ITEM NUMBER	GAUGE	BARREL LENGTH	CHAMBER	MAGAZINE CAPACITY	CHOKE TUBES INCLUDED	OVERALL LENGTH	LENGTH OF PULL	DROP AT COMB	DROP AT HEEL	NOMINAL WT. (LBS.)	SUGGESTED RETAIL
SXP BLACK SHADOW											
512251290	12	24"	3 1/2"	4*	F, M, IC	44 1/2"	13 3/4"	15/8"	2"	6 3/4	\$399.99
512251291	12	26"	3 1/2"	4*	F, M, IC	47"	13 3/4"	15/8"	2"	6 7/8	399.99
512251292	12	28"	3 1/2"	4*	F, M, IC	49"	13 3/4"	15/8"	2"	7	399.99
512251390	12	24"	3"	4*	F, M, IC	44 1/2"	13 3/4"	15/8"	2"	6 3/4	379.99
512251391	12	26"	3"	4*	F, M, IC	46 1/2"	13 3/4"	15/8"	2"	6 7/8	379.99
512251392	12	28"	3"	4*	F, M, IC	48 1/2"	13 3/4"	15/8"	2"	6 1/2	399.99
512251690	20	24"	3"	5*	F, M, IC	44 1/2"	13 3/4"	15/8"	2"	6 1/2	399.99
512251691	20	26"	3"	5*	F, M, IC	46 1/2"	13 3/4"	15/8"	2"	6 5/8	399.99
512251692	20	28"	3"	5*	F, M, IC	48 1/2"	13 3/4"	15/8"	2"	6 5/8	399.99
SXP BLACK SHADOW DEER											
512261340	12	22"	3"	4**	1:35" RH Twist	43"	13 3/4"	15/8"	2"	6 7/8	\$519.99
512261640	20	22"	3"	5**	1:24" RH Twist	43"	13 3/4"	15/8"	2"	6 5/8	549.99

*TOTAL AMMUNITION CAPACITY INCLUDES ONE ADDITIONAL SHELL IN THE CHAMBER.
 **MAGAZINE CAPACITY DEPENDS ON SHELL LENGTH. SOME SLUGS ARE LONGER THAN STANDARD 2 3/4" SHOT SHELLS.

GET A GRIP.

INCREASE YOUR GRIP WITH AN EXTREME DEER SHOTGUN.

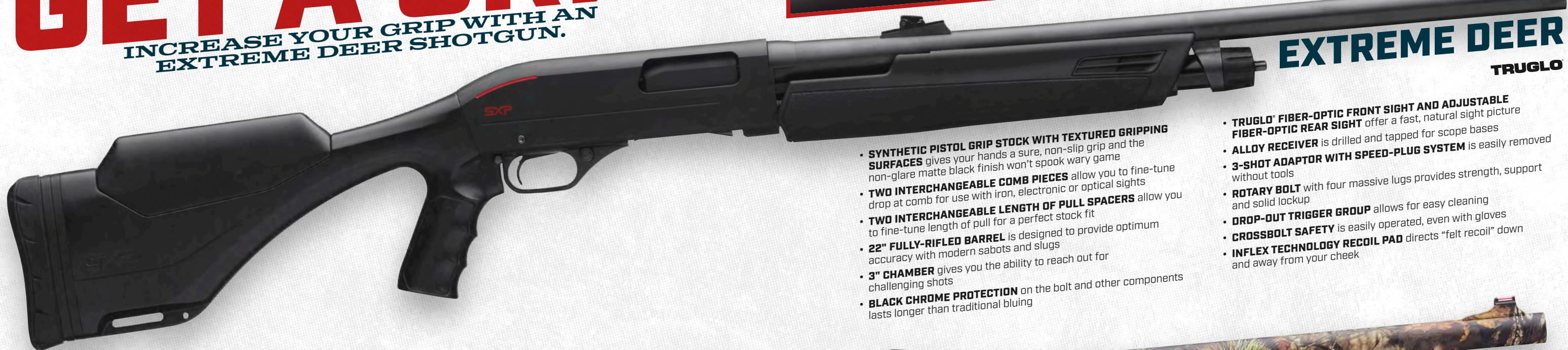

EXTREME DEER TRUGLO

- **SYNTHETIC PISTOL GRIP STOCK WITH TEXTURED GRIPPING SURFACES** gives your hands a sure, non-slip grip and the non-glare matte black finish won't spook wary game
- **TWO INTERCHANGEABLE COMB PIECES** allow you to fine-tune drop at comb for use with iron, electronic or optical sights
- **TWO INTERCHANGEABLE LENGTH OF PULL SPACERS** allow you to fine-tune length of pull for a perfect stock fit
- **22" FULLY-RIFLED BARREL** is designed to provide optimum accuracy with modern sabots and slugs
- **3" CHAMBER** gives you the ability to reach out for challenging shots
- **BLACK CHROME PROTECTION** on the bolt and other components lasts longer than traditional bluing

- **TRUGLO[®] FIBER-OPTIC FRONT SIGHT AND ADJUSTABLE FIBER-OPTIC REAR SIGHT** offer a fast, natural sight picture
- **ALLOY RECEIVER** is drilled and tapped for scope bases
- **3-SHOT ADAPTOR WITH SPEED-PLUG SYSTEM** is easily removed without tools
- **ROTARY BOLT** with four massive lugs provides strength, support and solid lockup
- **DROP-OUT TRIGGER GROUP** allows for easy cleaning
- **CROSSBOLT SAFETY** is easily operated, even with gloves
- **INFLEX TECHNOLOGY RECOIL PAD** directs "felt recoil" down and away from your cheek



Two user-interchangeable combs and height adjustment spacers let you tune the comb height on your Super X[®] Pump Extreme Deer for perfect eye-to-sight alignment with your choice of sighting systems.



EXTREME DEER HUNTER TRUGLO

- **SYNTHETIC PISTOL GRIP STOCK WITH TEXTURED GRIPPING SURFACES** gives your hands a sure, non-slip grip and the Mossy Oak[®] Break-Up Country[™] camo finish won't spook wary game
- **TWO INTERCHANGEABLE COMB PIECES** allow you to fine-tune drop at comb for use with iron, electronic or optical sights
- **TWO INTERCHANGEABLE LENGTH OF PULL SPACERS** allow you to fine-tune length of pull for a perfect stock fit
- **22" FULLY-RIFLED BARREL** is designed to provide optimum accuracy with modern sabots and slugs
- **3" CHAMBER** gives you the ability to reach out for challenging shots
- **BLACK CHROME PROTECTION** on the bolt and other components lasts longer than traditional bluing

- **TRUGLO[®] FIBER-OPTIC FRONT SIGHT AND ADJUSTABLE FIBER-OPTIC REAR SIGHT** offer a fast, natural sight picture
- **ALLOY RECEIVER** is drilled and tapped for scope bases
- **3-SHOT ADAPTOR WITH SPEED-PLUG SYSTEM** is easily removed without tools
- **ROTARY BOLT** with four massive lugs provides strength, support and solid lockup
- **DROP-OUT TRIGGER GROUP** allows for easy cleaning
- **CROSSBOLT SAFETY** is easily operated, even with gloves
- **INFLEX TECHNOLOGY RECOIL PAD** directs "felt recoil" down and away from your cheek

The receivers on both Winchester Super X[®] Pump Extreme Deer shotgun models are drilled and tapped for Winchester scope bases and rings, allowing you to easily attach an optional scope or electronic sight to fully utilize the incredible accuracy of today's shotgun slug ammo. See the full line of bases and rings on page 79.

ITEM NUMBER	GAUGE	BARREL LENGTH	CHAMBER	MAGAZINE CAPACITY	RATE OF TWIST	OVERALL LENGTH	LENGTH OF PULL	DROP AT COMB	DROP AT HEEL	NOMINAL WT. (LBS.)	SUGGESTED RETAIL
SXP EXTREME DEER											
512312340	12	22"	3"	4**	1:35" RH Twist	43"	13 3/4"	1 3/4"	2"	7	\$559.99
SXP EXTREME DEER HUNTER											
512313240	12	22"	3"	4**	1:35" RH Twist	43"	13 3/4"	1 3/4"	2"	7	\$619.99

*TOTAL AMMUNITION CAPACITY INCLUDES ONE ADDITIONAL SHELL IN THE CHAMBER.
 **MAGAZINE CAPACITY DEPENDS ON SHELL LENGTH. SOME SLUGS ARE LONGER THAN STANDARD 2 3/4" SHOT SHELLS.



READY TO GO.

THESE HIGH-TECHNOLOGY PUMPS ARE READY FOR SOME SERIOUS DEFENSE.

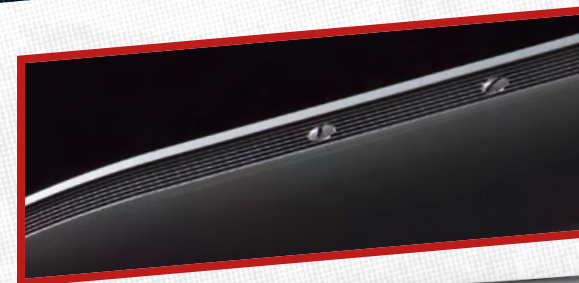

The receivers on both Winchester Super X[®] Pump Shadow Defender[™] shotgun models are drilled and tapped for Winchester scope bases and rings, allowing you to easily attach an optional scope or electronic sight to fully utilize the incredible accuracy of today's shotgun slug ammo. See the full line of bases and rings on page 79.



SHADOW DEFENDER[™]



- **SYNTHETIC PISTOL GRIP STOCK WITH TEXTURED GRIPPING SURFACES** gives your hands a sure, non-slip grip and the non-glare matte black finish won't give you away
- **TWO INTERCHANGEABLE COMB PIECES** allow you to fine-tune drop at comb for use with iron, electronic or optical sights
- **TWO INTERCHANGEABLE LENGTH OF PULL SPACERS** allow you to fine-tune length of pull for a perfect stock fit
- **TACTICAL RIBBED FOREARM** for better control when you need it most
- **HARD CHROME-PLATED CHAMBER AND BORE** make these surfaces highly resistant to wear and corrosion
- **INVECTOR-PLUS CYLINDER CHOKE TUBE** handles both slugs and buckshot

- **3" CHAMBER** gives you the ability to reach out for challenging shots
- **BLACK CHROME PROTECTION** on the bolt and other components lasts longer than traditional bluing
- **REMOVABLE TRUGLO[®] FIBER-OPTIC FRONT SIGHT** plus a traditional brass front bead offer a fast, natural sight picture
- **ALLOY RECEIVER** is drilled and tapped for scope bases
- **ROTARY BOLT** with four massive lugs provides strength, support and solid lockup
- **CROSSBOLT SAFETY** is easily operated, even with gloves
- **INFLEX TECHNOLOGY RECOIL PAD** directs "felt recoil" down and away from your cheek



SHADOW MARINE DEFENDER[™]



- **MATTE HARD CHROME PLATING** on the barrel, magazine tube and slide arms for added resistance to wear and the elements
- **SYNTHETIC PISTOL GRIP STOCK WITH TEXTURED GRIPPING SURFACES** gives your hands a sure, non-slip grip and the non-glare matte black finish won't give you away
- **TWO INTERCHANGEABLE COMB PIECES** allow you to fine-tune drop at comb for use with iron, electronic or optical sights
- **TWO INTERCHANGEABLE LENGTH OF PULL SPACERS** allow you to fine-tune length of pull for a perfect stock fit
- **TACTICAL RIBBED FOREARM** for better control when you need it most
- **HARD CHROME-PLATED CHAMBER AND BORE** make these surfaces highly resistant to wear and corrosion

- **INVECTOR-PLUS CYLINDER CHOKE TUBE** handles both slugs and buckshot
- **3" CHAMBER** gives you the ability to reach out for challenging shots
- **BLACK CHROME PROTECTION** on the bolt and other components lasts longer than traditional bluing
- **REMOVABLE TRUGLO[®] FIBER-OPTIC FRONT SIGHT** plus a traditional brass front bead offer a fast, natural sight picture
- **ALLOY RECEIVER** is drilled and tapped for scope bases
- **ROTARY BOLT** with four massive lugs provides strength, support and solid lockup
- **CROSSBOLT SAFETY** is easily operated, even with gloves
- **INFLEX TECHNOLOGY RECOIL PAD** directs "felt recoil" down and away from your cheek



Two user-interchangeable combs and height adjust spacers let you tune comb height on your Super X[®] Pump Shadow Defender[™] and Shadow Marine Defender[™] for perfect eye-to-sight alignment with your choice of sighting systems.

ITEM NUMBER	GAUGE	BARREL LENGTH	CHAMBER	MAGAZINE CAPACITY	CHOKE TUBES INCLUDED	OVERALL LENGTH	LENGTH OF PULL	DROP AT COMB	DROP AT HEEL	NOMINAL WT. (LBS.)	SUGGESTED RETAIL
SXP SHADOW DEFENDER											
512327395	12	18"	3"	5*	CYL	38 1/2"	13 3/4"	13/8"	15/8"	6 1/4	\$449.99
512327695	20	18"	3"	5*	CYL	38 1/2"	13 3/4"	13/8"	15/8"	6	469.99
SXP SHADOW MARINE DEFENDER											
512328395	12	18"	3"	5*	CYL	38 1/2"	13 3/4"	13/8"	15/8"	6 1/4	\$499.99
512328695	20	18"	3"	5*	CYL	38 1/2"	13 3/4"	13/8"	15/8"	6	519.99

*TOTAL AMMUNITION CAPACITY INCLUDES ONE ADDITIONAL SHELL IN THE CHAMBER.

SHUCKIN' AWE.

SHUCK A SHELL AND WATCH THE BAD GUYS RUN AWAY.



The receivers on both the Winchester Super X[®] Pump Defender™ and Marine Defender™ shotgun models are drilled and tapped for Winchester scope bases and rings. See the full line of bases and rings on page 79.



DEFENDER™

- **TRADITIONAL BRASS BEAD FRONT SIGHT** offers a fast, natural sight picture
- **ROTARY BOLT** with four massive lugs provides strength and solid lockup
- **DROP-OUT TRIGGER GROUP** allows for easy cleaning
- **CROSSBOLT SAFETY** is easily operated, even with gloves
- **BLACK CHROME PROTECTION** on the bolt and other components lasts longer than traditional bluing
- **INFLEX TECHNOLOGY RECOIL PAD** directs "felt recoil" down and away from your cheek to reduce flinch and fatigue
- **SYNTHETIC STOCK WITH TEXTURED GRIPPING SURFACES** gives your hands a sure, non-slip grip and the non-glare matte black finish won't reveal your position
- **TACTICAL RIBBED FOREARM** for better control when you need it most
- **HARD CHROME-PLATED CHAMBER AND BORE** make these surfaces highly resistant to wear and corrosion
- **FIXED-CYLINDER CHOKED** barrel handles both slugs and buckshot
- **ALLOY RECEIVER** is drilled and tapped for scope bases



MARINE DEFENDER™



- **REMOVABLE TRUGLO® FIBER-OPTIC FRONT SIGHT** plus a traditional brass front bead offer a fast, natural sight picture
- **INVECTOR-PLUS CHOKE TUBE SYSTEM** with cylinder choke installed, works with slugs or buckshot
- **ROTARY BOLT** with four massive lugs provides strength and solid lockup
- **DROP-OUT TRIGGER GROUP** allows for easy cleaning
- **CROSSBOLT SAFETY** is easily operated, even with gloves
- **INFLEX TECHNOLOGY RECOIL PAD** directs "felt recoil" down and away from your cheek to reduce flinch and fatigue
- **SYNTHETIC STOCK WITH TEXTURED GRIPPING SURFACES** gives your hands a sure, non-slip grip and the non-glare matte black finish won't give you away
- **TACTICAL RIBBED FOREARM** for better control when you need it most
- **HARD CHROME-PLATED CHAMBER AND BORE** make these surfaces highly resistant to wear and corrosion
- **ALLOY RECEIVER** is drilled and tapped for scope bases

ITEM NUMBER	GAUGE	BARREL LENGTH	CHAMBER	MAGAZINE CAPACITY	CHOKE TUBES INCLUDED	OVERALL LENGTH	LENGTH OF PULL	DROP AT COMB	DROP AT HEEL	NOMINAL WT. (LBS.)	SUGGESTED RETAIL
SXP DEFENDER											
512252395	12	18"	3"	5*	N/A	38 1/2"	13 3/4"	13/8"	15/8"	6 1/4	\$349.99
512252695	20	18"	3"	5*	N/A	38 1/2"	13 3/4"	13/8"	15/8"	6	379.99
SXP MARINE DEFENDER											
512268395	12	18"	3"	5*	CYL	38 1/2"	13 3/4"	13/8"	15/8"	6 1/4	\$399.99
512268695	20	18"	3"	5*	CYL	38 1/2"	13 3/4"	13/8"	15/8"	6	429.99

*TOTAL AMMUNITION CAPACITY INCLUDES ONE ADDITIONAL SHELL IN THE CHAMBER.

THUMP A TOM.

CHECK OUT THIS TRIO OF TOM TAKERS.



TURKEY



- **SYNTHETIC STOCK WITH TEXTURED GRIPPING SURFACES** gives your hands a sure, non-slip grip and is available in your choice of either Mossy Oak[®] Break-Up Country[®] or Obsession[®] camo or a non-glare matte black finish that won't scare off skittish birds
- **BACK-BORED TECHNOLOGY** provides optimum shot patterns that are dense and even
- **A 3" CHAMBER IN 20 GAUGE, OR A 3 1/2" CHAMBER IN 12 GAUGE** gives you the power to reach out for those long-range turkeys
- **INVECTOR-PLUS EXTRA-FULL TURKEY CHOKE TUBE** for a tight, dense pattern
- **HARD CHROME-PLATED CHAMBER AND BORE** make these surfaces highly resistant to wear and corrosion

- **ALLOY RECEIVER** is drilled and tapped for scope bases
- **TRUGLO[®] FIBER-OPTIC ADJUSTABLE SIGHTS** offer a fast, natural sight picture
- **ROTARY BOLT** with four massive lugs provides strength and solid lockup
- **DROP-OUT TRIGGER GROUP** allows for easy cleaning
- **CROSSBOLT SAFETY** is easily operated, even with gloves
- **BLACK CHROME PROTECTION** on the bolt and other components lasts longer than traditional bluing
- **INFLEX TECHNOLOGY RECOIL PAD** directs "felt recoil" down and away from your cheek to reduce flinch and fatigue



TURKEY HUNTER



Two user-interchangeable combs and height adjustment spacers let you tune comb height on your Super X[®] Pump Long Beard[™] for perfect eye-to-sight alignment with your choice of sighting systems.



LONG BEARD[™]



- **SYNTHETIC PISTOL GRIP STOCK WITH TEXTURED GRIPPING SURFACES** gives your hands a sure, non-slip grip and the Mossy Oak[®] Break-Up Country[®] camo finish won't spook wary birds
- **TWO INTERCHANGEABLE COMB PIECES** allow you to fine-tune drop at comb for use with iron, electronic or optical sights
- **TWO INTERCHANGEABLE LENGTH OF PULL SPACERS** allow you to fine-tune length of pull for a perfect stock fit
- **BACK-BORED TECHNOLOGY** provides optimum shot patterns that are dense and even
- **CHOICE OF 3" OR 3 1/2" CHAMBER** gives you the power to reach out for those long-range turkeys
- **INVECTOR-PLUS EXTRA-FULL LONG BEARD[™] TURKEY CHOKE TUBE** for a tight, dense pattern, especially with Winchester[®] Long Beard[®] XR[®] ammunition

- **HARD CHROME-PLATED CHAMBER AND BORE** make these surfaces highly resistant to wear and corrosion
- **ALLOY RECEIVER** is drilled and tapped for scope bases
- **TRUGLO[®] FIBER-OPTIC ADJUSTABLE SIGHTS** offer a fast, natural sight picture
- **ROTARY BOLT** with four massive lugs provides strength and solid lockup
- **DROP-OUT TRIGGER GROUP** allows for easy cleaning
- **CROSSBOLT SAFETY** is easily operated, even with gloves
- **BLACK CHROME PROTECTION** on the bolt and other components lasts longer than traditional bluing
- **INFLEX TECHNOLOGY RECOIL PAD** directs "felt recoil" down and away from your cheek to reduce flinch and fatigue

LONG BEARD[™] CHOKE TUBE
Aggressively avid turkey hunters will go to great lengths to tag that trophy tom. The Winchester Super X[®] Pump Long Beard[™] model features an extended Extra-Full Turkey tube with a fluted body, knurled friction ring and camo front band. It's designed to extract every bit of potential from Winchester's Long Beard[®] XR[®] turkey ammunition.

ITEM NUMBER	GAUGE	BARREL LENGTH	CHAMBER	MAGAZINE CAPACITY	CHOKE TUBES INCLUDED	OVERALL LENGTH**	LENGTH OF PULL	DROP AT COMB	DROP AT HEEL	NOMINAL WT. (LBS.)	SUGGESTED RETAIL
SXP TURKEY											
512341290	12	24"	3 1/2"	4*	T	45"	13 3/4"	1 5/8"	2"	6 5/8	\$439.99
512341690	20	24"	3"	5*	T	44 1/2"	13 3/4"	1 5/8"	2"	6 1/4	439.99
SXP TURKEY HUNTER MOSSY OAK BREAK-UP COUNTRY											
512307290	12	24"	3 1/2"	4*	T	45"	13 3/4"	1 5/8"	2"	6 5/8	\$519.99
512307690	20	24"	3"	5*	T	44 1/2"	13 3/4"	1 5/8"	2"	6 1/4	519.99
SXP TURKEY HUNTER MOSSY OAK OBSESSION											
NEW 512357290	12	24"	3 1/2"	4*	T	45"	13 3/4"	1 5/8"	2"	6 5/8	\$519.99
NEW 512357690	20	24"	3"	5*	T	44 1/2"	13 3/4"	1 5/8"	2"	6 1/4	519.99

*TOTAL AMMUNITION CAPACITY INCLUDES ONE ADDITIONAL SHELL IN THE CHAMBER. **OVERALL LENGTH DOES NOT INCLUDE CHOKE TUBE.

ITEM NUMBER	GAUGE	BARREL LENGTH	CHAMBER	MAGAZINE CAPACITY	CHOKE TUBES INCLUDED	OVERALL LENGTH**	LENGTH OF PULL	DROP AT COMB	DROP AT HEEL	NOMINAL WT. (LBS.)	SUGGESTED RETAIL
SXP LONG BEARD MOSSY OAK BREAK-UP COUNTRY											
512320290	12	24"	3 1/2"	4*	Long Beard	44 1/2"	13 3/4"	1 3/4"	2"	7 1/4	\$559.99
512320390	12	24"	3"	4*	Long Beard	44"	13 3/4"	1 3/4"	2"	7 1/4	529.99
NEW 512320690	20	24"	3"	5*	Long Beard	44"	13 3/4"	1 3/4"	2"	7 1/4	559.99
SXP LONG BEARD MOSSY OAK OBSESSION											
NEW 512352290	12	24"	3 1/2"	4*	Long Beard	44 1/2"	13 3/4"	1 3/4"	2"	7 1/4	\$559.99
NEW 512352390	12	24"	3"	4*	Long Beard	44"	13 3/4"	1 3/4"	2"	7 1/4	529.99
NEW 512352690	20	24"	3"	5*	Long Beard	44"	13 3/4"	1 3/4"	2"	7 1/4	559.99

*TOTAL AMMUNITION CAPACITY INCLUDES ONE ADDITIONAL SHELL IN THE CHAMBER. **OVERALL LENGTH DOES NOT INCLUDE CHOKE TUBE.

MODEL 101™

THE OVER AND UNDER THAT REDEFINES ELEGANCE.

Few of us ever get to experience the look, the feel, the exceptional quality and the lasting performance of a fine Belgian-made over and under. Now you can put the perfect stackbarrel in your gun rack at a price that won't break your budget. Built along the classic lines of the legendary original, today's Model 101™ uses the latest in manufacturing processes and materials to become the over and under that you've always dreamed of owning but never thought you could afford.



Today's Model 101™ features the same **FAMILIAR DIMENSIONS** set long ago by the original. The familiar drop at comb and narrow grip ensure time-tested comfort and performance.



The Model 101™ has the drop on the original with the advantage of a **LOW-PROFILE RECEIVER**. This means that recoil occurs in-line, directly back for faster follow-up shots with less muzzle jump. Also, your forward hand is placed closer to the bore centerline, bringing your hands, face and sighting plane into a more natural alignment for intuitive and accurate shooting.



An **ADJUSTABLE COMB** stock allows you to modify individual height and cast on/off for a custom fit in just seconds. (Hex wrench is included.)

Every Model 101™ shotgun has **FINELY CUT CHECKERING** to improve grip and add artistic elegance to the well-figured walnut stock and forearm.



Getting pounded by recoil is now a thing of the past with the patented **PACHMAYR RECOIL PAD** found on all Model 101™ shotguns. The Pachmayr pad on the Sporting model has a snag-free heel for fast and easy shouldering.



An **ADJUSTABLE TRIGGER SHOE** lets you fine tune its fore and aft position to your precise length of pull for more comfortable shooting on Pigeon and Sporting models. (Hex wrench is included.)



Sporting and Field models have a fitted **STEEL GRIP CAP** to add a touch of graceful elegance.

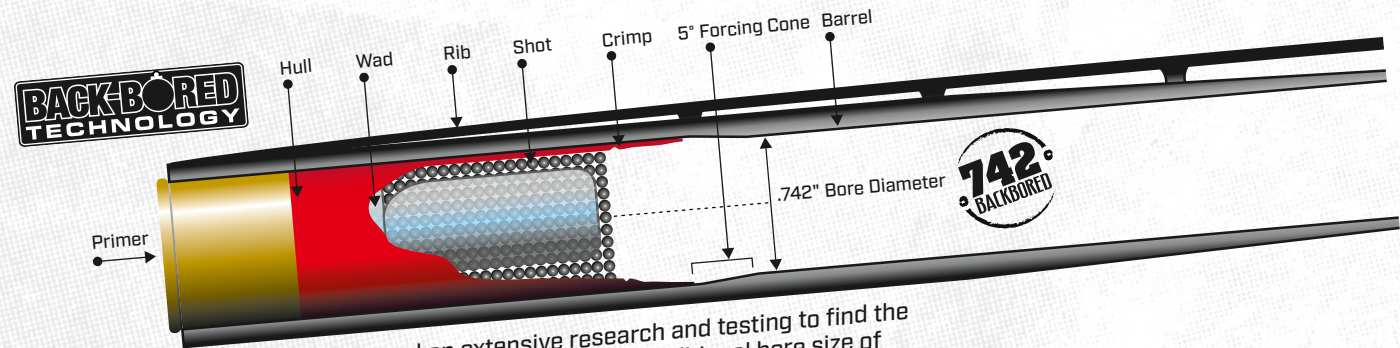

BACK-BORED TECHNOLOGY is based on extensive research and testing to find the secret to tighter, more consistent patterns. Instead of the traditional bore size of .729", this research shows the ideal 12 gauge interior diameter is .742". If the bore is any larger the gases will blow by the shot cup and reduce pellet velocity. If the bore is too tight the pellets are deformed as they pass through the forcing cone, causing poor ballistic performance.

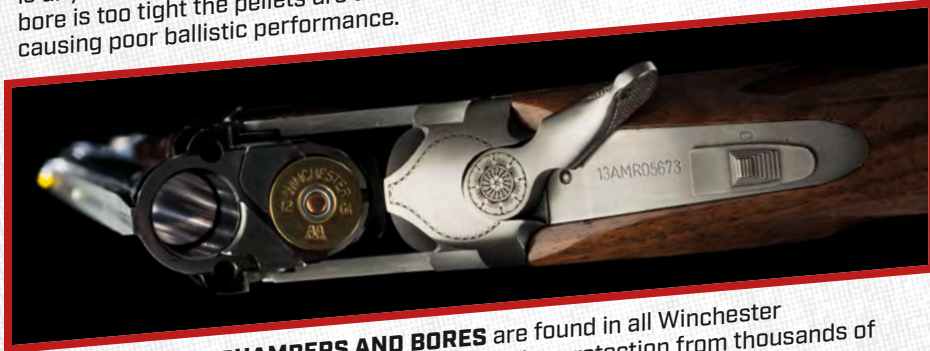

CHROME-PLATED CHAMBERS AND BORES are found in all Winchester Model 101™ shotguns. This critical plating provides protection from thousands of heavy, high density, abrasive loads. This extra feature virtually eliminates wear and tear caused by thousands of shells.



TOUGH STEEL HINGE areas bear tension from recoil with each shot, so the Model 101™ shotgun is built with surfaces that are 49% larger than many competitors. The surfaces are machined simultaneously with the hinge, ensuring perfect alignment.



The Model 101™ shotgun's **LOCKING LUGS** have 30% more contact surface than the competition for an action that's the strongest in the industry and built to last.



From the field to the range, the **INVECTOR-PLUS CHOKE TUBE SYSTEM** is the world's most consistent. All Model 101™ shotguns come with either extended Signature or flush-mounted Invector-Plus tubes, depending on the model. Additional tubes are available at your local firearms dealer.



TRUGLO Model 101™ Pigeon Trap and Sporting models feature **TRUGLO FIBER-OPTIC FRONT SIGHTS** for faster target acquisition.

DOUBLE YOUR FUN.

GET READY TO DOUBLE DOWN ON EVERY CLAY TARGET THROWN.



PIGEON TRAP



- **HIGH GLOSS GRADE II/III WALNUT STOCK WITH 20 LINES-PER-INCH CUT CHECKERING** looks elegant and improves grip
- **ADJUSTABLE COMB OPTION** lets you custom fit the stock to your shooting style
- **LOW-PROFILE NICKEL-PLATED RECEIVER WITH CLASSIC PIGEON ENGRAVING** gives you faster target acquisition, a more controlled swing and less "felt recoil"
- **TRUGLO™ TRU-BEAD™ INTERCHANGEABLE FIBER-OPTIC FRONT SIGHT** offers a true, precise sight picture
- **TRADITIONAL MODEL 101™ SHOTGUN DIMENSIONS** give you a performance advantage plus classic styling

- **EXTENDED SIGNATURE INVECTOR-PLUS CHOKE TUBES** offer predictable patterns to match your situation
- **BACK-BORED BARRELS** provide optimum shot patterns that are dense and even
- **PORTED BARRELS** reduce muzzle jump and help tame "felt recoil"
- **ADJUSTABLE TRIGGER** for perfect length of pull
- **HARD CHROME-PLATED CHAMBERS AND BORES** make these surfaces highly resistant to wear and corrosion
- **WHITE LINE SPACER PACHMAYR™ DECELERATOR™ RECOIL PAD** provides optimal protection against felt recoil

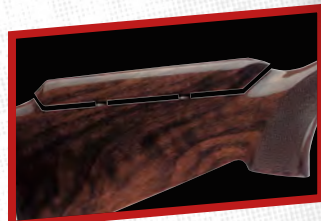

Model 101® Pigeon Trap adjustable comb.



SPORTING



- **HIGH GLOSS GRADE II/III WALNUT STOCK WITH 20 LINES-PER-INCH CUT CHECKERING** looks elegant and improves grip
- **TRADITIONAL MODEL 101™ SHOTGUN DIMENSIONS** give you a performance advantage plus classic styling
- **LOW-PROFILE RECEIVER** gives you faster target acquisition, a more controlled swing and less "felt recoil"
- **TRUGLO™ TRU-BEAD™ INTERCHANGEABLE FIBER-OPTIC FRONT SIGHT** offers a fast, natural sight picture
- **BACK-BORED TECHNOLOGY** provides optimum shot patterns that are dense and even
- **STEEL GRIP CAP** adds a touch of classic elegance

- **EXTENDED SIGNATURE INVECTOR-PLUS CHOKE TUBES** offer predictable patterns to match your situation
- **ADJUSTABLE TRIGGER SHOE** for perfect length of pull
- **HARD CHROME-PLATED CHAMBERS AND BORES** make these surfaces highly resistant to wear and corrosion
- **49% MORE HINGE SURFACE AREA** than our competitors, giving you greater strength for long-term wear
- **30% MORE LOCKING LUG CONTACT AREA** keeps the action tighter and minimizes wear
- **PACHMAYR™ DECELERATOR™ RECOIL PAD** absorbs felt recoil to reduce flinch and fatigue



Every Model 101™ Sporting and Pigeon Trap shotgun comes with a durable, fitted ABS hard case imprinted with the Winchester Repeating Arms® logo.

ITEM NUMBER	GAUGE	BARREL LENGTH	CHAMBER	CHOKE TUBES INCLUDED	OVERALL LENGTH**	LENGTH OF PULL	DROP AT COMB	DROP AT HEEL	NOMINAL WT. (LBS.)	SUGGESTED RETAIL
MODEL 101 PIGEON TRAP										
513057493	12	30"	2 3/4"	XF, F, IM	47 5/8"	14 5/8"	11/2"	2 3/8"	7 1/2	\$2,519.99
513057494	12	32"	2 3/4"	XF, F, IM	49 5/8"	14 5/8"	11/2"	2 3/8"	7 5/8	2,519.99
MODEL 101 PIGEON TRAP (ADJUSTABLE COMB)										
513059493	12	30"	2 3/4"	XF, F, IM	47 5/8"	14 5/8"	11/2"*	2 3/8"*	7 1/2	\$2,679.99
513059494	12	32"	2 3/4"	XF, F, IM	49 5/8"	14 5/8"	11/2"*	2 3/8"*	7 5/8	2,679.99
MODEL 101 SPORTING										
513054492	12	28"	2 3/4"	LF, IM, M, IC, SK	45 5/8"	14 5/8"	13/8"	2 3/8"	7 1/8	\$2,379.99
513054493	12	30"	2 3/4"	LF, IM, M, IC, SK	47 5/8"	14 5/8"	13/8"	2 3/8"	7 1/4	2,379.99
513054494	12	32"	2 3/4"	LF, IM, M, IC, SK	49 5/8"	14 5/8"	13/8"	2 3/8"	7 3/8	2,379.99

*ADJUSTABLE COMB STOCK DIMENSIONS ARE MEASURED WITH COMB IN THE LOWEST POSITION. **DOES NOT INCLUDE ADDED LENGTH OF CHOKE TUBES.



FIELD OF DREAMS.

FULFILL YOUR DREAM OF DROPPING A RISING ROOSTER WITH A CLASSIC WINCHESTER®



- **HIGH GLOSS GRADE II/III WALNUT STOCK WITH 20 LINES-PER-INCH CUT CHECKERING** looks elegant and improves grip
- **LOW-PROFILE RECEIVER** gives you faster target acquisition, a more controlled swing and less "felt recoil"
- **STEEL GRIP CAP** adds a classic touch
- **BACK-BORED BARRELS** provide optimum shot patterns that are dense and even
- **HARD CHROME-PLATED CHAMBERS AND BORES** make these surfaces highly resistant to wear and corrosion

- **INVECTOR-PLUS CHOKE TUBES** offer predictable patterns to match your situation
- **49% MORE HINGE SURFACE AREA** than our competitors, giving you greater strength for long-term wear
- **30% MORE LOCKING LUG CONTACT AREA** keeps the action tighter and minimizes wear
- **WHITE LINE SPACER PACHMAYR® DECELERATOR® RECOIL PAD** provides optimal protection against "felt recoil"

ITEM NUMBER	GAUGE	BARREL LENGTH	CHAMBER	CHOKE TUBES INCLUDED	OVERALL LENGTH	LENGTH OF PULL	DROP AT COMB	DROP AT HEEL	NOMINAL WT. (LBS.)	SUGGESTED RETAIL
MODEL 101 FIELD										
513046371	12	26"	3"	F, M, IC	43 1/4"	14 1/4"	1 3/8"	2 3/8"	6 3/4	\$1,899.99
513046361	12	28"	3"	F, M, IC	45 1/4"	14 1/4"	1 3/8"	2 3/8"	7	1,899.99

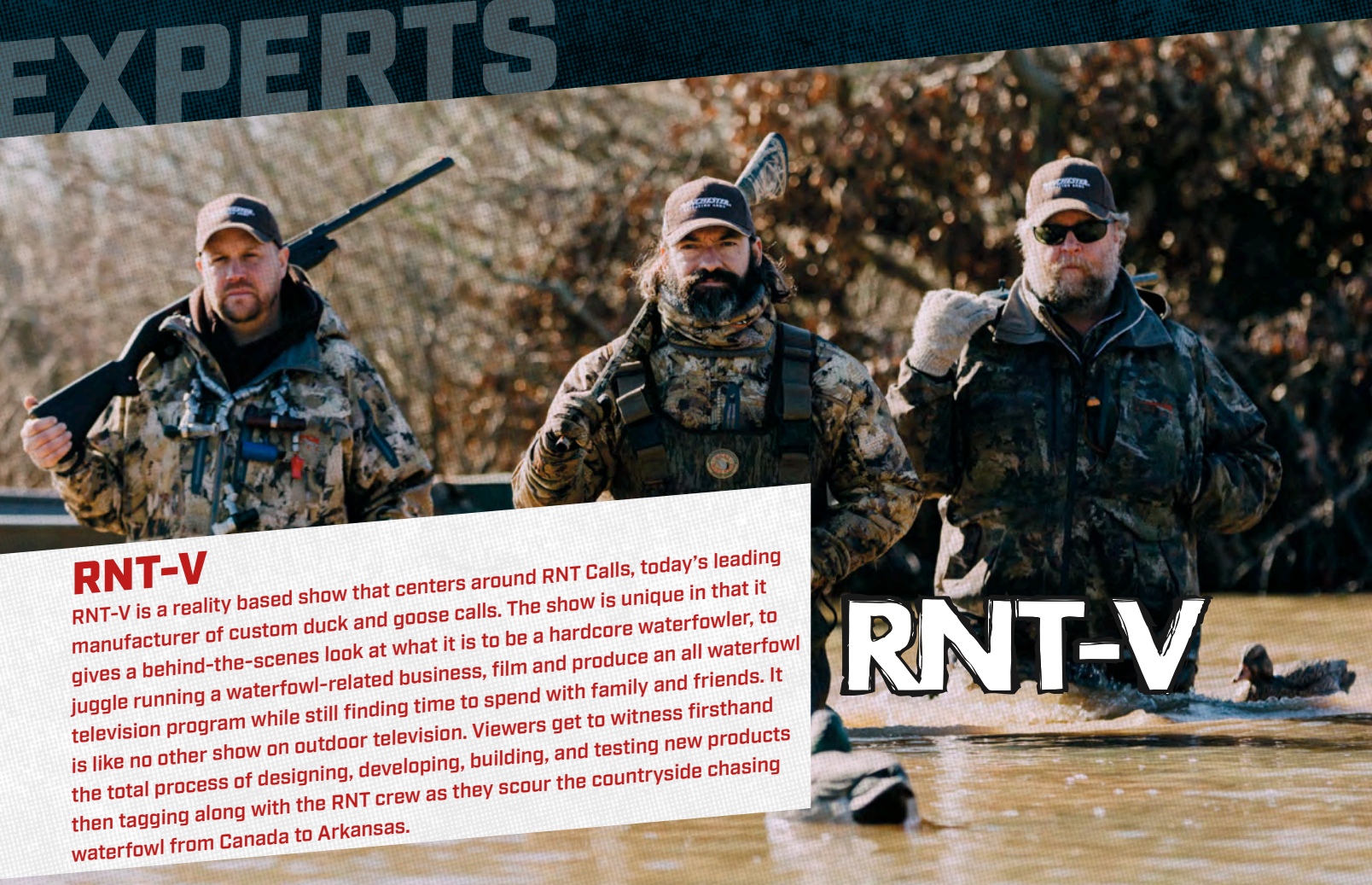

RNT-V

RNT-V is a reality based show that centers around RNT Calls, today's leading manufacturer of custom duck and goose calls. The show is unique in that it gives a behind-the-scenes look at what it is to be a hardcore waterfowler, to juggle running a waterfowl-related business, film and produce an all waterfowl television program while still finding time to spend with family and friends. It is like no other show on outdoor television. Viewers get to witness firsthand the total process of designing, developing, building, and testing new products then tagging along with the RNT crew as they scour the countryside chasing waterfowl from Canada to Arkansas.

RNT-V



WINCHESTER® DEADLY PASSION

Melissa Bachman is an accomplished huntress with a unique ability to share her love for the great outdoors and all things wild with her passionate fans and viewers. Growing up in central Minnesota, surrounded by an avid hunting family filled with love and mentors galore, Melissa pursued her academic life with the same moxie as her passion for hunting. After graduating with honors and armed with degrees in both television broadcasting and Spanish from St. Cloud State University, she trained her sights on a career in outdoor television. Now Melissa spends nearly 200 days a year in the field, hunting, producing and editing for her television show "Winchester Deadly Passion."



DRURY OUTDOORS

Take four members of the Drury family — Mark, Terry, Taylor and Matt — add a passion for hunting and sharing the adventure of the hunt with viewers, and you have one of the most popular and innovative family-oriented outdoor programs on TV today. If you love hunting whitetails and turkeys, you'll enjoy spending time with Winchester® and the whole DOD Team.



WINCHESTER® WORLD OF WHITETAIL

"Winchester World of Whitetail" is a hard-core whitetail hunting series featuring low-fence spot-and-stalk action with hosts Ron Spomer and Allen Treadwell. Follow along as they hunt top whitetail locations across the country, hot on the trail of big deer. Ron and Allen are true whitetail experts who reveal their secrets and tricks of the trade for finding and harvesting mature bucks. We'll also vicariously shadow Ron and Allen as they connect with family and friends, prep for their hunts, and showcase their strategies and techniques that allow them continuous success. "Winchester World of Whitetail" combines the legendary performance of Winchester with America's favorite big-game species.

DROPPED

DROPPED

Brothers Chris and Casey Keefer are well-known personalities in the outdoor and hunting world. After their boyhoods spent hunting and playing ice hockey, the pair has begun to live out their dreams and springboard their lifelong passion for the outdoors into successful careers in big-game guiding, broadcasting and as respected pro-staffers for Winchester Repeating Arms.® Their current TV series *Dropped* literally drops the pair into some of North America's most rugged environments where they must survive by their woodcraft, wits and hunting skills, often for weeks at a time.



WINCHESTER® LIFE

For many people, Winchester is a lifestyle. *Winchester Life* is a new TV series that makes nature and wildlife the stars. Hosts Chris and Casey Keefer, Pete Alfano, Paul Sawyer and Nikki Boxler use epic locations and exciting hunts to bring clarity to the outdoor experience and connect at an emotional level with the viewer.



CUSTOMER SERVICE FOR WINCHESTER® FIREARMS

Expect the same great customer service you've become accustomed to over the years. Expert gunsmiths can help you with the most technical problems and repairs to your firearms. There are many Authorized Repair Centers (ARC) throughout the country with gun repair professionals who know your firearm inside and out. If you need service on current models, as well as older Model 70, Model 94, Model 9422 or Model 1300 firearms, please contact one of the Authorized Repair Centers or our main Service Center in Arnold, Missouri. Please call (800) 333-3288 or visit online at <http://www.winchesterguns.com/customerservice/partsservice/index.asp> for more information.

WINCHESTER REPEATING ARMS®
Customer Service Department
275 Winchester Avenue
Morgan, UT 84050
(800) 945-5237
(801) 876-3440

Parts and Service
3005 Arnold Tenbrook Road
Arnold, MO 63010
(800) 322-4626

FOR FIREARMS: WINCHESTERGUNS.COM
FOR AMMUNITION: WINCHESTER.COM

Owner's manuals for all Winchester® firearms in this or previous catalogs are available upon request at no charge. Owners of Winchester firearms without owner's manuals are encouraged to view one online or request one from our Customer Service Department. Some models and calibers are only made periodically. Winchester Repeating Arms (WRA) reserves the right to delay, postpone or discontinue production of any Winchester firearm for any reason, and to modify or change product specifications (including those listed in this catalog) without notice. Weights, stock dimensions, wood appearance, etc., may vary slightly between individual firearms. Wood is a natural product. No two pieces are alike and variation between stocks is to be expected. WRA will make every reasonable effort to make sure this catalog is accurate at the time of printing and apologizes for any errors in photographs, descriptions and specifications.

Please note that the following models are or were manufactured in Japan: Models 1866, 1873, 1885, 1886, 1892, 1894, 1895, 63 and 52B. Super X2, Super X3, Super X4 and 101 shotguns are or were manufactured in Belgium and assembled in Portugal. Model 70 rifles are manufactured in the USA or in Portugal. The following trademarks are used with permission from Olin Corporation: Winchester, the Horse and Rider design, Super X, SX2 design, Super X2, SX3 design, Super X3, SX4 design, Super X4, Model 1892, Select, Model 101, Model 1300, Model 94, Model 70, Super X Pump, Long Beard, XPR, XPC and the red W design. Other trademarks used in this catalog: Mossy Oak Shadow Grass Blades, Mossy Oak Break-Up Infinity, Mossy Oak Break-Up Country, Mossy Oak Bottomland and Mossy Oak Duck Blind are registered trademarks of Haas Outdoors. Pachmayr and Decelerator are registered trademarks of Lyman. Invector-Plus, Dura-Touch and Perma-Cote are trademarks of Browning. TRUGLO is a trademark of TRUGLO, Inc. Marble Arms is a trademark of Marbles Arms. Weaver is a registered trademark of Vista Outdoor. Magpul, PRS, MOE-K, M-LOK, AC are trademarks of Magpul. AICS is a trademark of Accuracy International.

© Copyright, WRA, August 2017. No part of this catalog may be reproduced without the written permission of Winchester Repeating Arms. Suggested retail pricing is in U.S. dollars, are approximate and subject to change without notice. Printed in USA. CG1708100/17006 Winchester firearms are imported by BACD, Inc. Winchester is a registered trademark of Olin Corporation.

A portion of the sale of every Winchester firearm is proudly donated to the Heritage Fund, which helps to expand the legal defense against politically motivated lawsuits against the hunting and shooting industry. Working together, the rightful tradition of firearms in America will continue.



ALL WINCHESTER® FIREARMS ARE SHIPPED WITH A FREE LOCKING DEVICE TO ASSIST IN THE SAFE STORAGE OF FIREARMS. (NOT SHOWN ACTUAL SIZE.)





WINCHESTER
WE KNOW
BOLTS

WINCHESTER REPEATING ARMS
275 WINCHESTER AVE., MORGAN, UT
84050-9333