



WINCHESTER[®]

REPEATING ARMS



2014

DAVID JACKSON

2014 WINCHESTER REPEATING ARMS.®

WE'RE BRINGING HISTORY TO LIFE.

2014 is another exciting year for Winchester Repeating Arms fans. The new Super X® Pump Field Compact shotgun opens up new horizons for hosts of smaller shooters. Those who revel in the rich history of Winchester Repeating Arms lever-actions will love the new Model 1873 Color Case Hardened rifle with its spectacular metalwork. Two new Model 1892® rifles, the Short Rifle and the Large Loop Carbine will bring smiles to the faces of Cowboy Action Shooters and saddle gun lovers alike. It's high time to put those off-brand replica rifles out to pasture. Remember, like the originals, if it doesn't say Winchester Repeating Arms on the barrel it isn't the real deal.



**SUPER X®
PUMP FIELD**



**SUPER X®3
SPORTING**



**MODEL 101®
PIGEON TRAP**

SUPER X® PUMP	02-13
TECHNICAL FEATURES	02-03
FIELD / FIELD COMPACT	04-05
WATERFOWL HUNTER	06-07
BLACK SHADOW / BLACK SHADOW DEER	08-09
DEFENDER / MARINE DEFENDER	10-11
TURKEY HUNTER	12-13

SUPER X®3	14-25
TECHNICAL FEATURES	14-15
SPORTING	16-17
FIELD / FIELD COMPACT	18-19
BLACK SHADOW / CANTILEVER BUCK	20-21
WATERFOWL HUNTER / UNIVERSAL HUNTER	22-23
NWTF® CANTILEVER TURKEY	24-25

MODEL 101®	26-31
TECHNICAL FEATURES	26-27
PIGEON TRAP / SPORTING	28-29
FIELD	30-31



ABOUT THE COVER

Winchester Repeating Arms® has always been at the forefront of wildlife and habitat conservation efforts. For 2014, Winchester Repeating Arms has commissioned *Ladies' Man* an original oil painting by noted outdoor artist David W. Jackson. The original painting will be donated to the National Wild Turkey Federation to support their conservation of the wild turkey and the preservation of America's hunting heritage.

A professional artist for more than 40 years, Jackson taught high school art courses for 27 years before retiring to pursue his art full time. His richly-colored style of impressionist realism appeals to collectors from all walks of life, and his work is held in numerous private and public collections throughout the United States, Canada and Europe.

A father of four and grandfather to seven, Jackson resides with his wife, Jeaneil, just down the road from the Winchester Repeating Arms corporate campus in beautiful Mountain Green, Utah. Like so many of us, he is a member and avid supporter of numerous wildlife and conservation causes like the NWTf.

You can see more of his work at www.davidjacksonstudio.com.



MODEL 1873 COLOR CASE HARDENED

HISTORICAL	32-43
TECHNICAL FEATURES / OVERVIEW	32-33
1873 SHORT RIFLE / COLOR CASE HARDENED	34-35
1885 RIMFIRE / 1886 SHORT RIFLE	36-37
1892 SHORT RIFLE / 1892 LARGE LOOP CARBINE	38-39
94 TRAILS END TAKEDOWN / 94 CARBINE	40-41
94 SPORTER / 94 SHORT RIFLE	42-43



MODEL 70® SUPER GRADE

MODEL 70®	44-57
TECHNICAL FEATURES	44-45
SUPER GRADE / SPORTER	46-47
SAFARI EXPRESS / ALASKAN	48-49
FEATHERWEIGHT / FEATHERWEIGHT COMPACT	50-51
EXTREME WEATHER SS / COYOTE LIGHT	52-53
ULTIMATE SHADOW HUNTER SS / HUNTER	54-55
ULTIMATE SHADOW / ULTIMATE SHADOW SS	56-57



ACCESSORIES

CHOKE TUBES / MAGAZINES	58
BASES AND RINGS	59
EXTRA BARRELS	60

SUPER X[®] PUMP

THE FASTEST
PUMP ACTION
— PERIOD.

Nothing in the world sounds like shucking a shell into the chamber of a pump shotgun. The Winchester[®] Super X Pump shotgun is the perfect solution for pump fans with its smooth as glass feel and ultra-reliable inertia-assisted slide action. Three shots can be delivered in just a half second, a blistering pace that no other pump can match. Your shooting buddies may think your Super X Pump shotgun has autoloader speed. You know it does.

WANNA
SEE
FAST?
Scan this ▶



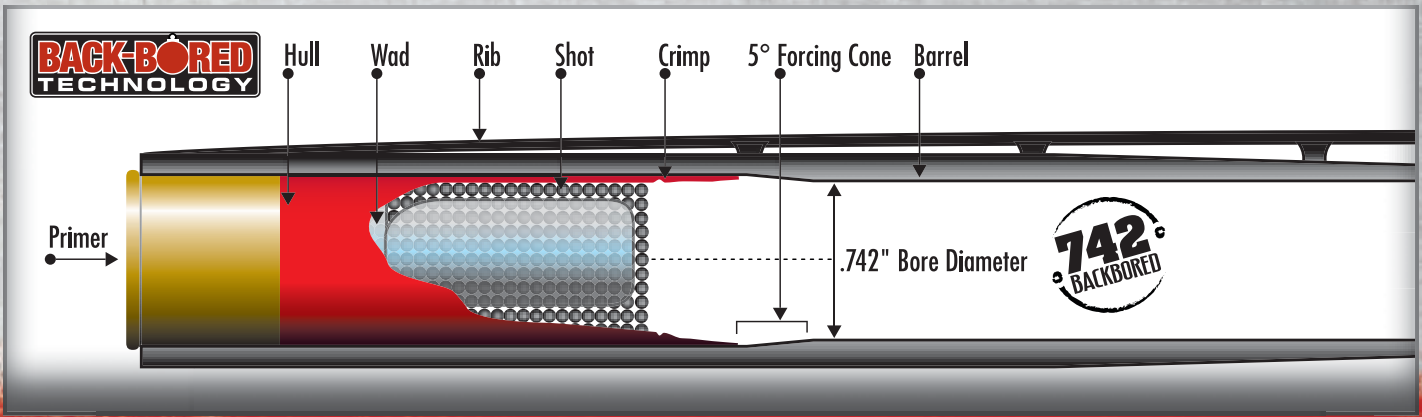

.742" BACK-BORED TECHNOLOGY is based on extensive research and testing. When it comes to back-boring shotgun barrels, .742" is the ideal 12 gauge interior diameter to ensure tight, consistent patterns. Any larger and gases blow by the shot cup and reduce pellet velocity. Too tight and the pellets are deformed as they pass through the forcing cone, causing poor ballistic performance.



HARD CHROME CHAMBER AND BORE are critical for today's steel or Hi-Density (HD) shot. Hard chrome makes the surfaces highly resistant to wear and gives you superior protection from rust and corrosion. That's why all smoothbore Super X[®] Pump shotguns feature a hard-chromed chamber and bore.



From the duck blind to the firing line, the **INVECTOR-PLUS™ CHOKE TUBE SYSTEM** is the world's most consistent. The Super X[®] Pump shotgun comes with full, modified and improved cylinder flush-mounted choke tubes so your gun is ready for anything, right out of the box. Additional choke tubes are available at your local Winchester Repeating Arms dealer.

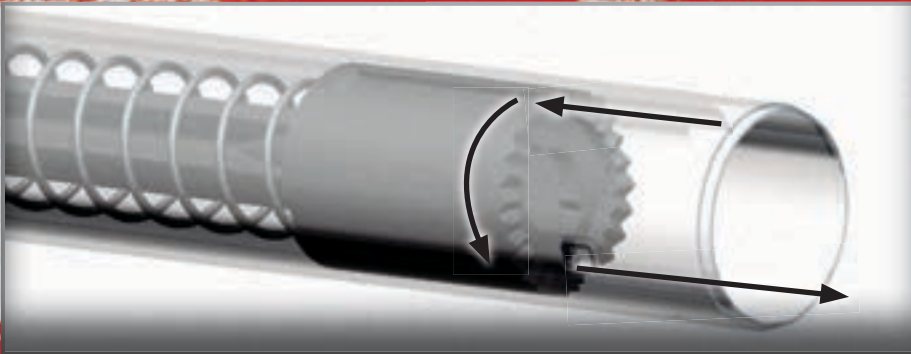

SPEED-PLUG SYSTEM lets you remove the three-shot adaptor with your fingers. Just remove the magazine cap, push on the spring retainer holding the spring in place, twist and remove the adaptor. It's a trouble-free design that lets you "pull the plug" in mere seconds without any tools.



Four massive **ROTARY BOLT LUGS** provide support, strength and solid lockup in the receiver of the lightning-fast Super X[®] Pump shotgun. Under recoil, the mass of your body slows the rearward travel of the shotgun, while the inertial motion of the bolt, slide and forearm continue cycling the action to give you a head start ejecting the fired shell. Robust dual steel action guide bars eliminate the twisting and binding that waste time and energy when cycling the action.



DROP-OUT TRIGGER GROUP lets you remove one pin and pull the complete trigger system out for cleaning, lubrication and inspection. It's an easy way to keep your Super X[®] Pump shotgun in top shape, regardless of nasty weather or gritty shooting conditions.

The **CROSSBOLT SAFETY** button on the Super X[®] Pump shotgun is located on the front of the trigger guard for easy access, even when you're wearing heavy waterfowling gloves.



The Super X[®] Pump shotgun has the best recoil pad ever put on a synthetic stocked shotgun. Directional rib structures inside the **INFLEX TECHNOLOGY RECOIL PAD** help channel the recoil impulse by moving the comb down and away from your cheek. The pad's smooth textured surface makes shouldering the Super X Pump shotgun snag free regardless of what clothing you're wearing.



BLACK CHROME FINISH on the bolt, barrel, slide, action bars and other parts protects better than conventional bluing and stands up to years of wear and harsh conditions.

SUPER X[®] PUMP

THE FASTEST
PUMP IN
THE FIELD.

Take to the field with a perfectly balanced pump that offers instinctive pointability and absolute reliability — the Super X Pump Field shotgun. Now available in a new Compact model scaled for younger and smaller shooters, the Field is stocked in traditional hardwood and sports a vent rib barrel with 3" chamber and Invector-Plus™ choke tubes. If you're ready to drop your limit of birds in nothing flat, get behind a Super X Pump Field shotgun and put yourself ahead of the game.



	Item Number	Gauge	Barrel Length	Chamber	Magazine Capacity	Choke Tubes Included	Overall Length	Length of Pull	Drop at Comb	Drop at Heel	Nominal Wt. (lbs.)	Sugg. Retail
SXP[®] FIELD												
	512266391	12	26"	3"	4*	F, M, IC	46½"	14"	1½"	2"	6¾	\$399.99
	512266392	12	28"	3"	4*	F, M, IC	48½"	14"	1½"	2"	6¾	399.99
SXP[®] FIELD COMPACT												
NEW	512287390	12	24"	3"	4*	F, M, IC	43½"	13"	1½"	2"	6½	\$399.99
NEW	512271391	12	26"	3"	4*	F, M, IC	45½"	13"	1½"	2"	6½	399.99
NEW	512271392	12	28"	3"	4*	F, M, IC	47½"	13"	1½"	2"	6¾	399.99

*Total Capacity (Includes one shell in the chamber): Field: 2¾" = 5, 3" = 4

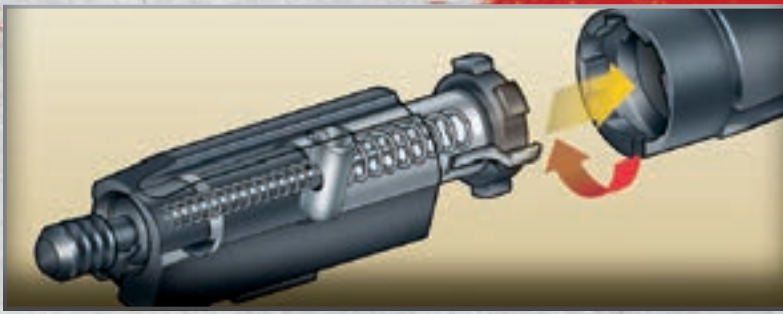

Four massive **ROTARY BOLT LUGS** provide support, strength and solid lockup in the receiver of the lightning-fast Super X® Pump shotgun. Under recoil, the mass of your body slows the rearward travel of the shotgun, while the inertial motion of the bolt, slide and forearm continue cycling the action to give you a head start ejecting the fired shell. Robust dual steel action guide bars eliminate the twisting and binding that waste time and energy when cycling the action.



FIELD

- **SATIN FINISHED STOCK AND FOREARM** with traditional checkering provides a sure grip when the hunting action gets hot
- **.742" BACK-BORED TECHNOLOGY** provides optimum shot patterns that are dense and even
- **3" CHAMBER** gives you the added range to knock down game with heavy hunting loads
- **INVECTOR-PLUS™ CHOKE TUBE SYSTEM** offers consistent patterns to match your situation
- **HARD CHROME CHAMBER AND BORE** make surfaces highly resistant to wear and corrosion
- **BLACK CHROME PROTECTION** on bolt and other components lasts longer than traditional bluing
- **BRASS FRONT SIGHT BEAD** offers a fast, natural sight picture
- **3-SHOT ADAPTOR WITH SPEED-PLUG SYSTEM** is easily removed without tools
- **DROP-OUT TRIGGER GROUP** allows easy cleaning
- **CROSSBOLT SAFETY** is easily operated
- **INFLEX TECHNOLOGY RECOIL PAD** directs felt recoil down and away from your cheek to reduce flinch and fatigue



NEW FIELD COMPACT

- **COMPACT 13" LENGTH OF PULL** is scaled down to fit younger and smaller-statured shooters
- **SATIN FINISHED STOCK AND FOREARM** with traditional checkering provides a sure grip when the hunting action gets hot
- **.742" BACK-BORED TECHNOLOGY** provides optimum shot patterns that are dense and even
- **3" CHAMBER** gives you the added range to knock down game with heavy hunting loads
- **INVECTOR-PLUS™ CHOKE TUBE SYSTEM** offers consistent patterns to match your situation
- **HARD CHROME CHAMBER AND BORE** make surfaces highly resistant to wear and corrosion
- **BLACK CHROME PROTECTION** on bolt and other components lasts longer than traditional bluing
- **BRASS FRONT SIGHT BEAD** offers a fast, natural sight picture
- **3-SHOT ADAPTOR WITH SPEED-PLUG SYSTEM** is easily removed without tools
- **DROP-OUT TRIGGER GROUP** allows easy cleaning
- **CROSSBOLT SAFETY** is easily operated, even by those with smaller fingers
- **INFLEX TECHNOLOGY RECOIL PAD** directs felt recoil down and away from your cheek to reduce flinch and fatigue, an especially important benefit for younger and novice shooters

SUPER X[®] PUMP

THE FASTEST
PUMP ON
THE POND.

If you're looking for a pump-action that's faster than a speeding greenhead, get the Super X Pump Waterfowl Hunter shotgun. No other pump-actuated system can match this shotgun's fast, dependable, inertia-assisted rotary bolt. This is the pump that can hammer out three shots in a mere half-second so you can fill your limit and be back in time to watch the big game. Pick up a Super X Pump Waterfowl Hunter shotgun, shoulder it, shoot it and you'll find it's got plenty of range, power and speed to spare.



SXP[®]

06

WINCHESTERGUNS.COM



HARD CHROME CHAMBER AND BORE are critical for today's steel or Hi-Density (HD) shot. This makes the surfaces highly resistant to wear and gives you superior protection from rust and corrosion. That's why all smoothbore Super X® Pump shotguns feature a hard-chromed chamber and bore.

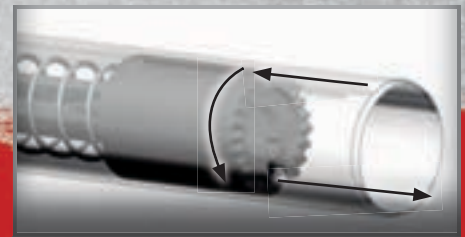

SPEED-PLUG SYSTEM lets you remove the three-shot adaptor with your fingers. Just remove the magazine cap, push on the spring retainer holding the spring in place and remove the adaptor. It's a trouble-free design that lets you "pull the plug" in mere seconds without any tools.

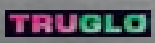
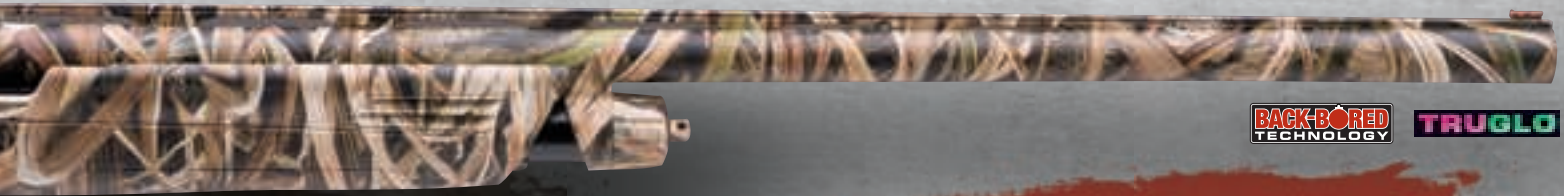

WATERFOWL HUNTER

- **SYNTHETIC STOCK WITH TEXTURED GRIPPING SURFACES** gives your hands a sure, non-slip grip and the non-glare Mossy Oak® Shadow Grass Blades finish won't spook wary waterfowl
- **.742" BACK-BORED TECHNOLOGY** provides optimum shot patterns that are dense and even
- **3½" CHAMBER** models give you the magnum advantage to reach out for long-range waterfowl
- **INVECTOR-PLUS™ CHOKE TUBE SYSTEM** offers consistent patterns to match your situation
- **HARD CHROME CHAMBER AND BORE** make these surfaces highly resistant to wear and corrosion
- **BLACK CHROME PROTECTION** on bolt and other components lasts longer than traditional bluing
- **TRUGLO® LONG BEAD™ FIBER-OPTIC FRONT SIGHT** offers a true, precise sight picture
- **3-SHOT ADAPTOR WITH SPEED-PLUG SYSTEM** is easily removed without tools
- **ROTARY BOLT** with four massive lugs provides strength, support and solid lockup
- **DROP-OUT TRIGGER GROUP** allows easy cleaning
- **CROSSBOLT SAFETY** is easily operated, even with gloves
- **INFLEX TECHNOLOGY RECOIL PAD** directs felt recoil down and away from your cheek to reduce flinch and fatigue

Item Number	Gauge	Barrel Length	Chamber	Magazine Capacity	Choke Tubes Included	Overall Length	Length of Pull	Drop at Comb	Drop at Heel	Nominal Wt. (lbs.)	Sugg. Retail
SXP® WATERFOWL HUNTER											
512270291	12	26"	3½"	4*	F, M, IC	47"	13¾"	1⅝"	2"	6⅞	\$499.99
512270292	12	28"	3½"	4*	F, M, IC	49"	13¾"	1⅝"	2"	7	499.99
512270391	12	26"	3"	4*	F, M, IC	46½"	13¾"	1⅝"	2"	6¾	459.99
512270392	12	28"	3"	4*	F, M, IC	48½"	13¾"	1⅝"	2"	6⅞	459.99

*Total Capacity (Includes one shell in the chamber): Waterfowl Hunter: 2¾" = 5, 3" = 4, 3½" = 4

SUPER X[®] PUMP BLACK MAGIC.

If you want a can-do pump to drop ducks, roll rabbits and smoke some clay targets, you need the super-fast, super-smooth Super X Pump Black Shadow[®] shotgun. If taking a trophy buck is on your to-do list, climb into your favorite tree stand with the Super X Pump Black Shadow Deer shotgun. Its 22" precision rifled barrel and fully adjustable sights will help you fill that empty space on your trophy room wall and put some great venison dinners on your family's table.



Item Number	Gauge	Barrel Length	Chamber	Magazine Capacity	Choke Tubes Included	Overall Length	Length of Pull	Drop at Comb	Drop at Heel	Nominal Wt. (lbs.)	Sugg. Retail
SXP[®] BLACK SHADOW											
512251291	12	26"	3½"	4*	F, M, IC	47"	13¾"	1½"	2"	6½	\$429.99
512251292	12	28"	3½"	4*	F, M, IC	49"	13¾"	1½"	2"	7	429.99
512251391	12	26"	3"	4*	F, M, IC	46½"	13¾"	1½"	2"	6¼	379.99
512251392	12	28"	3"	4*	F, M, IC	48½"	13¾"	1½"	2"	6½	379.99
SXP[®] BLACK SHADOW DEER											
512261340	12	22"	3"	4*	1:35" RH Twist	43"	13¾"	1½"	2"	6½	\$519.99

*Total Capacity (Includes one shell in the chamber) Black Shadow and Black Shadow Deer: 2¾" = 5, 3" = 4, 3½" = 4



BLACK SHADOW[®]

- **SYNTHETIC STOCK WITH TEXTURED GRIPPING SURFACES** gives your hands a sure, non-slip grip and the non-glare matte black finish won't spook wary game
- **.742" BACK-BORED TECHNOLOGY** provides optimum shot patterns that are dense and even
- **3½" CHAMBER** models give you the magnum advantage to reach out for long-range game
- **INVECTOR-PLUS™ CHOKE TUBE SYSTEM** offers consistent patterns to match your situation
- **HARD CHROME CHAMBER AND BORE** make these surfaces highly resistant to wear and corrosion
- **BLACK CHROME PROTECTION** on bolt and other components lasts longer than traditional bluing
- **BRASS FRONT SIGHT BEAD** offers a fast, natural sight picture
- **3-SHOT ADAPTOR WITH SPEED-PLUG SYSTEM** is easily removed without tools
- **ROTARY BOLT** with four massive lugs provides strength and solid lockup
- **DROP-OUT TRIGGER GROUP** allows easy cleaning
- **CROSSBOLT SAFETY** is easily operated, even with gloves
- **INFLEX TECHNOLOGY RECOIL PAD** directs felt recoil down and away from your cheek to reduce flinch and fatigue



F, M, IC

BLACK SHADOW[®] DEER

- **SYNTHETIC STOCK WITH TEXTURED GRIPPING SURFACES** gives your hands a sure, non-slip grip and the non-glare matte black finish won't spook wary game
- **22" FULLY-RIFLED BARREL** is designed to provide optimum accuracy with modern sabots and slugs
- **3" CHAMBER** gives you the ability to reach out for challenging shots
- **BLACK CHROME PROTECTION** on bolt and other components lasts longer than traditional bluing
- **TRUGLO[®] FIBER-OPTIC FRONT SIGHT AND ADJUSTABLE REAR SIGHT** offers a fast, natural sight picture
- **ALLOY RECEIVER** is drilled and tapped for scope bases
- **3-SHOT ADAPTOR WITH SPEED-PLUG SYSTEM** is easily removed without tools
- **ROTARY BOLT** with four massive lugs provides strength, support and solid lockup
- **DROP-OUT TRIGGER GROUP** allows easy cleaning
- **CROSSBOLT SAFETY** is easily operated, even with gloves
- **INFLEX TECHNOLOGY RECOIL PAD** directs felt recoil down and away from your cheek

SUPER X[®] PUMP **AGGRESSIVE DEFENSE.**

If your game is multi-gun competition or you want some heavy metal to protect your home and family, the Super X Pump Defender™ shotgun is the perfect choice. Its inertia-assisted action, six-shell total ammo capacity, durable composite stock and ribbed forearm give you a winning edge against any odds. The Super X Pump Marine Defender™ shotgun is built to resist the roughest weather, making it a perfect hard-duty gun on your boat, at your cabin or in your camp. Get a Super X Pump shotgun and own a faster blaster.



The receiver on both Winchester Super X[®] Pump Defender shotgun models is drilled and tapped for Winchester scope bases and rings. See the full line of bases and rings on page 59.



Item Number	Gauge	Barrel Length	Chamber	Magazine Capacity	Choke Tubes Included	Overall Length	Length of Pull	Drop at Comb	Drop at Heel	Nominal Wt. (lbs.)	Sugg. Retail
SXP[®] DEFENDER											
512252395	12	18"	3"	5*	N/A	38½"	13¾"	1⅜"	1⅝"	6¼	\$349.99
SXP[®] MARINE DEFENDER											
512268395	12	18"	3"	5*	CYL	38½"	13¾"	1⅜"	1⅝"	6¼	\$399.99

*Total Capacity (Includes one shell in the chamber): Defender and Marine Defender: 2¾" = 6, 3" = 5



DEFENDER™

- **SYNTHETIC STOCK WITH TEXTURED GRIPPING SURFACES** gives your hands a sure, non-slip grip and the non-glare matte black finish won't give you away
- **TACTICAL RIBBED FOREARM** for better control when you need it most
- **HARD CHROMED CHAMBER AND BORE** make these surfaces highly resistant to wear and corrosion
- **FIXED CYLINDER CHOKE** barrel handles both slugs and buckshot
- **ALLOY RECEIVER** is drilled and tapped for scope bases
- **TRADITIONAL BRASS BEAD FRONT SIGHT** offers a fast, natural sight picture
- **ROTARY BOLT** with four massive lugs provides strength and solid lockup
- **DROP-OUT TRIGGER GROUP** allows easy cleaning
- **CROSSBOLT SAFETY** is easily operated, even with gloves
- **BLACK CHROME PROTECTION** on bolt and other components lasts longer than traditional bluing
- **INFLEX TECHNOLOGY RECOIL PAD** directs felt recoil down and away from your cheek to reduce flinch and fatigue



MARINE DEFENDER™

- **MATTE HARD CHROME PLATING** on barrel and magazine tube for the ultimate protection against wear and the elements
- **ALLOY RECEIVER** is drilled and tapped for scope bases
- **SYNTHETIC STOCK WITH TEXTURED GRIPPING SURFACES** gives your hands a sure, non-slip grip and the non-glare matte black finish won't give you away
- **TACTICAL RIBBED FOREARM** for better control when you need it most
- **HARD CHROMED CHAMBER AND BORE** make these surfaces highly resistant to wear and corrosion
- **TRADITIONAL BRASS BEAD FRONT SIGHT** plus a removable TruGlo® fiber-optic front offers a fast, natural sight picture
- **INVECTOR-PLUS™ CHOKE TUBE SYSTEM** with cylinder choke installed works with slugs or buckshot
- **ROTARY BOLT** with four massive lugs provides strength and solid lockup
- **DROP-OUT TRIGGER GROUP** allows easy cleaning
- **CROSSBOLT SAFETY** is easily operated, even with gloves
- **INFLEX TECHNOLOGY RECOIL PAD** directs felt recoil down and away from your cheek to reduce flinch and fatigue

CYL



SUPER X[®] PUMP

**SPEED
FOR LONG
BEARDS.**

Turn that strutting old tom into your Thanksgiving dinner with the fastest 3½" pump on the planet! The Super X Pump Turkey Hunter shotgun offers full coverage camo, instant pointability, adjustable fiber-optic sights, an extra-full choke tube and a heavy magnum-class punch that's essential for putting wild turkeys on a platter. Follow-up shots come with autoloader-class speed because of the Super X Pump shotgun's inertia-assisted slide action, capable of pounding out three shots in a mere half-second. The Inflex Technology recoil pad moves recoil down and away from your cheek to help ease the thump of today's heavy turkey loads. You'll never be under-gunned while that trophy tom is out strutting his stuff when you're carrying the Super X Pump Turkey Hunter shotgun.



SXP[®]

12 WINCHESTERGUNS.COM



TURKEY HUNTER

- **SYNTHETIC STOCK WITH TEXTURED GRIPPING SURFACES** gives your hands a sure, non-slip grip and the Mossy Oak® Break-Up Infinity® non-glare finish won't spook wary birds
- **.742" BACK-BORED TECHNOLOGY** provides optimum shot patterns that are dense and even
- **3½" CHAMBER** gives you the magnum advantage to reach out for long-range turkeys
- **INVECTOR-PLUS™ EXTRA-FULL TURKEY CHOKE TUBE** for a tight, dense pattern
- **HARD CHROMED CHAMBER AND BORE** make these surfaces highly resistant to wear and corrosion
- **ALLOY RECEIVER** is drilled and tapped for scope bases
- **TRUGLO® FIBER-OPTIC ADJUSTABLE SIGHTS** offer a fast, natural sight picture
- **ROTARY BOLT** with four massive lugs provides strength and solid lockup
- **DROP-OUT TRIGGER GROUP** allows easy cleaning
- **CROSSBOLT SAFETY** is easily operated, even with gloves
- **BLACK CHROME PROTECTION** on bolt and other components lasts longer than traditional bluing
- **INFLEX TECHNOLOGY RECOIL PAD** directs felt recoil down and away from your cheek to reduce flinch and fatigue

Item Number	Gauge	Barrel Length	Chamber	Magazine Capacity	Choke Tubes Included	Overall Length	Length of Pull	Drop at Comb	Drop at Heel	Nominal Wt. (lbs.)	Sugg. Retail
SXP® TURKEY HUNTER											
512259290	12	24"	3½"	4*	T	45"	13¾"	1⅝"	2"	6½	\$519.99
*Total Capacity (Includes one shell in the chamber): Turkey Hunter: 2¾" = 5, 3" = 4, 3½" = 4											

SUPER X[®]3 SO JUST HOW FAST IS SUPER X3 FAST?

How about a blazing 12 shots in a mere 1.442 seconds? That's Winchester[®] Super X3 shotgun fast! As impressive as raw cycling speed is, it doesn't put more birds in your boat or get your name at the top of the scoreboard unless it's coupled with precise control. That's why the Super X3 shotgun is designed to fit naturally with a fluid, balanced swing that becomes a perfect extension of your body. The adjustable stock will contribute to a more accurate aim and the softer felt recoil provided by the Inflex Technology recoil pad keeps you shooting all day long. And when you're finished firing a few boxes of shells, you'll really appreciate how this slick-shooting gas-operated autoloader keeps itself cleaner than the competition. You're running first in the fast lane with the Super X3 shotgun.

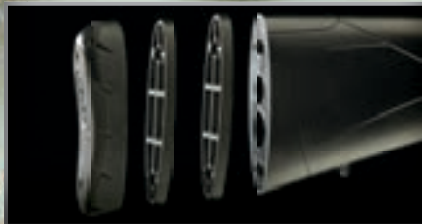
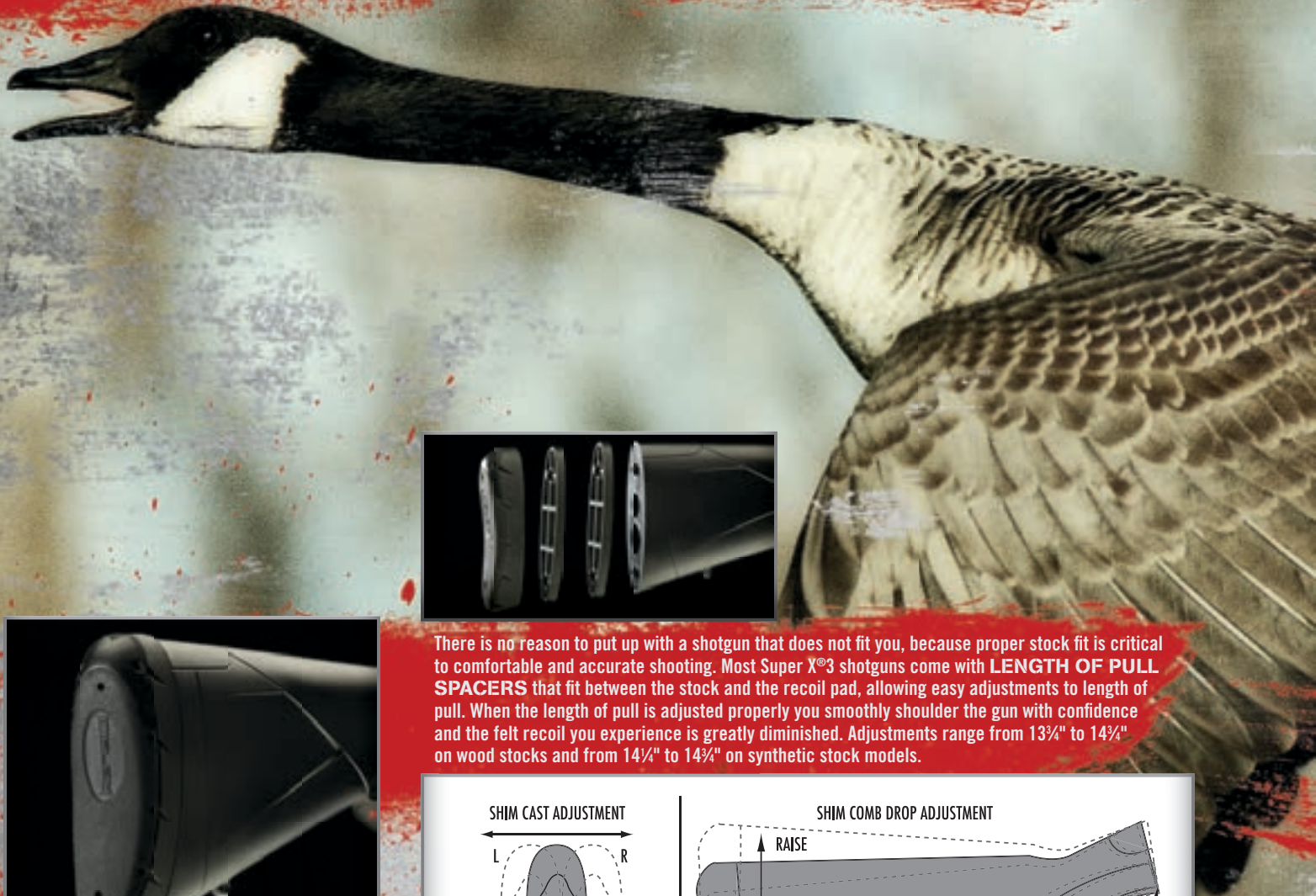

There is no reason to put up with a shotgun that does not fit you, because proper stock fit is critical to comfortable and accurate shooting. Most Super X[®]3 shotguns come with **LENGTH OF PULL SPACERS** that fit between the stock and the recoil pad, allowing easy adjustments to length of pull. When the length of pull is adjusted properly you smoothly shoulder the gun with confidence and the felt recoil you experience is greatly diminished. Adjustments range from 13³/₄" to 14³/₄" on wood stocks and from 14¹/₄" to 14³/₄" on synthetic stock models.

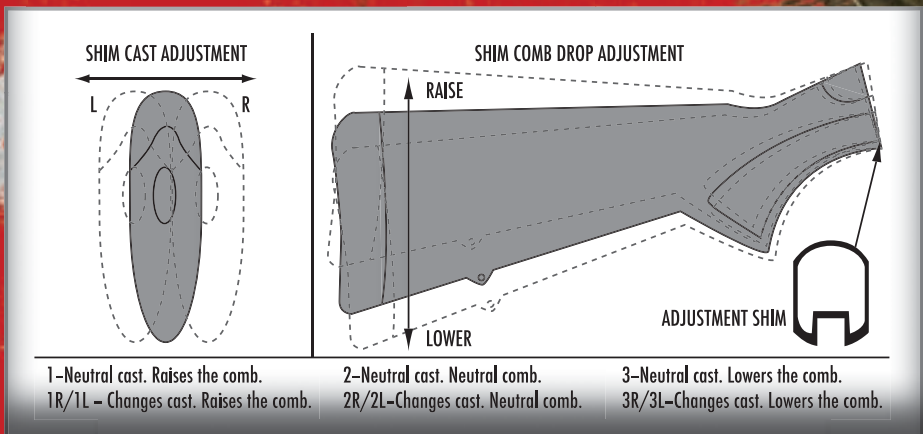

Getting pounded by your gun's recoil is a thing of the past with the **INFLEX TECHNOLOGY RECOIL PAD**. Specially shaped rib structures located inside the pad help direct and channel the recoil impulse, moving the comb down and away from your cheek to reduce felt recoil to very manageable levels, even when shooting heavy magnum loads. A hard heel insert on the pad makes mounting the Super X[®]3 shotgun snag-free.

Every shooter is different, and no single stock design will perfectly fit every person. **CAST/DROP SHIMS** on Super X[®]3 shotgun synthetic stock models allow you to easily adjust both cast on/cast off and drop at comb over a 1/4" range simply by inserting one of the six special shims between the receiver and the buttstock.

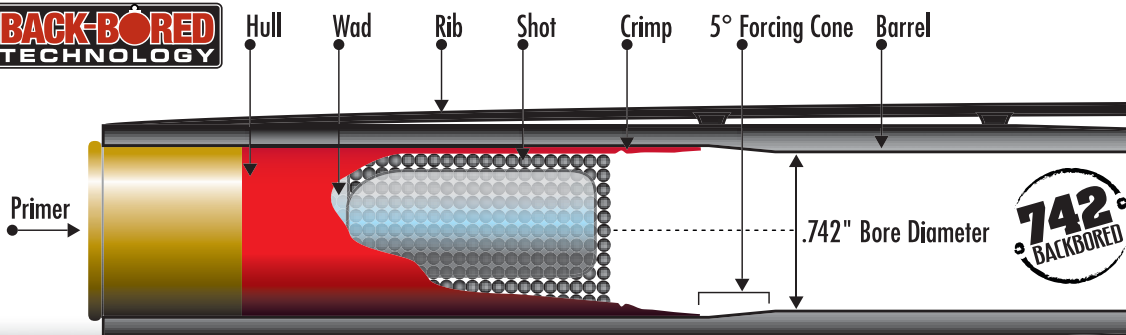

.742" BACK-BORED TECHNOLOGY is based on extensive research and testing. .742" is the ideal 12 gauge interior barrel diameter, ensuring uniform, consistent patterns. Any larger and gases blow by the shot cup and reduce pellet velocity. Too tight and the pellets are deformed as they pass through the forcing cone, causing poor ballistic performance.



HARD CHROME CHAMBER AND BORE are critical for today's steel or Hi-Density (HD) shot. Hard chrome makes the surfaces highly resistant to wear and gives you superior protection from rust and corrosion. That's why all smoothbore Super X[®]3 shotguns feature a hard-chromed chamber and bore.



LOAD DIVERSITY means a Super X[®]3 shotgun can reliably shoot them all, from light factory target shells to heavy magnum waterfowl and turkey loads. That's why the Super X[®]3 shotgun has been proven as the most versatile autoloader on the range, in the marsh and in the field.



From the duck blind to the firing line, the **INVECTOR-PLUS™ CHOKE TUBE SYSTEM** is the world's most consistent. The Super X[®]3 shotgun comes with either extended Signature or flush-mounted tubes, depending on the model. Additional tubes are available at your local Winchester Repeating Arms dealer.



The **ACTIVE VALVE SYSTEM** automatically self-adjusts to allocate the exact gas pressure necessary to reliably cycle a wide range of loads commonly used for hunting or target shooting. When firing the heaviest magnum loads in 3½" models, gases vent upward and a portion of them are vented forward out the Quadra-Vent™ ports in the forearm to help regulate bolt speed. Both 3" and 3½" Super X[®]3 shotguns will reliably cycle even 1½ oz., 2¾" light target loads.



Excess gases from heavy loads are channeled through the forward **QUADRA-VENT™** ports for cleaner and more reliable operation.

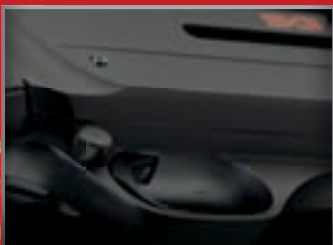

The **AMBIDEXTROUS SAFETY** button on the Super X[®]3 shotgun is located at the rear of the trigger guard and is easily reversible for both right- or left-handed shooters.



The **DROP-OUT TRIGGER GROUP** is easy to remove for cleaning or lubrication.

RNT-V

Winchester Repeating Arms is a **PROUD SPONSOR** of the television show RNT-V. If you want to stay on top of your game in expert waterfowl calling and shooting, tune in for timely tactics. Check your local listings for broadcast dates and times.

WANNA SEE FAST?
Scan this ▶



SUPER X[®]3 HEAVY SMOKER.

The Winchester[®] Super X3 Sporting shotgun gives you extraordinary cycling speed for faster follow-up shots to make smoke out of elusive clay targets. The svelte Super X3 Sporting shotgun tips the scales at a shade over 7 pounds to help create a well-balanced, more controlled swing. The adjustable comb lets you custom fit your eye-to-rib alignment to perfectly match your personal shooting style. The Super X3 Sporting shotgun is designed from the ground up to incorporate all the features that put you right on target every time you step into the shooting station.



SX3[®]

Item Number	Gauge	Barrel Length	Chamber	Magazine Capacity	Choke Tubes Included	Overall Length	Length of Pull	Drop at Comb	Drop at Heel	Nominal Wt. (lbs.)	Sugg. Retail
SX3[®] SPORTING (ADJUSTABLE COMB)											
511115392	12	28"	2¾"	4*	LF, IM, M, IC, SK	49¼"	14½"	1½"†	1¾"†	7¾	\$1,699.99
511115393	12	30"	2¾"	4*	LF, IM, M, IC, SK	51¼"	14½"	1½"†	1¾"†	7½	1,699.99
511115394	12	32"	2¾"	4*	LF, IM, M, IC, SK	53¼"	14½"	1½"†	1¾"†	7½	1,699.99

*Total Capacity (Includes one shell in the chamber) Sporting: 2¾" = 5 †Adjustable comb stock dimensions are measured with comb in the lowest position.

12 SHOTS IN
1.442
SECONDS



The Super X®3 Sporting shotgun comes with a durable, fitted ABS hard case embossed with the Winchester® logo.

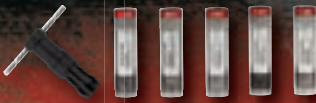

T-Wrench, LF, IM, M, IC, SK

SPORTING

- **SATIN OIL FINISH GRADE II / III WALNUT STOCK WITH CUT CHECKERING** improves grip and looks elegant
- **FULLY ADJUSTABLE COMB** allows you to custom fit the stock to perfectly align your head position
- **NICKEL-PLATED BOLT, CARRIER, SLIDE AND COCKING HANDLE** are extremely durable and easy to keep clean
- **.742" BACK-BORED TECHNOLOGY** provides optimum shot patterns that are dense and even
- **2¾" CHROME PLATED CHAMBER AND BORE** make these surfaces highly resistant to wear and corrosion
- **TRUGLO® TRU-BEAD™ FIBER-OPTIC FRONT SIGHT** with interchangeable light pipes and white mid-bead offers a true, precise sight picture in any light
- **PORTED BARREL** reduces muzzle jump and helps tame felt recoil
- **EXTENDED SIGNATURE INVECTOR-PLUS™ CHOKE TUBE SYSTEM** offers consistent patterns to match your situation
- **CUSTOM ACTIVE VALVE SYSTEM DESIGNED FOR THE SUPER X®3 SPORTING SHOTGUN** cycles standard target loads to the heaviest 2¾" loads while reducing felt recoil
- **PACHMAYR® DECELERATOR® RECOIL PAD** provides optimal protection against felt recoil
- **AMBIDEXTROUS CROSSBOLT SAFETY** is easily reversible
- **DROP-OUT TRIGGER GROUP** allows easy cleaning

SUPER X[®]3 FULL SPEED AFIELD.

The traditional look of finely-figured walnut is right at home on the Super X3 Field shotgun. With trim lines, crisp cut checkering and a premium recoil pad, the Super X3 shotgun is much more than a pretty face — it shoots like greased lightning. Smaller-statured hunters should go afield with the Super X3 Field Compact shotgun. It has all the features of the full-size model plus a shorter 13" length of pull stock to perfectly fit those with smaller builds. The Super X3 shotgun — still the fastest afield.



12 SHOTS IN
1.442
SECONDS

SX3[®]



	Item Number	Gauge	Barrel Length	Chamber	Magazine Capacity	Choke Tubes Included	Overall Length	Length of Pull	Drop at Comb	Drop at Heel	Nominal Wt. (lbs.)	Sugg. Retail
SX3[®] FIELD												
	511144391	12	26"	3"	4*	F, M, IC	46 ³ / ₄ "	14"	1 ¹ / ₂ "	1 ³ / ₄ "	6 ³ / ₄	\$1,069.99
	511144392	12	28"	3"	4*	F, M, IC	48 ³ / ₄ "	14"	1 ¹ / ₂ "	1 ³ / ₄ "	6 ⁷ / ₈	1,069.99
	511144691	20	26"	3"	4*	F, M, IC	46 ³ / ₄ "	14"	1 ⁵ / ₈ "	1 ⁷ / ₈ "	6 ⁵ / ₈	1,069.99
	511144692	20	28"	3"	4*	F, M, IC	48 ³ / ₄ "	14"	1 ⁵ / ₈ "	1 ⁷ / ₈ "	6 ¹ / ₂	1,069.99
SX3[®] FIELD COMPACT												
NEW	511146390	12	24"	3"	4*	F, M, IC	43 ³ / ₄ "	13"	1 ¹ / ₂ "	1 ³ / ₄ "	6 ⁵ / ₈	\$1,069.99
	511146391	12	26"	3"	4*	F, M, IC	45 ³ / ₄ "	13"	1 ¹ / ₂ "	1 ³ / ₄ "	6 ³ / ₄	1,069.99
	511146392	12	28"	3"	4*	F, M, IC	47 ³ / ₄ "	13"	1 ¹ / ₂ "	1 ³ / ₄ "	6 ⁷ / ₈	1,069.99
NEW	511146690	20	24"	3"	4*	F, M, IC	43 ³ / ₄ "	13"	1 ⁵ / ₈ "	1 ⁷ / ₈ "	6 ³ / ₄	1,069.99
	511146691	20	26"	3"	4*	F, M, IC	45 ³ / ₄ "	13"	1 ⁵ / ₈ "	1 ⁷ / ₈ "	6 ⁵ / ₈	1,069.99
	511146692	20	28"	3"	4*	F, M, IC	47 ³ / ₄ "	13"	1 ⁵ / ₈ "	1 ⁷ / ₈ "	6 ¹ / ₂	1,069.99

*Total Capacity (Includes one shell in the chamber): Field and Field Compact: 2³/₄" = 5, 3" = 4

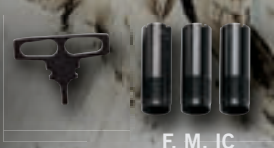

FIELD

- **SATIN OIL FINISH WALNUT STOCK WITH CLASSIC CUT CHECKERING** improves grip and looks elegant
- **MATTE BLACK RECEIVER** is strong, lightweight aluminum alloy to reduce weight for easy carrying
- **.742" BACK-BORED TECHNOLOGY** provides optimum shot patterns that are dense and even
- **VENT RIB** gives you a smooth, clean sighting plane and helps reduce weight
- **BRASS FRONT SIGHT BEAD** offers a fast, natural sight picture
- **3" CHROME PLATED CHAMBER AND BORE** make these surfaces highly resistant to wear and corrosion
- **INVECTOR-PLUS™ CHOKE TUBES** offer consistent, reliable patterns
- **ACTIVE VALVE SYSTEM** cycles a wide variety of loads while reducing felt recoil
- **PACHMAYR® DECELERATOR® RECOIL PAD** provides optimal protection against felt recoil
- **AMBIDEXTROUS CROSSBOLT SAFETY** is easily reversible
- **DROP-OUT TRIGGER GROUP** allows easy cleaning



FIELD COMPACT

- **COMPACT 13" LENGTH OF PULL** to fit smaller statured shooters
- **SATIN OIL FINISH WALNUT STOCK WITH CLASSIC CUT CHECKERING** improves grip and looks elegant
- **MATTE BLACK RECEIVER** is strong, lightweight aluminum alloy to reduce weight for easy carrying
- **.742" BACK-BORED TECHNOLOGY** provides optimum shot patterns that are dense and even
- **VENT RIB** gives you a smooth, clean sighting plane and helps reduce weight
- **BRASS FRONT SIGHT BEAD** offers a fast, natural sight picture
- **3" CHROME PLATED CHAMBER AND BORE** make these surfaces highly resistant to wear and corrosion
- **INVECTOR-PLUS™ CHOKE TUBES** offer consistent, reliable patterns
- **ACTIVE VALVE SYSTEM** cycles a wide variety of loads while reducing felt recoil
- **PACHMAYR® DECELERATOR® RECOIL PAD** provides optimal protection against felt recoil
- **AMBIDEXTROUS CROSSBOLT SAFETY** is easily reversible
- **DROP-OUT TRIGGER GROUP** allows easy cleaning

SUPER X[®]3 SPEED DEMONS.

Along with demon-like speed, the Super X3 Black Shadow[®] shotgun looks absolutely awesome with a tough matte black synthetic stock that is ready to take on drifting snow, rain squalls, marsh mud and blowing dust. Deer hunters using modern slugs will love the Cantilever Buck shotgun. Its barrel-mounted cantilever optics rail lets you remove the barrel without fear of losing the zero on your conventional scope or electronic red dot sight. If you prefer using the adjustable TRUGLO[®] fiber-optic open sights they'll put you right on your target in a snap.

RNT-V

"As hunters, we live by the whims of Mother Nature; there are no absolutes. As a duck hunter, I rely on the things I can control such as lifelike decoys, a good duck call, a warm pair of waders, shells and a trusty shotgun. I know that when it's time to get things done, every time I punch the safety and pull the trigger, my Super X[®]3 shotgun is gonna work."

— JIM RONQUEST
 Producer RNT-V
 World Champion Duck Caller
 Co-Host of RNT-V

12 SHOTS IN
1.442
 SECONDS

Item Number	Gauge	Barrel Length	Chamber	Magazine Capacity	Choke Tubes Included	Overall Length	Length of Pull	Drop at Comb	Drop at Heel	Nominal Wt. (lbs.)	Sugg. Retail
SX3[®] BLACK SHADOW											
511123291	12	26"	3½"	4*	F, M, IC	47"	14¼"	1¾"	2"	7	\$1,069.99
511123292	12	28"	3½"	4*	F, M, IC	49"	14¼"	1¾"	2"	7¼	1,069.99
511123391	12	26"	3"	4*	F, M, IC	47"	14¼"	1¾"	2"	7	999.99
511123392	12	28"	3"	4*	F, M, IC	49"	14¼"	1¾"	2"	7¼	999.99
511123691	20	26"	3"	4*	F, M, IC	47"	14¼"	1¾"	2"	6½	999.99
511123692	20	28"	3"	4*	F, M, IC	49"	14¼"	1¾"	2"	6¾	999.99
SX3[®] CANTILEVER BUCK											
511147340	12	22"	3"	4†	1:28" RH Twist	43"	14¼"	1¾"	2"	7¼	\$1,149.99
511147640	20	22"	3"	4†	1:24" RH Twist	43"	14¼"	1¾"	2"	7½	1,149.99

*Total Capacity (Includes one shell in the chamber): Black Shadow and Cantilever Buck: 2¾" = 5, 3" = 4, 3½" = 4 †Magazine capacity depends on shell length. Some slugs are longer than standard 2¾" shot shells.

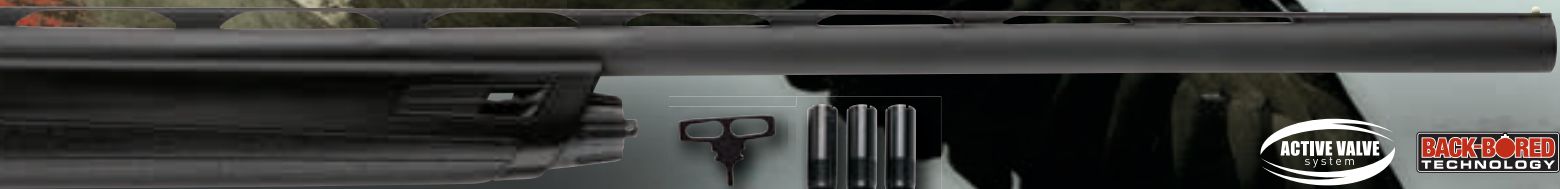

BLACK SHADOW®

- **SYNTHETIC STOCK WITH TEXTURED GRIPPING SURFACES** gives your hands a sure, non-slip grip and the non-glare matte black finish won't spook wary game
- **.742" BACK-BORED TECHNOLOGY** provides optimum shot patterns that are dense and even
- **INVECTOR-PLUS™ CHOKE TUBE SYSTEM** offers consistent patterns to match your situation
- **HARD CHROME CHAMBER AND BORE** make these surfaces highly resistant to wear and corrosion
- **BRASS BEAD FRONT SIGHT** offers a fast, natural sight picture
- **SELF-ADJUSTING ACTIVE VALVE SYSTEM** cycles a wide variety of loads while reducing felt recoil
- **QUADRA-VENT™ PORTS** vent excess gases for cleaner operation
- **DROP-OUT TRIGGER GROUP** allows easy cleaning
- **AMBIDEXTROUS CROSSBOLT SAFETY** is easily reversible
- **CAST/DROP SHIMS AND LENGTH OF PULL SPACERS** allow adjustments for a perfect fit
- **INFLEX TECHNOLOGY RECOIL PAD** directs felt recoil down and away from your cheek to reduce flinch and fatigue

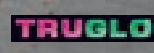

CANTILEVER BUCK

- **SYNTHETIC STOCK WITH TEXTURED GRIPPING SURFACES** gives your hands a sure, non-slip grip and the non-glare matte black finish won't spook wary game
- **RIFLED 22" BARREL** optimized for extreme accuracy with 2¾" and 3" sabots and slugs
- **MATTE BLACK RECEIVER** is strong, lightweight aluminum alloy for easy carrying
- **WEAVER® STYLE CANTILEVER RAIL DESIGN** makes it easy to attach an electronic sight or conventional scope
- **TRUGLO® FIBER-OPTIC FRONT SIGHT** with adjustable rear sight gathers light for fast, quick pointing
- **SELF-ADJUSTING ACTIVE VALVE SYSTEM** cycles a wide variety of loads while reducing felt recoil
- **DROP-OUT TRIGGER GROUP** allows easy cleaning
- **AMBIDEXTROUS CROSSBOLT SAFETY** is easily reversible
- **CAST/DROP SHIMS AND LENGTH OF PULL SPACERS** allow adjustments for a perfect fit
- **INFLEX TECHNOLOGY RECOIL PAD** directs felt recoil down and away from your cheek to reduce flinch and fatigue



SUPER X[®]3 WELL-HIDDEN HUNTERS.

Conceal yourself from wary game with a stealthy Super X3 shotgun. Both of these camo-clad speed machines come in 12 and 20 gauge models to perfectly match your quarry and environment. The Super X3 Waterfowl Hunter shotgun in Mossy Oak[®] Shadow Grass Blades blends right in with your blind or marsh to fool wary ducks and geese. The Universal Hunter shotgun in Mossy Oak[®] Break-Up Infinity[®] camo helps you disappear from ducks, deer, wild hogs and turkeys in flooded timber or the woods. It's also drilled and tapped for scope mounts.

RNT-V

"Born and raised duck hunting in Stuttgart, Arkansas along with traveling around the country gathering footage for RNT-V, I have had the opportunity to shoot several different shotguns. For me, the Winchester Super X[®]3 shotgun is hands down the best fitting, best handling, most reliable gun I have ever shot. The Super X3 shotgun has done everything I have ever asked it to do — every time I pull the trigger."

— JOHN STEPHENS
President RNT Calls
3-time World Champion Duck Caller
Executive Producer and Co-Host of RNT-V

	Item Number	Gauge	Barrel Length	Chamber	Magazine Capacity	Choke Tubes Included	Overall Length	Length of Pull	Drop at Comb	Drop at Heel	Nominal Wt. (lbs.)	Sugg. Retail
SX[®]3 WATERFOWL HUNTER												
	511155291	12	26"	3½"	4*	F, M, IC	47"	14¼"	1¼"	2"	7	\$1,199.99
	511155292	12	28"	3½"	4*	F, M, IC	49"	14¼"	1¼"	2"	7½	1,199.99
	511155391	12	26"	3"	4*	F, M, IC	47"	14¼"	1¼"	2"	7	1,139.99
	511155392	12	28"	3"	4*	F, M, IC	49"	14¼"	1¼"	2"	7½	1,139.99
	511155691	20	26"	3"	4*	F, M, IC	47"	14¼"	1¼"	2"	6½	1,139.99
	511155692	20	28"	3"	4*	F, M, IC	49"	14¼"	1¼"	2"	6¾	1,139.99
SX[®]3 UNIVERSAL HUNTER												
	511148291	12	26"	3½"	4*	F, M, IC	47"	14¼"	1¼"	2"	7	\$1,229.99
	511148292	12	28"	3½"	4*	F, M, IC	49"	14¼"	1¼"	2"	7½	1,229.99
	511148691	20	26"	3"	4*	F, M, IC	47"	14¼"	1¼"	2"	6½	1,159.99
	511148692	20	28"	3"	4*	F, M, IC	49"	14¼"	1¼"	2"	6¾	1,159.99

*Total Capacity (Includes one shell in the chamber): Waterfowl Hunter and Universal Hunter: 2¾" = 5, 3" = 4, 3½" = 4

12 SHOTS IN
1.442
SECONDS

22

WINCHESTERGUNS.COM



F, M, IC

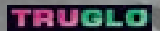

WATERFOWL HUNTER

- **SYNTHETIC STOCK WITH TEXTURED GRIPPING SURFACES** gives your hands a sure, non-slip grip and the non-glare Mossy Oak® Shadow Grass Blades finish won't spook wary waterfowl
- **.742" BACK-BORED TECHNOLOGY** provides optimum shot patterns that are dense and even
- **INVECTOR-PLUS™ CHOKE TUBE SYSTEM** offers consistent patterns to match your situation
- **HARD CHROME CHAMBER AND BORE** make these surfaces highly resistant to corrosion and wear from steel shot
- **VENT RIB** gives you a smooth, clean sighting plane
- **TRUGLO® LONG BEAD™ FIBER-OPTIC FRONT SIGHT** offers true, precise sight picture
- **ACTIVE VALVE GAS SYSTEM** cycles a wide variety of loads while reducing felt recoil
- **QUADRA-VENT™ PORTS** vent excess gases for cleaner operation
- **DROP-OUT TRIGGER GROUP** allows easy cleaning
- **AMBIDEXTROUS CROSSBOLT SAFETY** is easily reversible
- **CAST/DROP SHIMS AND LENGTH OF PULL SPACERS** allow adjustments for perfect fit
- **INFLEX TECHNOLOGY RECOIL PAD** directs felt recoil down and away from your cheek to reduce flinch and fatigue



F, M, IC

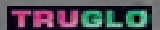

UNIVERSAL HUNTER

- **SYNTHETIC STOCK WITH TEXTURED GRIPPING SURFACES** gives your hands a sure, non-slip grip and the non-glare Mossy Oak® Break-Up Infinity® finish won't spook wary game
- **.742" BACK-BORED TECHNOLOGY** provides optimum shot patterns that are dense and even
- **INVECTOR-PLUS™ CHOKE TUBE SYSTEM** offers consistent patterns to match your situation
- **HARD CHROME CHAMBER AND BORE** make these surfaces highly resistant to wear and corrosion
- **VENT RIB** gives you a smooth, clean sighting plane
- **TRUGLO® LONG BEAD™ FIBER-OPTIC FRONT SIGHT** offers true, precise sight picture
- **ACTIVE VALVE GAS SYSTEM** cycles a wide variety of loads while reducing felt recoil
- **QUADRA-VENT™ PORTS** vent excess gases for cleaner operation
- **DROP-OUT TRIGGER GROUP** allows easy cleaning
- **AMBIDEXTROUS CROSSBOLT SAFETY** is easily reversible
- **CAST/DROP SHIMS AND LENGTH OF PULL SPACERS** allow adjustments for perfect fit
- **DRILLED AND TAPPED RECEIVER** for mounting your favorite scope
- **INFLEX TECHNOLOGY RECOIL PAD** directs felt recoil down and away from your cheek to reduce flinch and fatigue



SUPER X[®]3 EARN YOUR SPURS.

Here's the shotgun specifically designed to bust a trophy tom right in the middle of his strut. The Winchester[®] Super X3 NWTF[®] Cantilever Turkey shotgun in 12 gauge features a 24" barrel with a 3½" chamber (3" chamber in 20 gauge), a cantilever scope base and fully-adjustable TRUGLO[®] fiber-optic sights. You can tame the felt recoil from heavy turkey loads with the hyper-reliable Active Valve gas system. The Invector-Plus[™] Extra-Full Turkey choke tube funnels all those pellets in a tight pattern to really drop the hammer on your trophy. Don't trust some inferior shotgun to make it all happen as you hunt the largest and smartest game bird in the woods. Bust your bird and earn your spurs with the Super X3 NWTF Cantilever Turkey shotgun — the fastest gun ever to stop a strutter.

SX3

EXTRA-FULL TURKEY CHOKE TUBE
A tight, dense pattern of heavy shot is critical for taking turkeys. You get an Invector-Plus[™] Extra-Full Turkey choke tube standard with the Super X[®]3 NWTF[®] Cantilever Turkey shotgun. The knurled band makes it easy to install or remove and the camo band won't give you away to a sharp-eyed tom.



12 SHOTS IN
1.442
SECONDS

24 WINCHESTERGUNS.COM



NWTF[®] CANTILEVER TURKEY

- **SYNTHETIC STOCK WITH TEXTURED GRIPPING SURFACES** gives your hands a sure, non-slip grip and the non-glare Mossy Oak[®] Break-Up Infinity[®] finish won't spook wary turkeys
- **.742" BACK-BORED TECHNOLOGY** provides optimum shot patterns that are dense and even
- **INVECTOR-PLUS[™] EXTRA-FULL TURKEY CHOKE TUBE** with Mossy Oak Break-Up Infinity band produces a tight, tom-busting pattern
- **24" BARREL** is easy to swing in tight brush
- **TRUGLO[®] FIBER-OPTIC FRONT SIGHT WITH ADJUSTABLE REAR SIGHT** gathers light for fast, quick pointing
- **WEAVER[®] STYLE CANTILEVER RAIL DESIGN** makes it easy to attach an electronic sight or conventional scope
- **QUADRA-VENT[™] PORTS** vent excess gases for cleaner operation
- **DROP-OUT TRIGGER GROUP** allows easy cleaning
- **AMBIDEXTROUS CROSSBOLT SAFETY** is easily reversible
- **CAST/DROP SHIMS AND LENGTH OF PULL SPACERS** allow adjustments for perfect fit
- **INFLEX TECHNOLOGY RECOIL PAD** directs felt recoil down and away from your cheek to reduce flinch and fatigue

Item Number	Gauge	Barrel Length	Chamber	Magazine Capacity	Choke Tubes Included	Overall Length	Length of Pull	Drop at Comb	Drop at Heel	Nominal Wt. (lbs.)	Sugg. Retail
SX3[®] NWTF CANTILEVER TURKEY											
511149290	12	24"	3½"	4*	T	45"	14¼"	1¼"	2"	7½	\$1,199.99
511149690	20	24"	3"	4*	T	45"	14¼"	1¼"	2"	7½	1,139.99

*Total Capacity (Includes one shell in the chamber): NWTF Cantilever Turkey: 2¼" = 5, 3" = 4, 3½" = 4

MODEL 101[®] ELEGANT PERFORMANCE.

The apex of shotgun elegance has always been typified by a Belgian-made over and under. These artful guns are a living tribute to Old World craftsmanship as expressed in engraved steel and checkered walnut. Alas, such artistry always comes at a price — with the Model 101 shotgun it's an attractive value few others can match. The low-profile steel receiver and mild recoil make the Model 101 shotgun extremely pleasant to shoot all day. This is a robust action that has been tested by firing 25,000 shells without a single part failure so you know it's built to last. When you shoulder the Model 101 shotgun at your Winchester Repeating Arms dealer, you'll realize you've finally found the perfect over and under. In addition, its reasonable price tag will put a smile on your face.



Today's Model 101[®] shotgun features the same **FAMILIAR DIMENSIONS** set long ago by the original. The familiar drop at comb and narrow, comfortable grip ensure time-tested comfort and performance.



The Model 101[®] shotgun has the drop on the original with the advantage of a **LOW-PROFILE RECEIVER**. This means that recoil occurs in-line, directly back for faster follow-up shots with less muzzle jump. Also, your forward hand can be closer to the bore centerline, bringing your hands, face and sighting plane into a more natural alignment for more intuitive and accurate shooting.



An **ADJUSTABLE COMB** stock allows you to modify individual height and cast on/off for a custom fit in just seconds. (Hex wrench is included.)

Every Model 101[®] shotgun has **FINELY CUT CHECKERING** to improve grip and add artistic elegance to the well-figured walnut stock and forearm.



An **ADJUSTABLE TRIGGER SHOE** lets you fine tune its fore and aft position to your precise length of pull for more comfortable shooting on Pigeon and Sporting models. (Hex wrench is included.)



Getting pounded by recoil is now a thing of the past with the patented **PACHMAYR[®] DECELERATOR[®] RECOIL PAD** with snag-free heel. Found on all Model 101[®] shotguns, it reduces felt recoil to very manageable levels, even when shooting heavy magnum loads.



Sporting and Field models have a fitted **STEEL GRIP CAP** to add a touch of graceful elegance.

**BACK-BORED
TECHNOLOGY**

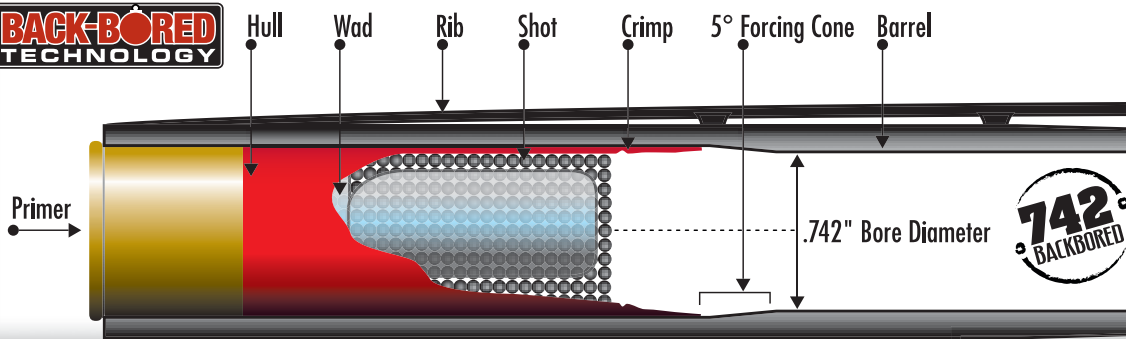

.742" BACK-BORED TECHNOLOGY is based on extensive research and testing showing that when it comes to back-boring, .742" is the ideal 12 gauge interior barrel diameter, ensuring tight, consistent patterns. Any larger and gases blow by the shot cup and reduce pellet velocity. Too tight and the pellets are deformed as they pass through the forcing cone, causing poor ballistic performance.



CHROME PLATED CHAMBERS AND BORES are found in all Winchester® Model 101® shotguns. This critical plating provides protection from thousands of heavy, high density, abrasive loads. This extra feature virtually eliminates wear and tear caused by thousands of shells.



From the field to the range, the **INVECTOR-PLUS™ CHOKE TUBE SYSTEM** is the world's most consistent. All Model 101® shotguns come with either extended Signature or flush-mounted Invector-Plus™ tubes, depending on the model. Additional tubes are available at your local Winchester Repeating Arms dealer.



TOUGH STEEL HINGE areas bear tension from recoil with each shot, so the Model 101® shotgun is built with surfaces that are 49% larger than many competitors. The surfaces are machined simultaneously with the hinge, ensuring perfect alignment.



TRUGLO



The Model 101® shotgun's **LOCKING LUGS** have 30% more contact surface than the competition for an action that's the strongest in the industry and built to last!

MODEL 101[®] CLASSIC CLAY CRUSHERS.

If your shooting passion is trap or sporting clays Winchester Repeating Arms has a Model 101 shotgun that is perfect for you. Every Model 101 shotgun is built on a robust low-profile steel receiver specifically designed to place your forward hand and eye closer to the centerline of the bore. This gives you faster target acquisition combined with less felt recoil. The end result is a classic over and under with a crisp, smooth and controlled swing that will put more hits on your scorecard. Feel it for yourself as you bring a classic Model 101 shotgun to your shoulder.



T-Wrench, LF, IM, M, IC, SK

SPORTING

- **HIGH GLOSS GRADE II / III WALNUT STOCK WITH 20 LINES-PER-INCH CUT CHECKERING** looks elegant and improves grip
- **TRADITIONAL MODEL 101[®] SHOTGUN DIMENSIONS** give you a performance advantage plus classic styling
- **LOW-PROFILE RECEIVER** gives you faster target acquisition, a more controlled swing and less felt recoil
- **TRUGLO[®] TRU-BEAD[®] INTERCHANGEABLE FIBER-OPTIC FRONT SIGHT** offers a fast, natural sight picture
- **.742" BACK-BORED TECHNOLOGY** provides optimum shot patterns that are dense and even
- **STEEL GRIP CAP** adds a touch of classic elegance
- **EXTENDED SIGNATURE INVECTOR-PLUS[™] CHOKE TUBES** offers predictable patterns to match your situation
- **ADJUSTABLE TRIGGER SHOE** for perfect length of pull
- **HARD CHROME PLATED CHAMBERS AND BORES** make these surfaces highly resistant to wear and corrosion
- **49% MORE HINGE SURFACE AREA** than our competitors giving you greater strength for long-term wear
- **30% MORE LOCKING LUG CONTACT AREA** keeps action tighter and minimizes wear
- **PACHMAYR[®] DECELERATOR[®] RECOIL PAD** absorbs felt recoil to reduce flinch and fatigue

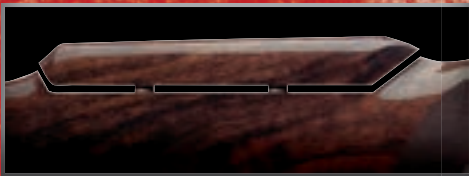

The Model 101® Pigeon Trap shotgun is available with an adjustable comb stock.



Every Model 101® Sporting and Trap shotgun comes with a durable, fitted ABS hard case embossed with the Winchester® Repeating Arms logo.



PIGEON TRAP



T-Wrench, XF, F, IM

▪ **HIGH GLOSS GRADE II / III WALNUT STOCK WITH 20 LINES-PER-INCH CUT CHECKERING** looks elegant and improves grip ▪ **ADJUSTABLE COMB OPTION** lets you custom fit the stock to your shooting style ▪ **LOW-PROFILE NICKEL PLATED RECEIVER WITH CLASSIC PIGEON ENGRAVING** gives you faster target acquisition, a more controlled swing and less felt recoil ▪ **TRUGLO® TRU-BEAD® INTERCHANGEABLE FIBER-OPTIC FRONT SIGHT** offers a true, precise sight picture ▪ **TRADITIONAL MODEL 101® SHOTGUN DIMENSIONS** give you a performance advantage plus classic styling ▪ **EXTENDED SIGNATURE INVECTOR-PLUS™ CHOKE TUBES** offer predictable patterns to match your situation ▪ **.742" BACK-BORED BARRELS** provide optimum shot patterns that are dense and even ▪ **PORTED BARRELS** reduce muzzle jump and help tame felt recoil ▪ **ADJUSTABLE TRIGGER** for perfect length of pull ▪ **HARD CHROME PLATED CHAMBERS AND BORES** make these surfaces highly resistant to wear and corrosion ▪ **WHITE LINE SPACER PACHMAYR® DECELERATOR® RECOIL PAD** provides optimal protection against felt recoil



Item Number	Gauge	Barrel Length	Chamber	Choke Tubes Included	Overall Length	Length of Pull	Drop at Comb	Drop at Heel	Nominal Wt. (lbs.)	Sugg. Retail
MODEL 101® PIGEON TRAP										
513057493	12	30"	2¾"	XF, F, IM	47⅞"	14⅝"	1½"	2⅜"	7½	\$2,469.99
513057494	12	32"	2¾"	XF, F, IM	49⅞"	14⅝"	1½"	2⅜"	7⅝	2,469.99
MODEL 101® PIGEON TRAP (ADJUSTABLE COMB)										
513059493	12	30"	2¾"	XF, F, IM	47⅞"	14⅝"	1½"*	2⅜"*	7½	\$2,629.99
513059494	12	32"	2¾"	XF, F, IM	49⅞"	14⅝"	1½"*	2⅜"*	7⅝	2,629.99
MODEL 101® SPORTING										
513054492	12	28"	2¾"	LF, IM, M, IC, SK	45⅞"	14⅝"	1⅜"	2⅜"	7⅝	\$2,319.99
513054493	12	30"	2¾"	LF, IM, M, IC, SK	47⅞"	14⅝"	1⅜"	2⅜"	7¼	2,319.99
513054494	12	32"	2¾"	LF, IM, M, IC, SK	49⅞"	14⅝"	1⅜"	2⅜"	7⅝	2,319.99

*Adjustable comb stock dimensions are measured with comb in the lowest position.

MODEL 101[®] FEATHER DUSTER.

Your four-legged hunting companion is awag in growing anticipation as you stride through the drying corn stubble with a Winchester[®] Model 101 Field shotgun across your arm. Robust and reliable, the Model 101 shotgun provides the reach and power of 3" shells while its enhanced ergonomics and premium Pachmayr[®] recoil pad offer less felt recoil. The low-profile receiver places your forward hand and eye closer to the centerline of the bore to help you keep pace with fast-flushing birds. The warmth of the glossy checkered select walnut stock contrasts nicely with the deep blue of the magnificently-polished and engraved metalwork. The end result is the perfect hunting shotgun, a timeless Belgian-made over and under you'll cherish for many years to come.





FIELD



T-Wrench, F, M, IC

- **HIGH GLOSS GRADE II / III WALNUT STOCK WITH 20 LINES-PER-INCH CUT CHECKERING** looks elegant and improves grip
- **LOW-PROFILE RECEIVER** gives you faster target acquisition, a more controlled swing and less felt recoil
- **STEEL GRIP CAP** adds a classic touch
- **.742" BACK-BORED BARRELS** provide optimum shot patterns that are dense and even
- **HARD CHROME PLATED CHAMBERS AND BORES** make these surfaces highly resistant to wear and corrosion
- **INVECTOR-PLUS™ CHOKE TUBES** offer predictable patterns to match your situation
- **49% MORE HINGE SURFACE AREA** than our competitors giving you greater strength for long-term wear
- **30% MORE LOCKING LUG CONTACT AREA** keeps action tighter and minimizes wear
- **WHITE LINE SPACER PACHMAYR® DECELERATOR® RECOIL PAD** provides optimal protection against felt recoil

Item Number	Gauge	Barrel Length	Chamber	Choke Tubes Included	Overall Length	Length of Pull	Drop at Comb	Drop at Heel	Nominal Wt. (lbs.)	Sugg. Retail
MODEL 101® FIELD										
513046371	12	26"	3"	F, M, IC	43¼"	14¼"	1¾"	2¾"	6¾	\$1,869.99
513046361	12	28"	3"	F, M, IC	45¼"	14¼"	1¾"	2¾"	7	1,869.99

HISTORICAL HISTORIC LEVERAGE.

No other firearm brand can lay claim to the legendary reputation of Winchester Repeating Arms®. Through the genius of John M. Browning, many of these all-time favorites are forever a part of America's history. When it came time to chase a band of outlaws out of town, blaze a trail across the Great Plains or face down a charging grizzly on a narrow trail in the High Rockies, the men whose legendary courage tamed the Wild West chose to arm themselves with a genuine Winchester rifle or carbine. It was the gun they carried with absolute confidence, knowing that their lives and livelihoods depended on it shooting straight and true every time they pulled the trigger.

These magnificent historic rifles are limited production models and each one is crafted to the most exacting standards. This level of quality takes time and talent, and with so many classic variations in detail — like case colored receivers, different barrel lengths, deluxe and commemorative models in both rifles and carbines — it means that Winchester Repeating Arms will not have every historic model in the product line every year.

If you want a specific model that you see in this catalog, you best get on down to your local Winchester Repeating Arms dealer and add it to your rifle rack today. It may be several years before that specific model comes back into the Winchester rifle round-up. And if you don't see the rifle or carbine that's just right for you, please be patient. You can bet your spurs Winchester Repeating Arms is already working on it for an introduction somewhere down the trail. When you want to hold history in your hands, don't settle for an off-brand or second best. Reach for a real Winchester.

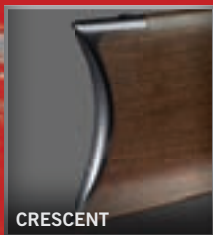

CRESCENT

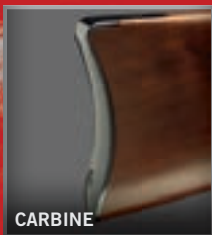

CARBINE



SHOTGUN



RIFLE FOREARM CAP



CARBINE BAND

Winchester® historic rifles have long been offered with **TRADITIONAL BUTTPLATE DESIGNS** including a **CRESCENT METAL PLATE**, a **METAL CARBINE STRAP** and several variations of the classic flat **SHOTGUN BUTTPLATE**.

Classic Winchester® firearms are often fitted with a **RIFLE FOREARM CAP** or a **CARBINE BAND** to add that authentic touch every cowboy wants.



STRAIGHT



CURVED PISTOL

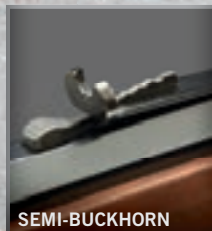

SEMI-BUCKHORN

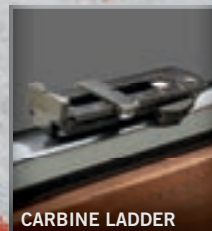

CARBINE LADDER

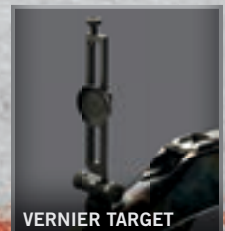

VERNIER TARGET

The **TRADITIONAL STRAIGHT GRIP** or a **CURVED PISTOL GRIP** are two hallmarks of a genuine Winchester® rifle or carbine.

Over the decades Winchester® rear sight designs have included the **SEMI-BUCKHORN**, the **CARBINE LADDER SIGHT** and the **VERNIER TARGET SIGHT**.



The **MODEL 1873** rifle is widely credited as being “The Gun that Won the West.” Chambered in several popular handgun calibers of the cowboy era, it’s been produced in carbine, rifle and musket models. Cowboy Action Shooters love the reliable Model 1873 rifle because it fires the same ammo as their revolvers.



The **MODEL 1885 HIGH WALL** rifle was John M. Browning’s first commercial firearm design for Winchester.® This stout falling-block action is so versatile it’s been chambered in pistol cartridges up to the powerful belted magnums. It’s remained the gold standard of single shot rifles for more than 125 years.



Introduced late in the year of 1885, the **MODEL 1885 LOW WALL** variant of the High Wall rifle has a smaller receiver designed to handle lower-powered cartridges. Offered in rimfire and centerfire chamberings, it’s ideal for target shooting, varmint hunting or whenever delivering one shot with pinpoint accuracy is a must.

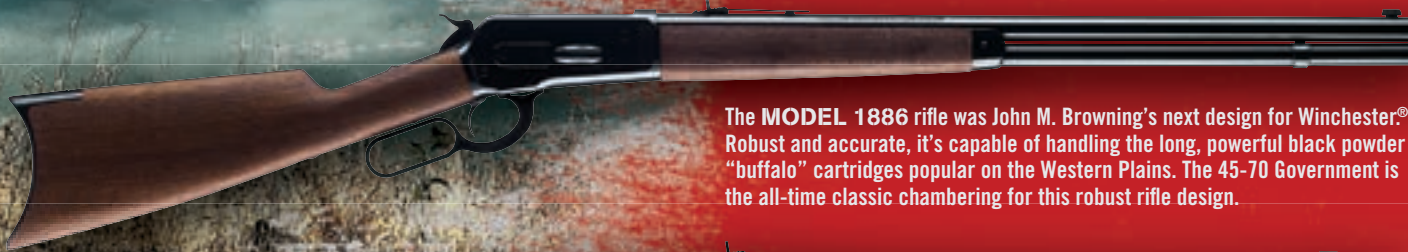

The **MODEL 1886** rifle was John M. Browning’s next design for Winchester.® Robust and accurate, it’s capable of handling the long, powerful black powder “buffalo” cartridges popular on the Western Plains. The 45-70 Government is the all-time classic chambering for this robust rifle design.

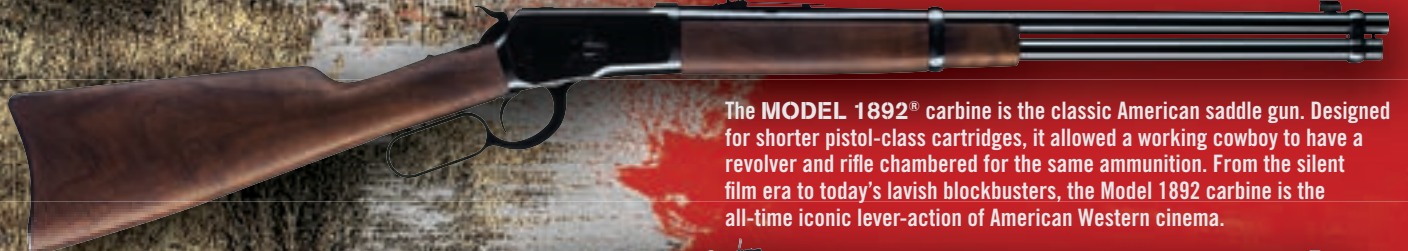

The **MODEL 1892**® carbine is the classic American saddle gun. Designed for shorter pistol-class cartridges, it allowed a working cowboy to have a revolver and rifle chambered for the same ammunition. From the silent film era to today’s lavish blockbusters, the Model 1892 carbine is the all-time iconic lever-action of American Western cinema.



The **MODEL 1894**® rifle was the quintessential American deep woods gun. Designed for mid-powered rimmed cartridges, the Model 1894 rifle has probably taken more deer than any other gun in history. Every American family ought to have at least one Model 1894 rifle in their gun rack.

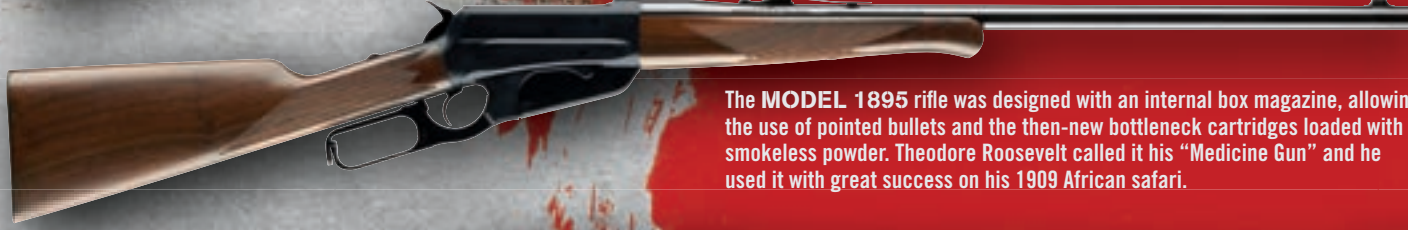

The **MODEL 1895** rifle was designed with an internal box magazine, allowing the use of pointed bullets and the then-new bottleneck cartridges loaded with smokeless powder. Theodore Roosevelt called it his “Medicine Gun” and he used it with great success on his 1909 African safari.



The **MODEL 71** rifle is a modified version of the Model 1886 rifle introduced by Winchester.® in 1935. It’s chambered for the robust 348 Winchester cartridge. Designed for taking deer, black bear and even moose, the Model 71 rifle is also perfect for taking a trophy boar on your next wild hog hunt.

MODEL 1873 THE GUN THAT WON THE WEST.

Now you can own the real thing — a genuine Winchester Repeating Arms® Model 73 rifle. They are built just like the originals with a 20" round barrel, an oil-finished walnut stock with classic steel crescent buttplate and your choice of rich bluing or stunning color case hardening. In addition to 38 Special and 357 Magnum, new this year are two all-time classic cowboy calibers — 44-40 Winchester and 45 Colt. If you're the type of avid collector who won't settle for an off-brand, second best or a copy of a copy, fill your hands with these magnificent rifles, saddle up and blaze your own trail.



	Item Number	Caliber	Magazine Capacity	Barrel Length	Overall Length	Length of Pull	Drop at Comb	Drop at Heel	Nominal Wt. (lbs.)	Rate of Twist	Sugg. Retail
MODEL 1873 SHORT RIFLE											
	534200137	357 Mag/38 Spcl	10/11	20"	39"	13"	1¼"	3"	7¼	18¾"	\$1,299.99
NEW	534200140	44-40 Win	10	20"	39"	13"	1¼"	3"	7¼	26"	1,299.99
NEW	534200141	45 Colt	10	20"	39"	13"	1¼"	3"	7¼	26"	1,299.99
MODEL 1873 COLOR CASE HARDENED											
NEW	534202137	357 Mag/38 Spcl	10/11	20"	39"	13"	1¼"	3"	7¼	18¾"	\$1,579.99
NEW	534202140	44-40 Win	10	20"	39"	13"	1¼"	3"	7¼	26"	1,579.99
NEW	534202141	45 Colt	10	20"	39"	13"	1¼"	3"	7¼	26"	1,579.99



A **FIRING PIN/STRIKER BLOCK** provides an added margin of safety.



The **ULTRA-SMOOTH ACTION** feels just like the originals from the 1800s, right out of the box.

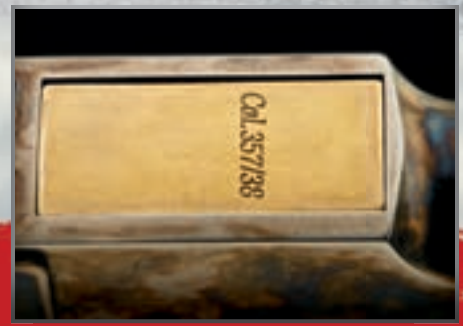

The caliber engraved **BRASS CARTRIDGE LIFTER** is designed to eject fired cases away from the shooter.



SHORT RIFLE

- **WALNUT STRAIGHT GRIP STOCK** with a satin oil finish that's velvet smooth to the touch
- **CLASSIC RIFLE-STYLE FOREARM** with blued steel cap for the timeless look and feel of the original Model 73
- **BLUED STEEL CRESCENT BUTTPLATE** slips into your shoulder for a solid hold
- **ROUND 20" BARREL WITH FULL-LENGTH MAGAZINE TUBE** holds 10 rounds of 357 Magnum, 44-40 Winchester® or 45 Colt, or 11 rounds of 38 Special ammunition
- **SEMI-BUCKHORN REAR SIGHT WITH MARBLE ARMS® GOLD BEAD FRONT SIGHT** gets you on target quickly
- **STEEL LOADING GATE** for smoother loading
- **RECEIVER REAR TANG** is drilled and tapped for optional tang-mounted rear sight for a more precise sight picture



COLOR CASE HARDENED

- **WALNUT STRAIGHT GRIP STOCK** with a satin oil finish that's velvet smooth to the touch
- **CLASSIC RIFLE-STYLE FOREARM** with color case hardened cap for the timeless look and feel of the original Model 73
- **MAGNIFICENT COLOR CASE HARDENING** on the robust steel receiver
- **COLOR CASE HARDENED STEEL CRESCENT BUTTPLATE** slips into your shoulder for a solid hold
- **ROUND 20" BARREL WITH FULL-LENGTH MAGAZINE TUBE** holds 10 rounds of 357 Magnum, 44-40 Winchester® or 45 Colt, or 11 rounds of 38 Special ammunition
- **SEMI-BUCKHORN REAR SIGHT WITH MARBLE ARMS® GOLD BEAD FRONT SIGHT** gets you on target quickly
- **STEEL LOADING GATE** for smoother loading
- **RECEIVER REAR TANG** is drilled and tapped for optional tang-mounted rear sight for a more precise sight picture

HISTORICAL

35

HISTORICAL HOLD A PAIR OF ACES.

Here are two classic rifles that embody the design genius of John M. Browning. The Model 1885 Single Shot rifle is world-renowned for its versatility, simplicity, rugged reliability and accuracy. For something a little unique, this low wall rimfire edition of the 1885 rifle is chambered in your choice of 22 LR, 22 WMR, 17 HMR or the new fire-breathing 17 Winchester® Super Magnum. The Model 1886 Short Rifle is chambered in 45-70 Gov't — it's big medicine for any game animal in North America.



Scope and mounts shown not included.

	Item Number	Caliber	Magazine Capacity	Barrel Length	Overall Length	Length of Pull	Drop at Comb	Drop at Heel	Nominal Wt. (lbs.)	Rate of Twist	Sugg. Retail
MODEL 1885 HUNTER RIMFIRE											
NEW	524100102	22 LR	N/A	24"	40"	13½"	¾"	1¼"	7½	16"	\$1,469.99
NEW	524100104	22 WMR	N/A	24"	40"	13½"	¾"	1¼"	7½	16"	1,469.99
NEW	524100170	17 HMR	N/A	24"	40"	13½"	¾"	1¼"	7½	9"	1,469.99
NEW	524100186	17 WSM	N/A	24"	40"	13½"	¾"	1¼"	7½	9"	1,469.99
MODEL 1886 SHORT RIFLE											
	534175142	45-70 Govt	8	24"	43"	13¼"	1¼"	2"	8%	20"	\$1,339.99



The **SEMI-BUCKHORN REAR SIGHT** is fully adjustable to provide a robust and accurate sight picture under almost any lighting conditions. It's a perfect solution for hunting in heavy brush or wherever quick shots at running game might be expected.



MODEL 1885 RIMFIRE

- **CHECKERED WALNUT PISTOL GRIP STOCK** with an oil finish that's velvet smooth to the touch
- **TIMELESS SCHNABEL STYLE FOREARM** with cut checkering
- **PACHMAYR® RUBBER BUTTPAD** for non-slip shooting comfort
- **OCTAGON 24" BARREL** is button rifled for outstanding accuracy
- **SEMI-BUCKHORN REAR SIGHT WITH MARBLE ARMS® GOLD BEAD FRONT SIGHT** gets you on target quickly
- **CURVED BLUED STEEL FINGER LEVER** is comfortable in the hand and smoothly activates the steel falling breechblock for loading and ejection
- **BLUED STEEL RECEIVER** is drilled and tapped for scope mounting

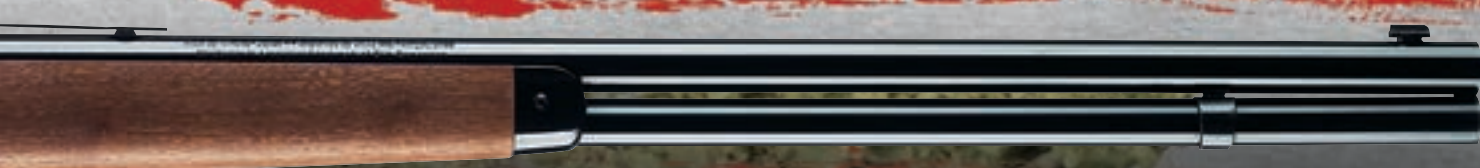

MODEL 1886 SHORT RIFLE

- **GRADE I SATIN FINISH WALNUT STOCK** for deep grain beauty
- **STRAIGHT GRIP** for genuine good looks and fast handling
- **STEEL CRESCENT BUTTPLATE** adds traditional look while protecting the buttstock
- **FULL-LENGTH MAGAZINE** provides balance, classic lines and 8-shot capacity
- **TOP-TANG SAFETY** is easy to see and operate
- **REBOUNDED HAMMER** provides added margin of safety
- **MARBLE ARMS® FRONT SIGHT** with brass bead for easier sighting
- **ADJUSTABLE REAR SIGHT** gets you on target with any ammo
- **STEEL LOADING GATE** for smoother loading
- **BARREL** is button-rifled with recessed crown for ultimate accuracy
- **RECEIVER** is drilled and tapped for traditional side mounted receiver sight



HISTORICAL

MODEL 1892[®] READY TO RIDE LIKE ROOSTER.

The tough, trail-wise Model 1892 rifle was designed to handle shorter pistol-class cartridges, allowing a hard-working cowboy to use the same type of ammunition in both his saddle gun and his revolver. Riding straight out of your favorite Hollywood western, these new variations of the classic Model 1892 rifle and carbine are ready to hit the trail. If you're a Cowboy Action Shooter you'd best fill your hands with a legendary Winchester[®] Model 1892 rifle.



	Item Number	Caliber	Magazine Capacity	Barrel Length	Overall Length	Length of Pull	Drop at Comb	Drop at Heel	Nominal Wt. (lbs.)	Rate of Twist	Sugg. Retail
MODEL 1892[®] SHORT RIFLE											
NEW	534162137	357 Mag	10	20"	37½"	12¾"	1½"	1¾"	6	18¾"	\$1,069.99
NEW	534162124	44 Rem Mag	10	20"	37½"	12¾"	1½"	1¾"	6	26"	1,069.99
NEW	534162141	45 Colt	10	20"	37½"	12¾"	1½"	1¾"	6	26"	1,069.99
MODEL 1892[®] LARGE LOOP CARBINE											
NEW	534190137	357 Mag	10	20"	37½"	12¾"	1½"	1¾"	6	18¾"	\$1,259.99
NEW	534190124	44 Rem Mag	10	20"	37½"	12¾"	1½"	1¾"	6	26"	1,259.99
NEW	534190140	44-40 Win	10	20"	37½"	12¾"	1½"	1¾"	6	26"	1,259.99
NEW	534190141	45 Colt	10	20"	37½"	12¾"	1½"	1¾"	6	26"	1,259.99



SHORT RIFLE

▪ WALNUT STRAIGHT GRIP STOCK with a satin finish that's velvet smooth to the touch ▪ CLASSIC RIFLE-STYLE FOREARM with blued steel cap for the timeless look and feel of the original Model 1892® rifle ▪ BLUED STEEL CRESCENT BUTTPLATE slips into your shoulder for a solid hold ▪ ROUND 20" BARREL WITH FULL-LENGTH MAGAZINE TUBE holds 10 rounds of 357 Magnum, 44 Magnum or 45 Colt, or 11 rounds of 38 Special ammunition ▪ SEMI-BUCKHORN REAR SIGHT WITH MARBLE ARMS® GOLD BEAD FRONT SIGHT gets you on target quickly ▪ STEEL LOADING GATE for smoother loading



LARGE LOOP CARBINE

▪ WALNUT STRAIGHT GRIP STOCK with a satin finish that's velvet smooth to the touch ▪ CLASSIC CARBINE-STYLE FOREARM with blued steel barrel band for the timeless look and feel of the original Model 1892® carbine ▪ BLUED STEEL CARBINE STRAP BUTTPLATE slips into your shoulder for a solid hold ▪ LARGE LEVER LOOP that's authentic for a Hollywood saddle carbine ▪ ROUND 20" BARREL WITH FULL-LENGTH MAGAZINE TUBE holds 10 rounds of 357 Magnum, 44 Magnum, 44-40 Winchester® or 45 Colt, or 11 rounds of 38 Special ammunition ▪ SEMI-BUCKHORN REAR SIGHT WITH MARBLE ARMS® FRONT SIGHT gets you on target quickly ▪ STEEL LOADING GATE for smoother loading

MODEL 94[®] TAKE DOWN A NICE TROPHY OR TWO.

The Model 94 rifle is the world's most popular lever-action and today's guns utilize the latest manufacturing technology to bring you the most accurate versions that Winchester Repeating Arms[®] has ever produced. The Trails End Takedown rifle incorporates John M. Browning's original takedown design to quickly separate into two compact components for easy storage or transport. The barrel on the Trails End Takedown, chambered in the hard-hitting 450 Marlin, is ported for less muzzle jump. The buttstock is fitted with a comfortable Pachmayr[®] Decelerator[®] recoil pad to help soak up recoil. The Model 94 Carbine is ideal in thick brush for deer, bear, wild hogs and other fast-moving game. Pick your Model 94 rifle or carbine and pick off your target.

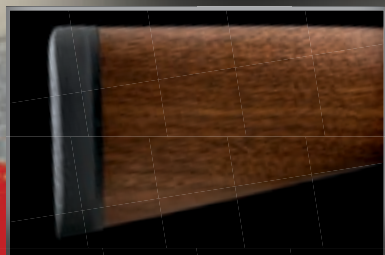

PACHMAYR[®] DECELERATOR[®] RECOIL PAD on the 450 Marlin Model 94[®] rifle soaks up felt recoil.

	Item Number	Caliber	Magazine Capacity	Barrel Length	Overall Length	Length of Pull	Drop at Comb	Drop at Heel	Nominal Wt. (lbs.)	Rate of Twist	Sugg. Retail
MODEL 94[®] TRAILS END TAKEDOWN											
	534191114	30-30 Win	6	20"	38"	13½"	1¼"	1¼"	6¼"	12"	\$1,459.99
NEW	534191117	38-55 Win	6	20"	38"	13½"	1¼"	1¼"	6¼"	15"	1,459.99
	534191160	450 Marlin	6	20"	38"	13½"	1¼"	1¼"	6¼"	20"	1,459.99
MODEL 94[®] CARBINE											
	534199114	30-30 Win	7	20"	38"	13½"	1¼"	1¼"	6½"	12"	\$1,199.99
	534199117	38-55 Win	7	20"	38"	13½"	1¼"	1¼"	6½"	15"	1,199.99

TAKE DOWN the Model 94® rifle into two compact components — the barrel assembly and the stocked receiver assembly — then slip it into your backpack, wrap it in your bedroll, strap it on your ATV or tuck it behind the seat of your truck, boat or bush plane.

REASSEMBLY is easy. Put the two pieces together, give the end of the magazine tube a few turns and you have a full-length rifle with the same superb accuracy as the other models.



BARREL PORTS on the 450 Marlin Model 94® rifle vent excess gas to help minimize muzzle jump and tame recoil.

TRAILS END TAKEDOWN

- **WALNUT STOCK** with satin finish, authentic straight-grip styling and a blued steel forearm cap offer a nostalgic look
- **TRADITIONAL JOHN M. BROWNING-DESIGNED TAKEDOWN MECHANISM** is fast and easy to operate
- **TRIPLE-CHECKED BUTTON RIFLED BARREL** for the ultimate in accuracy and precision
- **ROUND LOCKING BOLT TRUNNIONS HELP** ensure a smooth, quick lever throw
- **TOP-TANG SAFETY** is easy to see and operate
- **REBOUNDED HAMMER** provides an added margin of safety
- **BOLT RELIEF CUT** reduces hammer drag for smoother cocking
- **RADIUSED LEVER EDGES** give added protection to your fingers
- **HAMMER** is drilled and tapped for **KNURLED HAMMER SPUR EXTENSION** (included) to aid in cocking and decocking the hammer when a scope is mounted
- **MARBLE ARMS® FRONT SIGHT AND ADJUSTABLE SEMI-BUCKHORN REAR SIGHT** get you on target quickly
- **STEEL LOADING GATE** for smoother loading
- **ARTICULATED CARTRIDGE STOP** improves feeding reliability without damaging cartridges
- **DRILLED AND TAPPED FOR SCOPE MOUNTS** lets you easily attach your favorite optics

CARBINE

- **WALNUT STOCK** with satin finish, authentic straight-grip styling and a blued steel forearm band offer a nostalgic look
- **BLUED STEEL CARBINE STRAP BUTTPLATE** for smooth and easy shouldering
- **TRIPLE-CHECKED BUTTON RIFLED BARREL** for the ultimate in accuracy and precision
- **ROUND LOCKING BOLT TRUNNIONS HELP** ensure a smooth, quick lever throw
- **TOP-TANG SAFETY** is easy to see and operate
- **REBOUNDED HAMMER** provides an added margin of safety
- **BOLT RELIEF CUT** reduces hammer drag for smoother cocking
- **RADIUSED LEVER EDGES** give added protection to your fingers
- **HAMMER** is drilled and tapped for **KNURLED HAMMER SPUR EXTENSION** (included) to aid in cocking and decocking the hammer when a scope is mounted
- **MARBLE ARMS® FRONT SIGHT AND ADJUSTABLE SEMI-BUCKHORN REAR SIGHT** get you on target quickly
- **STEEL LOADING GATE** for smoother loading
- **ARTICULATED CARTRIDGE STOP** improves feeding reliability without damaging cartridges

MODEL 94

4-1

MODEL 94[®] WORLD'S MOST FAMOUS LEVER.

The Winchester[®] Model 94 rifle remains a classic because of the variety of models available and a level of accuracy that remains impressive, even by today's standards. The nostalgic Sporter model has a traditional straight-grip stock, blued steel crescent buttplate and an elegant half-round, half-octagon barrel. Its satin oil finished walnut stock is finely checkered with double-line bordering accents. The Short Rifle's 20" barrel makes it quick-swinging, lightweight and lightning fast in the brush. It has a full-length magazine and a rifle-style forearm with blued steel forearm cap. The receivers on both rifles are drilled and tapped for mounting a scope. The Winchester Model 94 rifle is a joy to own, always fun to show off and a hoot to shoot.



SPORTER

- **WALNUT STOCK** with satin finish, authentic straight-grip styling, bordered cut checkering and a blued steel forearm cap offer a nostalgic look
- **BLUED CRESCENT BUTTPLATE** slips firmly into your shoulder for a solid hold
- **TRIPLE-CHECKED HALF ROUND / HALF OCTAGON BUTT RIFLED BARREL** for the ultimate in accuracy and precision
- **ROUND LOCKING BOLT TRUNNIONS** HELP ensure a smooth, quick lever throw
- **TOP-TANG SAFETY** is easy to see and operate
- **REBOUNDED HAMMER** provides an added margin of safety
- **BOLT RELIEF CUT** reduces hammer drag for smoother cocking
- **RADIUSED LEVER EDGES** give added protection to your fingers
- **HAMMER** is drilled and tapped for **KNURLED HAMMER SPUR EXTENSION** (included) to aid in cocking and decocking the hammer when a scope is mounted
- **MARBLE ARMS[®] FRONT SIGHT AND ADJUSTABLE SEMI-BUCKHORN REAR SIGHT** get you on target quickly
- **STEEL LOADING GATE** for smoother loading
- **ARTICULATED CARTRIDGE STOP** improves feeding reliability without damaging cartridges
- **DRILLED AND TAPPED FOR SCOPE MOUNTS** lets you easily attach your favorite optics



Item Number	Caliber	Magazine Capacity	Barrel Length	Overall Length	Length of Pull	Drop at Comb	Drop at Heel	Nominal Wt. (lbs.)	Rate of Twist	Sugg. Retail
MODEL 94[®] SPORTER										
534178114	30-30 Win	8	24"	42½"	13½"	1¼"	1¾"	7½	12"	\$1,399.99
534178117	38-55 Win	8	24"	42½"	13½"	1¼"	1¾"	7½	15"	1,399.99
MODEL 94[®] SHORT RIFLE										
534174114	30-30 Win	7	20"	38"	13½"	1¼"	1¾"	6¾	12"	\$1,229.99
534174117	38-55 Win	7	20"	38"	13½"	1¼"	1¾"	6¾	15"	1,229.99



MODEL 94

SHORT RIFLE

- **WALNUT STOCK** with satin finish, authentic straight-grip styling and a blued steel forearm cap offer a nostalgic look
- **SHOTGUN STYLE BUTTPLATE** for smooth and easy shouldering
- **TRIPLE-CHECKED BUTTON RIFLED BARREL** for the ultimate in accuracy and precision
- **ROUND LOCKING BOLT TRUNNIONS HELP** ensure a smooth, quick lever throw
- **TOP-TANG SAFETY** is easy to see and operate
- **REBOUNDED HAMMER** provides an added margin of safety
- **BOLT RELIEF CUT** reduces hammer drag for smoother cocking
- **RADIUSED LEVER EDGES** give added protection to your fingers
- **HAMMER** is drilled and tapped for **KNURLED HAMMER SPUR EXTENSION** (included) to aid in cocking and decocking the hammer when a scope is mounted
- **MARBLE ARMS® FRONT SIGHT AND ADJUSTABLE SEMI-BUCKHORN REAR SIGHT** get you on target quickly
- **STEEL LOADING GATE** for smoother loading
- **ARTICULATED CARTRIDGE STOP** improves feeding reliability without damaging cartridges
- **DRILLED AND TAPPED FOR SCOPE MOUNTS** lets you easily attach your favorite optics

MODEL 70[®] TRUSTED TO BE TOUGH.

For more than 75 years the Model 70 rifle has been the best-known and most respected bolt-action design in the entire world and has endured as The Rifleman's Rifle. No other centerfire bolt-action enjoys a reputation for safety, pinpoint accuracy and robust reliability like the real thing — the Winchester[®] Model 70 rifle. Isn't it time you discovered the classic Model 70 rifle?



STAINLESS STEEL COMPONENTS

The trigger housing and all internal components of the M.O.A. Trigger System are constructed of durable, corrosion-resistant stainless steel.

ZERO TAKE-UP

Take-up is the distance the triggerpiece travels prior to the sear moving toward release and the shooter feeling resistance. The M.O.A. Trigger System uses a spring to eliminate take-up by keeping the triggerpiece in constant contact with the actuator. Unlike competitors' designs, the unique geometry of the M.O.A. pre-loads the entire trigger system to bias out normal manufacturing tolerances.

ZERO CREEP

Creep is the perceptible movement of the trigger prior to the release of the firing pin and has a negative influence on accuracy causing inconsistency and uncertainty during the pull of the trigger. Creep contributes to jerking the trigger, thus adding to movement of the gun during firing. The 2:1 mechanical advantage created by the M.O.A. Trigger's unique design geometry has virtually eliminated creep in the Model 70[®] rifle's M.O.A. Trigger.

ZERO OVERTRAVEL

Overtravel is the rearward movement of the trigger after the firing pin has been released. It can actually jar the gun away from its intended point of aim and is very distracting to the shooter. The Model 70[®] rifle's M.O.A. Trigger System is set at the factory to have no perceptible overtravel. When the sear drops, the trigger stops! Where you aim is where you shoot.

1) M.O.A. TRIGGER SYSTEM

The Model 70[®] rifle's M.O.A. Trigger System works on the simple principle of the pivoting lever. Pictured at the left are the triggerpiece (A), actuator (B), and sear (C). The housing and all internal parts, pins and springs are precision crafted from stainless steel. In addition, the sear and actuator are Slick Shot[®] electroless nickel Teflon[®] coated for corrosion resistance and smoother operation.

2) 2:1 MECHANICAL ADVANTAGE

The M.O.A.'s triggerpiece offers a wide, smooth face to better distribute finger pressure for a lighter, more sensitive feel. Because of its geometry and 2:1 mechanical advantage, the triggerpiece travels only half the distance of the actuator (2X). Since this distance is cut in half, the perception of creep and overtravel are virtually eliminated.

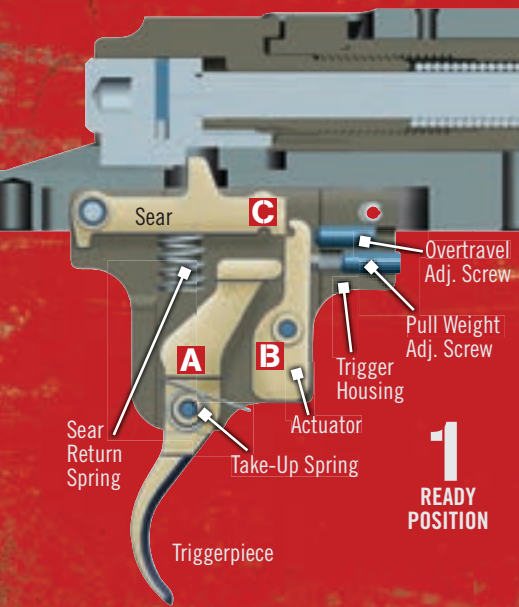

1
READY
POSITION

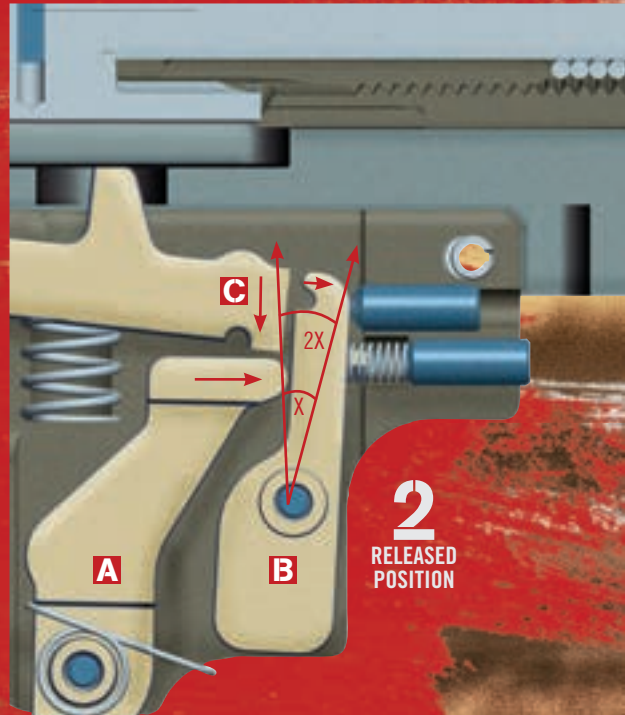

2
RELEASED
POSITION



WANNA
SEE
TOUGH?
Scan this





Every Model 70[®] rifle has a **THREE-POSITION SAFETY** that is convenient to operate with the thumb of your firing hand. The design retracts the firing pin away from the sear. When the safety selector is in the middle position, the action can still be operated, allowing unfired cartridges to be cycled with the safety on. It's smooth to engage and easily identifies by sight and feel the safety status of the rifle.

THE STEEL RECEIVER IS FORGED for superior material properties. Each forging is precision machined to create a strong, stiff and solid receiver that resists flexing and delivers top accuracy over a lifetime of shooting. The bottom profile of the Model 70[®] rifle receiver is flat to offer more surface area for bedding. It's then bedded at the front and rear to eliminate shifts in zero and preserve pinpoint accuracy. The flat bottom contour also resists twisting inside the stock during firing, making it superior to the competitors' round bottom receivers.



THE INTEGRAL RECOIL LUG on the Model 70[®] rifle is actually forged and machined as part of the receiver. It's a block of solid steel, not a mere washer or tab that's just sandwiched between the barrel and the action during assembly. This allows the barrel to be trued in perfect alignment to the front ring of the receiver for greater accuracy. There is nothing to move, settle or shift the barrel out of alignment, ever. It's what makes a Model 70 rifle shoot straight and true, year after year.



A BLADE-TYPE EJECTOR gives you full control when ejecting a fired case. Pull the bolt back slowly and the empty case pops out gently — perfect for target shooters and varminters. Pull the bolt back smartly and the empty case clears the port with greater force.

The trigger guard and magazine frame of each Model 70[®] rifle feature a solid, **ONE-PIECE BOTTOM METAL** supporting the action through the magazine well. This added rigidity contributes to accuracy and integrity better than two-piece or plastic systems. The hinged magazine floorplate speeds unloading of the cartridges, to avoid having to cycle them through the action. The action and trigger guard are held in place by stout hex head screws.



If there were a single feature responsible for the Model 70[®] rifle being labeled the "Bolt-Action Rifle of the Century," it would be the classic **CONTROLLED ROUND FEED AND CLAW EXTRACTOR (CRF)** bolt design. The Pre-'64 style massive claw extractor smoothly slips onto and secures the cartridge's base, exerting full control from the very moment it leaves the magazine and enters the chamber, gripping tightly until it's fully ejected. This time-proven design allows an unfired cartridge to be extracted even if it is not yet fully chambered.



You can expect **1 MOA ACCURACY** for three-shot groups from your Model 70[®] rifle using high-quality ammo and optics under suitable weather and range conditions.



Every Model 70[®] rifle features a **RECESSED TARGET CROWN** at the muzzle to protect the rifling from nicks and dings. Each bullet exits the barrel uniformly, with ultimate precision.

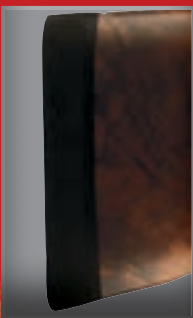

The **RECOIL PAD** on Model 70[®] rifles (except the Ultimate Shadow models) is a premium Pachmayr[®] Decelerator[®] recoil pad. This ideally contoured pad's contact area offers optimal protection against felt recoil.



A critical feature of any high-powered rifle is how the barrel is made and set in the stock. Most Model 70[®] rifle barrels are **COLD HAMMER-FORGED AND FREE-FLOATING** — forged from a solid billet of steel, shaped by massive rotary hammers over a mandrel to create the rifling. Then each barrel is stress relieved to ensure top accuracy, even during the heat of long strings of fire. The Model 70 rifle barrel is free-floating in the stock so that no part of the fore-end touches the barrel, because pressure from the stock adversely influences accuracy.

MODEL 70[®] DISTINGUISH YOURSELF.

The timeless grace and elegance of the Model 70 Super Grade rifle will take your breath away. Its highly polished, deeply-blued steel and finely checkered fancy grain walnut stock with shadowline cheekpiece define what a rifle can and should be. The Model 70 Sporter rifle is pure tradition, embodying the classic bolt-action in the hands of the serious sportsman.

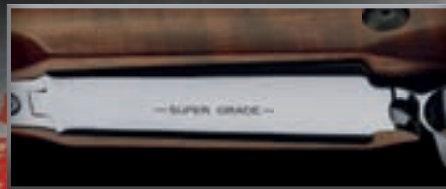

A ONE-PIECE STEEL BOTTOM METAL adds extra rigidity to the Super Grade's stock and action for improved accuracy.



THE SUPER GRADE'S SHADOWLINE CHEEKPIECE is beautifully functional, placing your eye in perfect alignment with the scope.

	Item Number	Caliber	Magazine Capacity	Barrel Length	Overall Length	Length of Pull	Drop at Comb	Drop at Heel	Nominal Wt. (lbs.)	Rate of Twist	Sugg. Retail
MODEL 70[®] SUPER GRADE											
	535203264	270 WSM	3	24"	44¼"	13¾"	½"	½"	8	10"	\$1,339.99
	535203255	300 WSM	3	24"	44¼"	13¾"	½"	½"	8	10"	1,339.99
	535203226	270 Win	5	24"	44¼"	13¾"	½"	½"	8¼	10"	1,299.99
	535203228	30-06 Sprg	5	24"	44¼"	13¾"	½"	½"	8¼	10"	1,299.99
	535203230	7mm Rem Mag	3	26"	46¼"	13¾"	½"	½"	8½	9½"	1,339.99
	535203233	300 Win Mag	3	26"	46¼"	13¾"	½"	½"	8½	10"	1,339.99
	535203236	338 Win Mag	3	26"	46¼"	13¾"	½"	½"	8½	10"	1,339.99
MODEL 70[®] SPORTER											
	535202264	270 WSM	3	24"	44¼"	13¾"	½"	½"	7¼	10"	\$919.99
	535202255	300 WSM	3	24"	44¼"	13¾"	½"	½"	7¼	10"	919.99
	535202277	325 WSM	3	24"	44¼"	13¾"	½"	½"	7¼	10"	919.99
	535202225	25-06 Rem	5	24"	44¼"	13¾"	½"	½"	7¼	10"	879.99
	535202226	270 Win	5	24"	44¼"	13¾"	½"	½"	7¼	10"	879.99
	535202228	30-06 Sprg	5	24"	44¼"	13¾"	½"	½"	7¼	10"	879.99
	535202229	264 Win Mag	3	26"	46¼"	13¾"	½"	½"	7¼	9"	919.99
	535202230	7mm Rem Mag	3	26"	46¼"	13¾"	½"	½"	7¼	9½"	919.99
	535202233	300 Win Mag	3	26"	46¼"	13¾"	½"	½"	7¼	10"	919.99
	535202236	338 Win Mag	3	26"	46¼"	13¾"	½"	½"	7¼	10"	919.99

(Scope and mounts shown not included.)





SUPER GRADE

- **GRADE IV / V FULL FANCY WALNUT STOCK WITH SHADOWLINE CHEEKPIECE** places your eye in perfect alignment with scope
- **HIGHLY POLISHED METAL SURFACES** add style and elegance
- **ONE-PIECE BOTTOM METAL WITH STEEL FLOORPLATE** adds rigidity for better accuracy
- **DECORATIVE STEEL CROSSBOLT** adds strength, rigidity and a touch of stylish refinement
- **INLETTED SLING SWIVEL STUDS** allow you to attach your favorite sling
- **FORGED STEEL RECEIVER WITH INTEGRAL RECOIL LUG IS BEDDED FRONT AND REAR** to eliminate shifts in zero for exceptional long-range accuracy
- **PRE-'64 STYLE CONTROLLED ROUND FEED WITH CLAW EXTRACTOR** fully controls the cartridge from magazine, to chamber, to ejection
- **THREE-POSITION SAFETY** shows safety status at a glance
- **COLD HAMMER-FORGED FREE-FLOATED BARREL** for years of pinpoint accuracy
- **RECESSED TARGET CROWN** enhances accuracy and protects the rifling
- **M.O.A. TRIGGER SYSTEM** with zero take-up, zero creep and zero overtravel gives you outstanding accuracy
- **BLADE-TYPE EJECTOR** for full control of ejection force
- **PACHMAYR® DECELERATOR® RECOIL PAD** for optimal protection against felt recoil



The Sporter's **RAISED CHEEKPIECE** puts your eye in perfect alignment behind a scope.

SPORTER

- **SATIN FINISH GRADE I WALNUT STOCK WITH CUT CHECKERING** and **DELUXE CHEEKPIECE** places your eye in perfect alignment with scope
- **POLISHED METAL SURFACES** add style and elegance
- **STEEL SLING SWIVEL STUDS** allow you to attach your favorite sling
- **ALLOY ONE-PIECE BOTTOM METAL** adds rigidity for better accuracy
- **FORGED STEEL RECEIVER WITH INTEGRAL RECOIL LUG IS BEDDED FRONT AND REAR** to eliminate shifts in zero for exceptional long-range accuracy
- **PRE-'64 STYLE CONTROLLED ROUND FEED WITH CLAW EXTRACTOR** fully controls the cartridge from magazine, to chamber, to ejection
- **THREE-POSITION SAFETY** shows safety status at a glance
- **COLD HAMMER-FORGED FREE-FLOATED BARREL** for years of pinpoint accuracy
- **RECESSED TARGET CROWN** enhances accuracy and protects the rifling
- **M.O.A. TRIGGER SYSTEM** with zero take-up, zero creep and zero overtravel gives you outstanding accuracy
- **BLADE-TYPE EJECTOR** for full control of ejection force
- **PACHMAYR® DECELERATOR® RECOIL PAD** for optimal protection against felt recoil

MODEL 70[®] HEAVY HITTERS.

If your next hunt takes you to Alaska or Africa, be prepared for any situation by bringing along a Model 70 rifle of the proper caliber, built on the proven Controlled Round Feed bolt-action that you can trust with your life. The benchmark is the Winchester[®] Model 70 Safari Express rifle, the gun that knowledgeable hunters of dangerous game carry when stalking the African Big Five — elephant, leopard, lion, black rhino and cape buffalo. Tailor-made for big bruins, moose and caribou is the timeless Model 70 Alaskan rifle. It features a walnut Monte Carlo stock, rear sight barrel boss, open sights and is chambered in the classic north country big game cartridges.



**MODEL
70**

Item Number	Caliber	Magazine Capacity	Barrel Length	Overall Length	Length of Pull	Drop at Comb	Drop at Heel	Sight Radius	Nominal Wt. (lbs.)	Rate of Twist	Sugg. Retail
MODEL 70[®] SAFARI EXPRESS											
535204161	375 H&H Mag	3	24"	44¾"	13¾"	½"	½"	18"	9	12"	\$1,419.99
535204139	416 Rem Mag	3	24"	44¾"	13¾"	½"	½"	18"	9	14"	1,419.99
535204144	458 Win Mag	3	24"	44¾"	13¾"	½"	½"	18"	9	14"	1,419.99
MODEL 70[®] ALASKAN											
535205128	30-06 Sprg	5	25"	45¾"	13¾"	⅝"	⅝"	18½"	8½	10"	\$1,269.99
535205133	300 Win Mag	3	25"	45¾"	13¾"	⅝"	⅝"	18½"	8½	10"	1,269.99
535205136	338 Win Mag	3	25"	45¾"	13¾"	⅝"	⅝"	18½"	8½	10"	1,269.99
535205138	375 H&H Mag	3	25"	45¾"	13¾"	⅝"	⅝"	18½"	8½	12"	1,319.99

*Drop at Monte Carlo is 2"



DOUBLE RECOIL LUGS add strength to the stock and action of the Safari Express to better handle heavy magnum recoil.

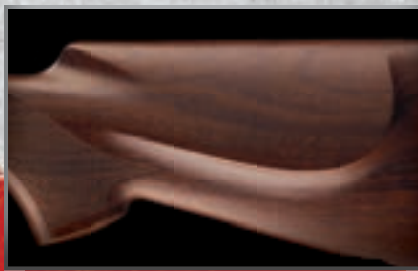

The Safari Express has a **DELUXE CHEEKPIECE** that's beautifully functional, placing your eye in perfect alignment behind either open sights or a scope.



TWO CROSS BOLTS and solid, one-piece steel bottom metal and steel floorplate add extra rigidity to the stock of the Safari Express.



SAFARI EXPRESS

- **SATIN FINISH GRADE I WALNUT STOCK WITH CUT CHECKERING** and **DELUXE CHEEKPIECE** places your eye in perfect alignment with open sights or a scope
- **ONE-PIECE BOTTOM METAL WITH STEEL FLOORPLATE** adds rigidity for better accuracy
- **MATTE FINISHED METAL SURFACES** reduce glare
- **DUAL DECORATIVE STEEL CROSSBOLTS** add strength, rigidity and a touch of stylish refinement
- **FORGED STEEL RECEIVER WITH DOUBLE INTEGRAL RECOIL LUGS IS BEDDED FRONT AND REAR** to eliminate shifts in zero for exceptional long-range accuracy
- **PRE-'64 STYLE CONTROLLED ROUND FEED WITH CLAW EXTRACTOR** fully controls the cartridge from magazine, to chamber, to ejection
- **THREE-POSITION SAFETY** shows safety status at a glance
- **COLD HAMMER-FORGED FREE-FLOATING BARREL** for years of pinpoint accuracy
- **FULLY ADJUSTABLE REAR SIGHT WITH HOODED BRASS BEAD FRONT** get you on target quickly
- **BARREL-MOUNTED FRONT SLING SWIVEL** adds a classic touch
- **RECESSED TARGET CROWN** enhances accuracy and protects the rifling
- **M.O.A. TRIGGER SYSTEM** with zero take-up, zero creep and zero overtravel gives you outstanding accuracy
- **BLADE-TYPE EJECTOR** for full control of ejection force
- **PACHMAYR® DECELERATOR® RECOIL PAD** for optimal protection against felt recoil



ALASKAN



BARREL BOSS provides a solid mounting point for the adjustable folding rear sight.

- **SATIN FINISH MONTE CARLO WALNUT STOCK WITH CUT CHECKERING** places your eye in perfect alignment with open sights or a scope
- **ALLOY ONE-PIECE BOTTOM METAL** adds rigidity for better accuracy
- **POLISHED METAL SURFACES** add style and elegance
- **FORGED STEEL RECEIVER WITH INTEGRAL RECOIL LUG IS BEDDED FRONT AND REAR** to eliminate shifts in zero for exceptional long-range accuracy
- **PRE-'64 STYLE CONTROLLED ROUND FEED WITH CLAW EXTRACTOR** fully controls the cartridge from magazine, to chamber, to ejection
- **THREE-POSITION SAFETY** shows safety status at a glance
- **COLD HAMMER-FORGED FREE-FLOATING BARREL** for years of pinpoint accuracy
- **RECESSED TARGET CROWN** enhances accuracy and protects the rifling
- **FOLDING ADJUSTABLE REAR SIGHT WITH HOODED BRASS BEAD FRONT** get you on target quickly
- **M.O.A. TRIGGER SYSTEM** with zero take-up, zero creep and zero overtravel gives you outstanding accuracy
- **BLADE-TYPE EJECTOR** for full control of ejection force
- **PACHMAYR® DECELERATOR® RECOIL PAD** for optimal protection against felt recoil

MODEL 70[®] AN ABSOLUTE CLASSIC.

The iconic all-around big game gun for generations of hunters is the Model 70 Featherweight rifle. Easy-to-carry, accurate and utterly reliable, the Featherweight is ideal for deer, varmints, hogs and antelope. Sized right for younger and smaller-statured shooters is the Featherweight Compact. A shorter length of pull allows them to experience the Winchester[®] Featherweight's easy handling and pinpoint accuracy.

M.O.A.[™]
TRIGGER SYSTEM



FEATHERWEIGHT COMPACT

▪ SATIN FINISH WALNUT STOCK WITH SHORTER LENGTH OF PULL, CLASSIC FEATHERWEIGHT CUT CHECKERING AND SCHNABEL FOREARM create the iconic Featherweight look ▪ POLISHED METAL SURFACES add style and elegance ▪ ALLOY ONE-PIECE BOTTOM METAL adds rigidity for better accuracy ▪ FORGED STEEL SHORT ACTION RECEIVER WITH INTEGRAL RECOIL LUG IS BEDDED FRONT AND REAR to eliminate shifts in zero for exceptional long-range accuracy ▪ PRE-'64 STYLE CONTROLLED ROUND FEED WITH CLAW EXTRACTOR fully controls cartridge from magazine, to chamber, to ejection ▪ THREE-POSITION SAFETY shows safety status at a glance ▪ 20" COLD HAMMER-FORGED FREE-FLOATING FEATHERWEIGHT PROFILE BARREL for years of pinpoint accuracy ▪ RECESSED TARGET CROWN enhances accuracy and protects the rifling ▪ M.O.A. TRIGGER SYSTEM with zero take-up, zero creep and zero overtravel gives you outstanding accuracy ▪ BLADE-TYPE EJECTOR for full control of ejection force ▪ PACHMAYR[®] DECELERATOR[®] RECOIL PAD for optimal protection against felt recoil



FEATHERWEIGHT

▪ SATIN FINISH WALNUT STOCK WITH CLASSIC FEATHERWEIGHT CUT CHECKERING AND SCHNABEL FOREARM create the iconic Featherweight look ▪ POLISHED METAL SURFACES add style and elegance ▪ ALLOY ONE-PIECE BOTTOM METAL adds rigidity for better accuracy ▪ FORGED STEEL RECEIVER WITH INTEGRAL RECOIL LUG IS BEDDED FRONT AND REAR to eliminate shifts in zero for exceptional long-range accuracy ▪ PRE-'64 STYLE CONTROLLED ROUND FEED WITH CLAW EXTRACTOR fully controls cartridge from magazine, to chamber, to ejection ▪ THREE-POSITION SAFETY shows safety status at a glance ▪ COLD HAMMER-FORGED FREE-FLOATING FEATHERWEIGHT PROFILE BARREL for years of pinpoint accuracy ▪ RECESSED TARGET CROWN enhances accuracy and protects the rifling ▪ M.O.A. TRIGGER SYSTEM with zero take-up, zero creep and zero overtravel gives you outstanding accuracy ▪ BLADE-TYPE EJECTOR for full control of ejection force ▪ PACHMAYR® DECELERATOR® RECOIL PAD for optimal protection against felt recoil

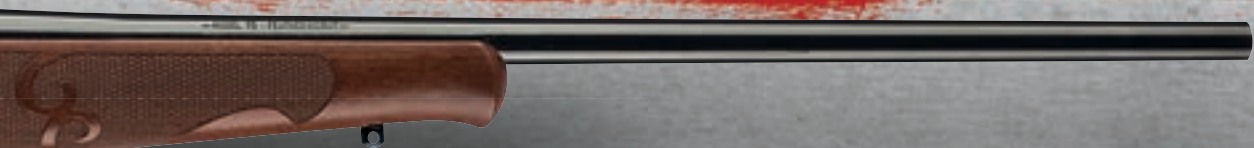

Item Number	Caliber	Magazine Capacity	Barrel Length	Overall Length	Length of Pull	Drop at Comb	Drop at Heel	Nominal Wt. (lbs.)	Rate of Twist	Sugg. Retail
MODEL 70® FEATHERWEIGHT										
535200210	22-250 Rem	5	22"	42¼"	13¾"	½"	¾"	6¾"	14"	\$879.99
535200212	243 Win	5	22"	42¼"	13¾"	½"	¾"	6¾"	10"	879.99
535200218	7mm-08 Rem	5	22"	42¼"	13¾"	½"	¾"	6¾"	9½"	879.99
535200220	308 Win	5	22"	42¼"	13¾"	½"	¾"	6¾"	12"	879.99
535200264	270 WSM	3	24"	44¼"	13¾"	½"	¾"	7	10"	919.99
535200255	300 WSM	3	24"	44¼"	13¾"	½"	¾"	7	10"	919.99
535200277	325 WSM	3	24"	44¼"	13¾"	½"	¾"	7	10"	919.99
535200225	25-06 Rem	5	22"	42¾"	13¾"	½"	¾"	7	10"	879.99
535200226	270 Win	5	22"	42¾"	13¾"	½"	¾"	7	10"	879.99
535200228	30-06 Sprg	5	22"	42¾"	13¾"	½"	¾"	7	10"	879.99
535200229	264 Win Mag	3	24"	44¾"	13¾"	½"	¾"	7¼"	9"	919.99
535200233	300 Win Mag	3	24"	44¾"	13¾"	½"	¾"	7¼"	10"	919.99
MODEL 70® FEATHERWEIGHT COMPACT										
535201210	22-250 Rem	5	20"	39½"	13"	½"	¾"	6½"	14"	\$879.99
535201212	243 Win	5	20"	39½"	13"	½"	¾"	6½"	10"	879.99
535201218	7mm-08 Rem	5	20"	39½"	13"	½"	¾"	6½"	9½"	879.99
535201220	308 Win	5	20"	39½"	13"	½"	¾"	6½"	12"	879.99

(Scope and mounts shown not included.)

MODEL®
70

51

MODEL 70[®] TAKE IT TO EXTREMES.

The Model 70 Extreme Weather SS (Stainless Steel) rifle excels in the adverse conditions that can take their toll on a lesser gun. The Model 70 Coyote Light rifle is the ideal crossover gun, capable of taking big game and varmints alike. Both of these tack drivers have free-floating fluted stainless barrels, rugged synthetic stocks with aluminum bedding blocks, Controlled Round Feeding and the M.O.A. Trigger System. These Model 70 rifles are robust, reliable and ready to go to extremes.



	Item Number	Caliber	Magazine Capacity	Barrel Length	Overall Length	Length of Pull	Drop at Comb	Drop at Heel	Nominal Wt. (lbs.)	Rate of Twist	Sugg. Retail
MODEL 70[®] EXTREME WEATHER SS											
	535206212	243 Win	5	22"	42¼"	13¾"	½"	½"	6¾"	10"	\$1,199.99
	535206218	7mm-08 Rem	5	22"	42¼"	13¾"	½"	½"	6¾"	9½"	1,199.99
	535206220	308 Win	5	22"	42¼"	13¾"	½"	½"	6¾"	12"	1,199.99
	535206264	270 WSM	3	24"	44¼"	13¾"	½"	½"	7"	10"	1,239.99
	535206255	300 WSM	3	24"	44¼"	13¾"	½"	½"	7"	10"	1,239.99
	535206277	325 WSM	3	24"	44¼"	13¾"	½"	½"	7"	10"	1,239.99
	535206225	25-06 Rem	5	22"	42¼"	13¾"	½"	½"	7½"	10"	1,199.99
	535206226	270 Win	5	22"	42¼"	13¾"	½"	½"	7½"	10"	1,199.99
	535206228	30-06 Sprg	5	22"	42¼"	13¾"	½"	½"	7½"	10"	1,199.99
	NEW 535206229	264 Win Mag	3	26"	46¾"	13¾"	½"	½"	7¼"	9"	1,239.99
	535206230	7mm Rem Mag	3	26"	46¾"	13¾"	½"	½"	7¼"	9½"	1,239.99
	535206233	300 Win Mag	3	26"	46¾"	13¾"	½"	½"	7¼"	10"	1,239.99
	535206236	338 Win Mag	3	26"	46¾"	13¾"	½"	½"	7¼"	10"	1,239.99

(Scope and mounts shown not included.)

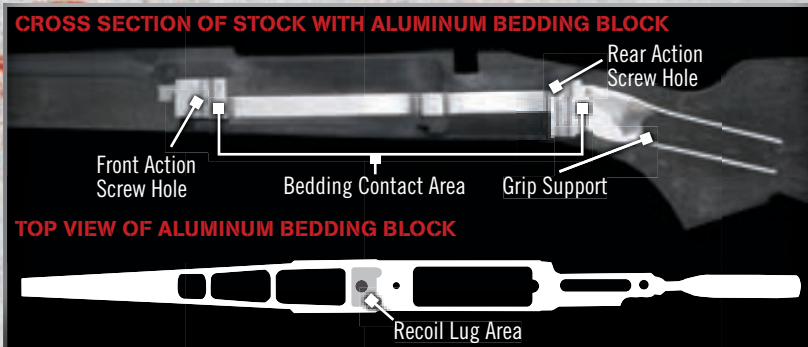

A **ONE-PIECE ALUMINUM BEDDING BLOCK** in the Extreme Weather SS and the Coyote Light is molded right into the stock during manufacturing, providing a solid, rigid base. This feature ensures flat-out reliability. The rifle holds a tight zero, placing every shot where you aim — dead on, in any weather condition, in any season.



The Extreme Weather SS has a **SCULPTED CHEEKPIECE** that's beautifully functional, placing your eye in perfect alignment behind a scope.

EXTREME WEATHER SS

- **BELL AND CARLSON™ SYNTHETIC STOCK** with **SCULPTED CHEEKPIECE** has a charcoal gray textured finish
- **ONE-PIECE ALUMINUM BEDDING BLOCK** adds strength and rigidity to maintain a reliable zero under adverse conditions
- **MATTE FINISHED METAL SURFACES** help reduce glare
- **ALLOY ONE-PIECE BOTTOM METAL** adds rigidity for better accuracy
- **FORGED STEEL RECEIVER WITH INTEGRAL RECOIL LUG IS BEDDED FRONT AND REAR** to eliminate shifts in zero for exceptional long-range accuracy
- **PRE-'64 STYLE CONTROLLED ROUND FEED WITH CLAW EXTRACTOR** fully controls the cartridge from magazine, to chamber, to ejection
- **THREE-POSITION SAFETY** shows safety status at a glance
- **SPORTER WEIGHT STAINLESS STEEL, FREE-FLOATING FLUTED BARREL** reduces weight and improves cooling
- **RECESSED TARGET CROWN** enhances accuracy and protects the rifling
- **M.O.A. TRIGGER SYSTEM** with zero take-up, zero creep and zero overtravel gives you outstanding accuracy
- **BLADE-TYPE EJECTOR** for full control of ejection force
- **PACHMAYR® DECELERATOR® RECOIL PAD** for optimal protection against felt recoil

COYOTE LIGHT

- **BELL AND CARLSON™ SYNTHETIC STOCK** has a charcoal gray textured finish and multiple fore-end vents
- **ONE-PIECE ALUMINUM BEDDING BLOCK** adds strength and rigidity to maintain a reliable zero under adverse conditions
- **MATTE FINISHED METAL SURFACES** help reduce glare
- **ALLOY ONE-PIECE BOTTOM METAL** adds rigidity for better accuracy
- **DUAL FRONT SLING SWIVEL STUDS** for sling and bipod
- **FORGED STEEL RECEIVER WITH INTEGRAL RECOIL LUG IS BEDDED FRONT AND REAR** to eliminate shifts in zero for exceptional long-range accuracy
- **PRE-'64 STYLE CONTROLLED ROUND FEED WITH CLAW EXTRACTOR** fully controls the cartridge from magazine, to chamber, to ejection
- **THREE-POSITION SAFETY** shows safety status at a glance
- **MEDIUM HEAVY STAINLESS STEEL, FREE-FLOATING FLUTED BARREL** reduces weight and improves cooling
- **RECESSED TARGET CROWN** enhances accuracy and protects the rifling
- **M.O.A. TRIGGER SYSTEM** with zero take-up, zero creep and zero overtravel gives you outstanding accuracy
- **BLADE-TYPE EJECTOR** for full control of ejection force
- **PACHMAYR® DECELERATOR® RECOIL PAD** for optimal protection against felt recoil

Item Number	Caliber	Magazine Capacity	Barrel Length	Overall Length	Length of Pull	Drop at Comb	Drop at Heel	Nominal Wt. (lbs.)	Rate of Twist	Sugg. Retail
MODEL 70® COYOTE LIGHT										
535207210	22-250 Rem	5	24"	44"	13½"	½"	½"	7½	14"	\$1,099.99
535207212	243 Win	5	24"	44"	13½"	½"	½"	7½	10"	1,099.99
535207220	308 Win	5	24"	44"	13½"	½"	½"	7½	12"	1,099.99
535207264	270 WSM	3	24"	44"	13½"	½"	½"	7½	10"	1,149.99
535207255	300 WSM	3	24"	44"	13½"	½"	½"	7½	10"	1,149.99
535207277	325 WSM	3	24"	44"	13½"	½"	½"	7½	10"	1,149.99

MODEL 70

MODEL 70[®] THE ULTIMATE HUNTING RIFLE.

Carrying a Model 70 rifle in the deep woods lets the world know you're serious about your hunting. Nothing helps you hide from wary game in those same woods more than Mossy Oak[®] Break-Up Infinity[®] camouflage. Available in either blued or stainless steel models, both of these big-game beauties have rugged synthetic stocks with raised rubber gripping surfaces, Controlled Round Feeding and the M.O.A. Trigger System. Either one will quickly prove itself as the ultimate hunting rifle for your neck of the woods.



Item Number	Caliber	Magazine Capacity	Barrel Length	Overall Length	Length of Pull	Drop at Comb	Drop at Heel	Nominal Wt. (lbs.)	Rate of Twist	Sugg. Retail
MODEL 70[®] ULTIMATE SHADOW HUNTER SS										
535209212	243 Win	5	22"	42"	13½"	¾"	¾"	6¾"	10"	\$1,039.99
535209218	7mm-08 Rem	5	22"	42"	13½"	¾"	¾"	6¾"	9½"	1,039.99
535209220	308 Win	5	22"	42"	13½"	¾"	¾"	6¾"	12"	1,039.99
535209264	270 WSM	3	24"	44"	13½"	¾"	¾"	7"	10"	1,079.99
535209255	300 WSM	3	24"	44"	13½"	¾"	¾"	7"	10"	1,079.99
535209277	325 WSM	3	24"	44"	13½"	¾"	¾"	7"	10"	1,079.99
535209226	270 Win	5	24"	44¾"	13¾"	¾"	¾"	7"	10"	1,039.99
535209228	30-06 Sprg	5	24"	44¾"	13¾"	¾"	¾"	7"	10"	1,039.99
535209233	300 Win Mag	3	26"	46¾"	13¾"	¾"	¾"	7¼"	10"	1,079.99
535209236	338 Win Mag	3	26"	46¾"	13¾"	¾"	¾"	7¼"	10"	1,079.99

(Scope and mounts shown not included.)



ULTIMATE SHADOW® HUNTER

- **LIGHTWEIGHT SYNTHETIC STOCK WITH MOSSY OAK® BREAK-UP INFINITY® CAMO** helps you hide from wary game
- **OVERMOLDED RUBBERIZED GRIPPING SURFACES** offer enhanced control
- **SATIN BLUED METAL SURFACES** help reduce glare
- **ALLOY ONE-PIECE BOTTOM METAL WITH STEEL FLOORPLATE** adds rigidity for better accuracy
- **FORGED STEEL RECEIVER WITH INTEGRAL RECOIL LUG IS BEDDED FRONT AND REAR** to eliminate shifts in zero for exceptional long-range accuracy
- **PRE-'64 STYLE CONTROLLED ROUND FEED WITH CLAW EXTRACTOR** fully controls cartridge from magazine, to chamber, to ejection
- **THREE-POSITION SAFETY** shows safety status at a glance
- **SPORTER WEIGHT FREE-FLOATING BARREL** for years of pinpoint accuracy
- **RECESSED TARGET CROWN** enhances accuracy and protects the rifling
- **M.O.A. TRIGGER SYSTEM** with zero take-up, zero creep and zero overtravel gives you outstanding accuracy
- **BLADE-TYPE EJECTOR** for full ejection control
- **WINSORB™ TECHNOLOGY RECOIL PAD** for optimal protection against felt recoil



ULTIMATE SHADOW® HUNTER SS

- **LIGHTWEIGHT SYNTHETIC STOCK WITH MOSSY OAK® BREAK-UP INFINITY® CAMO** helps you hide from wary game
- **OVERMOLDED RUBBERIZED GRIPPING SURFACES** offer enhanced control
- **MATTE METAL SURFACES** help reduce glare
- **ALLOY ONE-PIECE BOTTOM METAL WITH STEEL FLOORPLATE** adds rigidity for better accuracy
- **FORGED STAINLESS STEEL RECEIVER WITH INTEGRAL RECOIL LUG IS BEDDED FRONT AND REAR** to eliminate shifts in zero for exceptional long-range accuracy
- **PRE-'64 STYLE CONTROLLED ROUND FEED WITH CLAW EXTRACTOR** fully controls cartridge from magazine, to chamber, to ejection
- **THREE-POSITION SAFETY** shows safety status at a glance
- **SPORTER WEIGHT FREE-FLOATING STAINLESS STEEL BARREL** for years of pinpoint accuracy
- **RECESSED TARGET CROWN** enhances accuracy and protects the rifling
- **M.O.A. TRIGGER SYSTEM** with zero take-up, zero creep and zero overtravel gives you outstanding accuracy
- **BLADE-TYPE EJECTOR** for full ejection control
- **WINSORB™ TECHNOLOGY RECOIL PAD** for optimal protection against felt recoil

Item Number	Caliber	Magazine Capacity	Barrel Length	Overall Length	Length of Pull	Drop at Comb	Drop at Heel	Nominal Wt. (lbs.)	Rate of Twist	Sugg. Retail
MODEL 70® ULTIMATE SHADOW HUNTER										
535208212	243 Win	5	22"	42"	13½"	⅜"	⅜"	6¾	10"	\$829.99
535208218	7mm-08 Rem	5	22"	42"	13½"	⅜"	⅜"	6¾	9½"	829.99
535208220	308 Win	5	22"	42"	13½"	⅜"	⅜"	6¾	12"	829.99
535208264	270 WSM	3	24"	44"	13½"	⅜"	⅜"	7	10"	869.99
535208255	300 WSM	3	24"	44"	13½"	⅜"	⅜"	7	10"	869.99
535208277	325 WSM	3	24"	44"	13½"	⅜"	⅜"	7	10"	869.99
535208226	270 Win	5	24"	44¾"	13¾"	⅜"	⅜"	7	10"	829.99
535208228	30-06 Sprg	5	24"	44¾"	13¾"	⅜"	⅜"	7	10"	829.99
535208233	300 Win Mag	3	26"	46¾"	13¾"	⅜"	⅜"	7¼	10"	869.99
535208236	338 Win Mag	3	26"	46¾"	13¾"	⅜"	⅜"	7¼	10"	869.99



MODEL 70[®] THE ULTIMATE BOLT-ACTION.

The ultra-tough all-weather synthetic stock on the Model 70 Ultimate Shadow[®] rifle incorporates raised rubber gripping surfaces to create a sure hold under adverse conditions. To provide maximum strength with minimum weight, every contour and ridge has been carefully engineered. These all-black Model 70 rifles represent the ultimate in all-weather performance and are available in stainless or blued steel models.



ULTIMATE SHADOW[®]

- **LIGHTWEIGHT SYNTHETIC STOCK** for all condition durability
- **OVERMOLDED RUBBERIZED GRIPPING SURFACES** offer enhanced control
- **SATIN BLUED METAL SURFACES** reduce glare
- **ALLOY ONE-PIECE BOTTOM METAL WITH STEEL FLOORPLATE** adds rigidity for better accuracy
- **FORGED STEEL RECEIVER WITH INTEGRAL RECOIL LUG IS BEDDED FRONT AND REAR** to eliminate shifts in zero for exceptional long-range accuracy
- **PRE-'64 STYLE CONTROLLED ROUND FEED WITH CLAW EXTRACTOR** fully controls cartridge from magazine, to chamber, to ejection
- **THREE-POSITION SAFETY** shows safety status at a glance
- **SPORTER WEIGHT FREE-FLOATING BARREL** for years of pinpoint accuracy
- **RECESSED TARGET CROWN** enhances accuracy and protects the rifling
- **M.O.A. TRIGGER SYSTEM** with zero take-up, zero creep and zero overtravel gives you outstanding accuracy
- **BLADE-TYPE EJECTOR** for full ejection control
- **WINSORB™ TECHNOLOGY RECOIL PAD** for optimal protection against felt recoil

Item Number	Caliber	Magazine Capacity	Barrel Length	Overall Length	Length of Pull	Drop at Comb	Drop at Heel	Nominal Wt. (lbs.)	Rate of Twist	Sugg. Retail
MODEL 70[®] ULTIMATE SHADOW										
535210212	243 Win	5	22"	42"	13½"	¾"	¾"	6¾"	10"	\$759.99
535210218	7mm-08 Rem	5	22"	42"	13½"	¾"	¾"	6¾"	9½"	759.99
535210220	308 Win	5	22"	42"	13½"	¾"	¾"	6¾"	12"	759.99
535210264	270 WSM	3	24"	44"	13½"	¾"	¾"	7"	10"	799.99
535210255	300 WSM	3	24"	44"	13½"	¾"	¾"	7"	10"	799.99
535210277	325 WSM	3	24"	44"	13½"	¾"	¾"	7"	10"	799.99
535210225	25-06 Rem	5	24"	44¾"	13¾"	¾"	¾"	7"	10"	759.99
535210226	270 Win	5	24"	44¾"	13¾"	¾"	¾"	7"	10"	759.99
535210228	30-06 Sprg	5	24"	44¾"	13¾"	¾"	¾"	7"	10"	759.99
535210230	7mm Rem Mag	3	26"	46¾"	13¾"	¾"	¾"	7¼"	9½"	799.99
535210233	300 Win Mag	3	26"	46¾"	13¾"	¾"	¾"	7¼"	10"	799.99
535210236	338 Win Mag	3	26"	46¾"	13¾"	¾"	¾"	7¼"	10"	799.99



WinSorb™
TECHNOLOGY

WINSORB TECHNOLOGY recoil pad is specifically designed for Ultimate Shadow® composite stocks. It cushions and absorbs sharp recoil, allowing more pleasant shooting in the field and from the bench, especially with heavy magnum calibers.

ULTIMATE SHADOW® SS

- **LIGHTWEIGHT SYNTHETIC STOCK** for all condition durability
- **OVERMOLDED RUBBERIZED GRIPPING SURFACES** offer enhanced control
- **MATTE METAL SURFACES HELP** reduce glare
- **ALLOY ONE-PIECE BOTTOM METAL WITH STEEL FLOORPLATE** adds rigidity for better accuracy
- **FORGED STAINLESS STEEL RECEIVER WITH INTEGRAL RECOIL LUG IS BEDDED FRONT AND REAR** to eliminate shifts in zero for exceptional long-range accuracy
- **PRE-'64 STYLE CONTROLLED ROUND FEED WITH CLAW EXTRACTOR** fully controls cartridge from magazine, to chamber, to ejection
- **THREE-POSITION SAFETY** shows safety status at a glance
- **SPORTER WEIGHT FREE FLOATING STAINLESS STEEL BARREL** for years of pinpoint accuracy
- **RECESSED TARGET CROWN** enhances accuracy and protects the rifling
- **M.O.A. TRIGGER SYSTEM** with zero take-up, zero creep and zero overtravel gives you outstanding accuracy
- **BLADE-TYPE EJECTOR** for full ejection control
- **WINSORB™ TECHNOLOGY RECOIL PAD** for optimal protection against felt recoil

Item Number	Caliber	Magazine Capacity	Barrel Length	Overall Length	Length of Pull	Drop at Comb	Drop at Heel	Nominal Wt. (lbs.)	Rate of Twist	Sugg. Retail
MODEL 70® ULTIMATE SHADOW SS										
535211212	243 Win	5	22"	42"	13½"	⅜"	⅜"	6¾	10"	\$929.99
535211218	7mm-08 Rem	5	22"	42"	13½"	⅜"	⅜"	6¾	9½"	929.99
535211220	308 Win	5	22"	42"	13½"	⅜"	⅜"	6¾	12"	929.99
535211264	270 WSM	3	24"	44"	13½"	⅜"	⅜"	7	10"	969.99
535211255	300 WSM	3	24"	44"	13½"	⅜"	⅜"	7	10"	969.99
535211277	325 WSM	3	24"	44"	13½"	⅜"	⅜"	7	10"	969.99
535211225	25-06 Rem	5	24"	44¾"	13¾"	⅜"	⅜"	7	10"	929.99
535211226	270 Win	5	24"	44¾"	13¾"	⅜"	⅜"	7	10"	929.99
535211228	30-06 Sprg	5	24"	44¾"	13¾"	⅜"	⅜"	7	10"	929.99
535211230	7mm Rem Mag	3	26"	46¾"	13¾"	⅜"	⅜"	7¼	9½"	969.99
535211233	300 Win Mag	3	26"	46¾"	13¾"	⅜"	⅜"	7¼	10"	969.99
535211236	338 Win Mag	3	26"	46¾"	13¾"	⅜"	⅜"	7¼	10"	969.99

WINCHESTER® CHOKE TUBES

Winchester Signature choke tubes are unsurpassed in the shotgun industry. In collaboration with Briley®, one of the most renowned makers of choke tubes in the world, the Invector-Plus™ and Standard Invector™ tubes are carefully machined from the best materials and calibrated to the strictest tolerances to deliver shot patterns exceeding your highest expectations. Installing these tubes in your barrel ensures that you are getting optimum patterning for the most challenging of wild game and the most difficult presentations in clay target shooting.



Item Number	Gauge	Description	Diameter	Constriction	Sugg. Retail
SIGNATURE INVECTOR-PLUS CHOKE TUBES					
12 Gauge for Winchester Supreme, Select, Super X2, Super X3 and Super X Pump Shotguns					
61307103	12	Turkey (Camo Band)	.660	.082	\$65.00
6130703	12	Extra-Full Trap	.700	.040	65.00
6130713	12	Full	.705	.035	65.00
6130723	12	Light Full	.710	.030	65.00
6130733	12	Improved Modified	.715	.025	65.00
6130743	12	Modified	.720	.020	65.00
6130753	12	Light Modified	.725	.015	65.00
6130763	12	Improved Cylinder	.730	.010	65.00
6130773	12	Skeet	.735	.005	65.00
6130783	12	Cylinder	.740	.000	65.00
6130793	12	Spreader/Diffuser	Rifled	—	95.00

Item Number	Gauge	Description	Diameter	Constriction	Sugg. Retail
INVECTOR-PLUS CHOKE TUBES					
12 Gauge for Winchester Supreme, Select, Super X2, Super X3 and Super X Pump Shotguns					
613050	12	Extra-Full	.700	.040	\$39.00
613051	12	Full	.705	.035	39.00
613052	12	Improved Modified	.715	.025	39.00
613053	12	Modified	.720	.020	39.00
613054	12	Improved Cylinder	.730	.010	39.00
613055	12	Skeet	.735	.005	39.00
613056	12	Cylinder	.740	.000	39.00
STANDARD INVECTOR CHOKE TUBES					
12 Gauge for Winchester Super X2 Practical Models					
6130303	12	Full	.690	.035	\$28.00
6130313	12	Improved Modified	.700	.025	28.00
6130323	12	Modified	.705	.020	28.00
6130333	12	Improved Cylinder	.715	.010	28.00
6130343	12	Skeet	.720	.005	28.00
6130353	12	Cylinder	.725	.000	28.00



HINGED FLOORPLATE MAGAZINE



DETACHABLE FLOORPLATE MAGAZINE

(Ammunition shown not included.)

Item Number	Description	Sugg. Retail
SUPER X® RIFLE HINGED FLOORPLATE MAGAZINE		
112029907	30-06 Sprg	\$69.00
112029906	300 Win Mag	69.00
112029904	270 WSM	69.00
112029905	300 WSM	69.00
SUPER X® RIFLE DETACHABLE FLOORPLATE MAGAZINE		
112029903	30-06 Sprg	\$69.00
112029902	300 Win Mag	69.00
112029900	270 WSM	69.00
112029901	300 WSM	69.00

WINCHESTER® SCOPE BASES AND RINGS

Make sure your favorite Winchester® firearm carries its scope with Winchester bases and rings. Designed and manufactured with absolute precision, the integrated mount is machined from 7000-series aircraft grade aluminum alloy. It integrates the mounting base with the lower portion of the scope ring so there is nothing to come out of alignment that might cause your scope to lose zero. Integrated mounts are available in both 1" and 30mm ring diameters in low, medium or high ring heights and in your choice of a matte black or gloss black finish to match your scope and firearm. Weaver®-style alloy bases are available for Super X® Pump, Super X®3 and Super X®2 shotguns. Traditional steel bases and rings are also available in a gloss black finish for the Model 70® rifle and the Model 1885® rifle. These scope bases and rings are easy to install and should, with proper care, provide you with years of accurate and dependable service.



MODEL 70 RIFLE INTEGRATED BASES simplify mounting and help ensure your scope will stay zeroed in adverse conditions.



RINGS AND BASES are available in **GLOSS FINISH** to match scope and firearm.



BASES for WINCHESTER® SHOTGUNS accept most Weaver®-style rings.



BASES for 1885 RIFLES accept Winchester®-style rings.

Item Number	Description	Sugg. Retail
SCOPE BASES AND RINGS		
62100	Scope Set, M70, Std Height, Matte, 1"	\$88.00
62200	Scope Set, M70, Med Height, Matte, 1"	88.00
62300	Scope Set, M70, High Height, Matte, 1"	88.00
62101	Scope Set, M70, Std Height, Matte, 30mm	88.00
62201	Scope Set, M70, Med Height, Matte, 30mm	88.00
62301	Scope Set, M70, High Height, Matte, 30mm	88.00
62102	Scope Set, M70 Safari, Std Height, Matte, 1"	88.00
62202	Scope Set, M70 Safari, Med Height, Matte, 1"	88.00
62302	Scope Set, M70 Safari, High Height, Matte, 1"	88.00
62103	Scope Set, M70 Safari, Std Height, Matte, 30mm	88.00
62203	Scope Set, M70 Safari, Med Height, Matte, 30mm	88.00
62303	Scope Set, M70 Safari, High Height, Matte, 30mm	88.00
63100	Scope Set, M70, Std Height, Gloss, 1"	88.00
63200	Scope Set, M70, Med Height, Gloss, 1"	88.00
63300	Scope Set, M70, High Height, Gloss, 1"	88.00
63101	Scope Set, M70, Std Height, Gloss, 30mm	88.00
63201	Scope Set, M70, Med Height, Gloss, 30mm	88.00
63301	Scope Set, M70, High Height, Gloss, 30mm	88.00
63102	Scope Set, M70 Safari, Std Height, Gloss, 1"	88.00
63202	Scope Set, M70 Safari, Med Height, Gloss, 1"	88.00
63302	Scope Set, M70 Safari, High Height, Gloss, 1"	88.00
63103	Scope Set, M70 Safari, Std Height, Gloss, 30mm	88.00
63203	Scope Set, M70 Safari, Med Height, Gloss, 30mm	88.00
63303	Scope Set, M70 Safari, High Height, Gloss, 30mm	88.00
63500	Steel Base, M70, Gloss	53.00
63501	Steel Base, M1885 High Wall Hunter, Gloss	133.00
63502	Steel Base, M1885 Low Wall, Gloss	133.00
63600	Steel Rings, Std Height, Gloss, 1"	131.00
63601	Steel Rings, Med Height, Gloss, 1"	131.00
63602	Steel Rings, High Height, Gloss, 1"	131.00
63603	Steel Rings, Std Height, Gloss, 30mm	131.00
63604	Steel Rings, Med Height, Gloss, 30mm	131.00
63605	Steel Rings, High Height, Gloss, 30mm	131.00
62500	Alloy Base, SXP, Matte	39.00
62501	Alloy Base, SX3/SX2, Matte	39.00

	Item Number	Gauge	Chamber	Barrel Length	Description	Sugg. Retail
SUPER X[®] 3 RIFLED BARRELS						
	611108340	12	3"	22"	Matte Blued, Rifled, Cantilever Scope Mount with Synthetic Forearm*	\$579.99
	611107340	12	3"	22"	MOBU, Rifled, Cantilever Scope Mount with Synthetic Forearm*	659.99
	611121340	12	3"	22"	MOINF, Rifled, Cantilever Scope Mount with Synthetic Forearm*	659.99
NEW	611108240	12	3½"	22"	Matte Blued, Rifled, Cantilever Scope Mount with Synthetic Forearm*	539.99
NEW	611121240	12	3½"	22"	MOINF, Rifled, Cantilever Scope Mount with Synthetic Forearm*	539.99
	611062640	20	3"	22"	Matte Blued, Rifled, Cantilever Scope Mount	539.99
	611121640	20	3"	22"	MOINF, Rifled, Cantilever Scope Mount	599.99

SUPER X[®] PUMP FIELD AND TURKEY BARRELS

	611251291	12	3½"	26"	Matte Blued, Vent Rib, w/ 1 Modified Inv+ Choke	\$149.99
	611251292	12	3½"	28"	Matte Blued, Vent Rib, w/ 1 Modified Inv+ Choke	149.99
	611251391	12	3"	26"	Matte Blued, Vent Rib, w/ 1 Modified Inv+ Choke	149.99
	611251392	12	3"	28"	Matte Blued, Vent Rib, w/ 1 Modified Inv+ Choke	149.99
	611270291	12	3½"	26"	MOSGB, Vent Rib, w/ 1 Modified Inv+ Choke	189.99
	611270292	12	3½"	28"	MOSGB, Vent Rib, w/ 1 Modified Inv+ Choke	189.99
	611254291	12	3½"	26"	MODB, Vent Rib, w/ 1 Modified Inv+ Choke	189.99
	611254292	12	3½"	28"	MODB, Vent Rib, w/ 1 Modified Inv+ Choke	189.99
	611254391	12	3"	26"	MODB, Vent Rib, w/ 1 Modified Inv+ Choke	179.99
	611254392	12	3"	28"	MODB, Vent Rib, w/ 1 Modified Inv+ Choke	179.99
	611251253	12	3½"	24"	Matte Blued, Vent Rib, w/ 1 X-Full Extended Inv+ Choke	159.99
	611251353	12	3"	24"	Matte Blued, Vent Rib, w/ 1 X-Full Extended Inv+ Choke	159.99
	611257391	12	3"	26"	Matte Blued, Vent Rib 5 Shot, w/ 1 Modified Inv+ Choke	139.99
	611257392	12	3"	28"	Matte Blued, Vent Rib 5 Shot, w/ 1 Modified Inv+ Choke	139.99
	611261340	12	3"	22"	Matte Blued, Rifled, Tru-Glo Sights	139.99

Do not attempt the use of 3½" chambered barrels with 3" receivers nor 3" chambers with 3½" receivers.

*To prevent damage to forearms, these 12 gauge Super X3 rifled cantilever barrels are delivered with a new forearm specifically designed to fit over the thicker, rifled barrel wall.

	Item Number	Gauge	Chamber	Barrel Length	Description	Sugg. Retail
SUPER X[®] 3 FIELD AND TURKEY BARRELS						
	611053271	12	3½"	26"	Perma-Cote UT Gray, Vent Rib, w/ 1 Modified Inv+ Choke	\$519.99
	611053261	12	3½"	28"	Perma-Cote UT Gray, Vent Rib, w/ 1 Modified Inv+ Choke	519.99
	611054371	12	3"	26"	Perma-Cote UT Gray, Vent Rib, w/ 1 Modified Inv+ Choke	419.99
	611054361	12	3"	28"	Perma-Cote UT Gray, Vent Rib, w/ 1 Modified Inv+ Choke	419.99
	611054691	20	3"	26"	Perma-Cote UT Gray, Vent Rib, w/ 1 Modified Inv+ Choke	419.99
	611054692	20	3"	28"	Perma-Cote UT Gray, Vent Rib, w/ 1 Modified Inv+ Choke	419.99
	611123291	12	3½"	26"	Matte Blued, Vent Rib, w/ 1 Modified Inv+ Choke	459.99
	611123292	12	3½"	28"	Matte Blued, Vent Rib, w/ 1 Modified Inv+ Choke	459.99
	611123391	12	3"	26"	Matte Blued, Vent Rib, w/ 1 Modified Inv+ Choke	399.99
	611123392	12	3"	28"	Matte Blued, Vent Rib, w/ 1 Modified Inv+ Choke	399.99
	611123691	20	3"	26"	Matte Blued, Vent Rib, w/ 1 Modified Inv+ Choke	399.99
	611123692	20	3"	28"	Matte Blued, Vent Rib, w/ 1 Modified Inv+ Choke	399.99
	611155291	12	3½"	26"	MOSGB, Vent Rib, w/ 1 Modified Inv+ Choke	549.99
	611155292	12	3½"	28"	MOSGB, Vent Rib, w/ 1 Modified Inv+ Choke	549.99
	611074271	12	3½"	26"	MODB, Vent Rib, w/ 1 Modified Inv+ Choke	549.99
	611074261	12	3½"	28"	MODB, Vent Rib, w/ 1 Modified Inv+ Choke	549.99
	611155691	20	3"	26"	MOSGB, Vent Rib, w/ 1 Modified Inv+ Choke	549.99
	611115692	20	3"	28"	MOSGB, Vent Rib, w/ 1 Modified Inv+ Choke	549.99
	611074691	20	3"	26"	MODB, Vent Rib, w/ 1 Modified Inv+ Choke	549.99
	611074692	20	3"	28"	MODB, Vent Rib, w/ 1 Modified Inv+ Choke	549.99
	611117291	12	3½"	26"	MOINF, Vent Rib, w/ 1 Modified Inv+ Choke	549.99
	611117292	12	3½"	28"	MOINF, Vent Rib, w/ 1 Modified Inv+ Choke	549.99
	611117691	20	3"	26"	MOINF, Vent Rib, w/ 1 Modified Inv+ Choke	549.99
	611117692	20	3"	28"	MOINF, Vent Rib, w/ 1 Modified Inv+ Choke	549.99
	611053253	12	3½"	24"	Perma-Cote UT Gray, Vent Rib, Tru-Glo Sights, w/ 1 X-Full Extended Inv+ Choke Tube	519.99
	611053653	20	3"	24"	Perma-Cote UT Gray, Vent Rib, Tru-Glo Sights, w/ 1 X-Full Extended Inv+ Choke Tube	549.99
	611123253	12	3½"	24"	Matte Blued, Vent Rib, TRUGLO Sights, w/ 1 X-Full Extended Inv+ Choke Tube	459.99
	611123353	12	3"	24"	Matte Blued, Vent Rib, TRUGLO Sights, w/ 1 X-Full Extended Inv+ Choke Tube	399.99
	611123653	20	3"	24"	Matte Blued, Vent Rib, TRUGLO Sights, w/ 1 X-Full Extended Inv+ Choke Tube	399.99

Do not attempt the use of 3½" chambered barrels with 3" receivers nor 3" chambers with 3½" receivers.

*To prevent damage to forearms, these 12 gauge Super X3 rifled cantilever barrels are delivered with a new forearm specifically designed to fit over the thicker, rifled barrel wall.

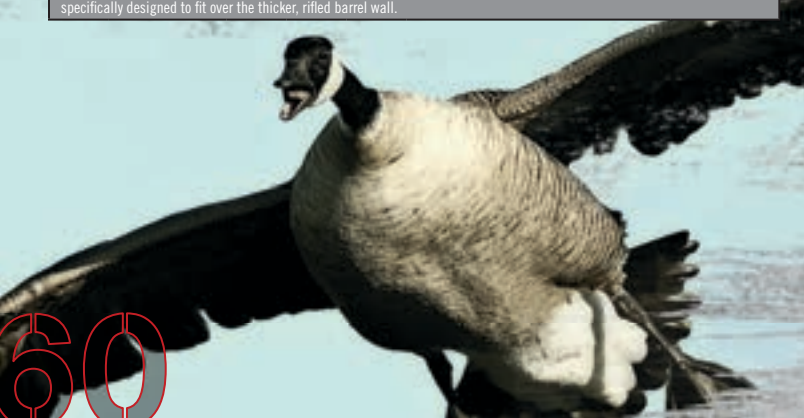



All Winchester® firearms are shipped with a free locking device to assist in the safe storage of firearms. (Not shown actual size.)



CUSTOMER SERVICE FOR WINCHESTER® FIREARMS

You can expect the same great Customer Service you've become accustomed to over the years. Expert gunsmiths can help you with the most technical problems and repairs to your firearms. There are many Authorized Repair Centers (ARC) throughout the country with gun repair professionals who know your firearm inside and out. If you need service on current models, as well as older Model 70, Model 94, Model 9422 or Model 1300 firearms, please contact one of the Authorized Repair Centers or our main Service Center in Arnold, Missouri. Please call (800) 333-3288 for more information.

WINCHESTER REPEATING ARMS®

Customer Service Department
275 Winchester Avenue
Morgan, UT 84050
(800) 945-5237
(801) 876-3440

Parts and Service
3005 Arnold Tenbrook Road
Arnold, MO 63010
(800) 322-4626

FOR FIREARMS: WINCHESTERGUNS.COM

FOR AMMUNITION: WINCHESTER.COM

Owner's manuals for all Winchester® firearms in this or previous catalogs are available upon request at no charge. Owners of Winchester firearms without owner's manuals are encouraged to view one online or request one at the address below. Some models and calibers are only made periodically. Winchester Repeating Arms (WRA) reserves the right to delay, postpone or discontinue production of any Winchester firearm for any reason without notice. All specifications in this catalog are subject to change without notice. Weights, stock dimensions, wood appearance, etc., may vary slightly between individual firearms. Wood is a natural product. No two pieces are alike and variation between stocks is to be expected. WRA reserves the right to modify or change specifications without notice. WRA will make every effort to make sure this catalog is accurate at the time of printing and apologizes for any errors in photographs, descriptions and specifications.

Please note that the following models are or were manufactured in Japan: Models 1885, 1886, 1892, 1894, 1895, 63 and 52B. Super X2, Super X3 and 101 shotguns are manufactured in Belgium and assembled in Portugal. Model 70 rifles are manufactured in the USA or in Portugal. The following trademarks are used with permission from Olin Corporation: Winchester, the Horse and Rider design, Super X, SX2 design, Super X2, SX3 design, Super X3, SXR design, Model 1892, Select, Model 101, Model 1300, Model 94, Model 70, Model Super X Pump and the red W design. Other trademarks used in this catalog: Mossy Oak Shadow Grass Blades and Mossy Oak Break-Up Infinity are registered trademarks of Haas Outdoors. Pachmayr and Decelerator are registered trademarks of Lyman. Invector-Plus, Dura-Touch and Perma-Cote are trademarks of Browning. TRUGLO is a trademark of TruGlo, Inc. Marble's is a trademark of Marble's Arms. Weaver is a registered trademark of Alliant Tech.

© Copyright, WRA, September 2013. No part of this catalog may be reproduced without the written permission of Winchester Repeating Arms. Suggested retail pricing is in U.S. dollars and approximate and subject to change without notice. If you have any questions concerning Winchester brand firearms, visit your Winchester Repeating Arms dealer or write to: Winchester Repeating Arms, 275 Winchester Ave., Morgan, UT 84050-9333. Printed in USA. GAC1309200/13133 Winchester firearms are imported by BACO, Inc. Winchester is a registered trademark of Olin Corporation.



A portion of the sale of every Winchester firearm is proudly donated to the Heritage Fund, which helps to expand the legal defense against politically motivated lawsuits against the hunting and shooting industry. Working together, the rightful tradition of firearms in America will continue.

WINCHESTER®

REPEATING ARMS

PRSR STD
U.S. POSTAGE PAID
PERMIT 315
OGDEN, UT

Winchester Repeating Arms
275 Winchester Ave., Morgan, UT
84050-9333



GOULD BROTHERS EXHIBITION SHOOTING TEAM JOINS WINCHESTER REPEATING ARMS.

Aaron and Steve Gould are the most exciting exhibition shooting team ever to dust a clay target. Wowing crowds across the nation with their incredible shooting demonstrations, the Goulds demand shotguns with the speed and reliability to set a blistering pace. That's why they insist on the Winchester® Super X®3 autoloader and the Super X® Pump shotgun.

Look for the Gould Brothers Exhibition Shooting Team at a range near you. To see them now, scan the code.

We proudly support these organizations.



WWW.  SHOOTING.COM

