

# WINCHESTER<sup>®</sup>

REPEATING ARMS

2019



Made by Istanbul - Turkey - Imported by B&C  
Winchester is a registered trademark of Olin

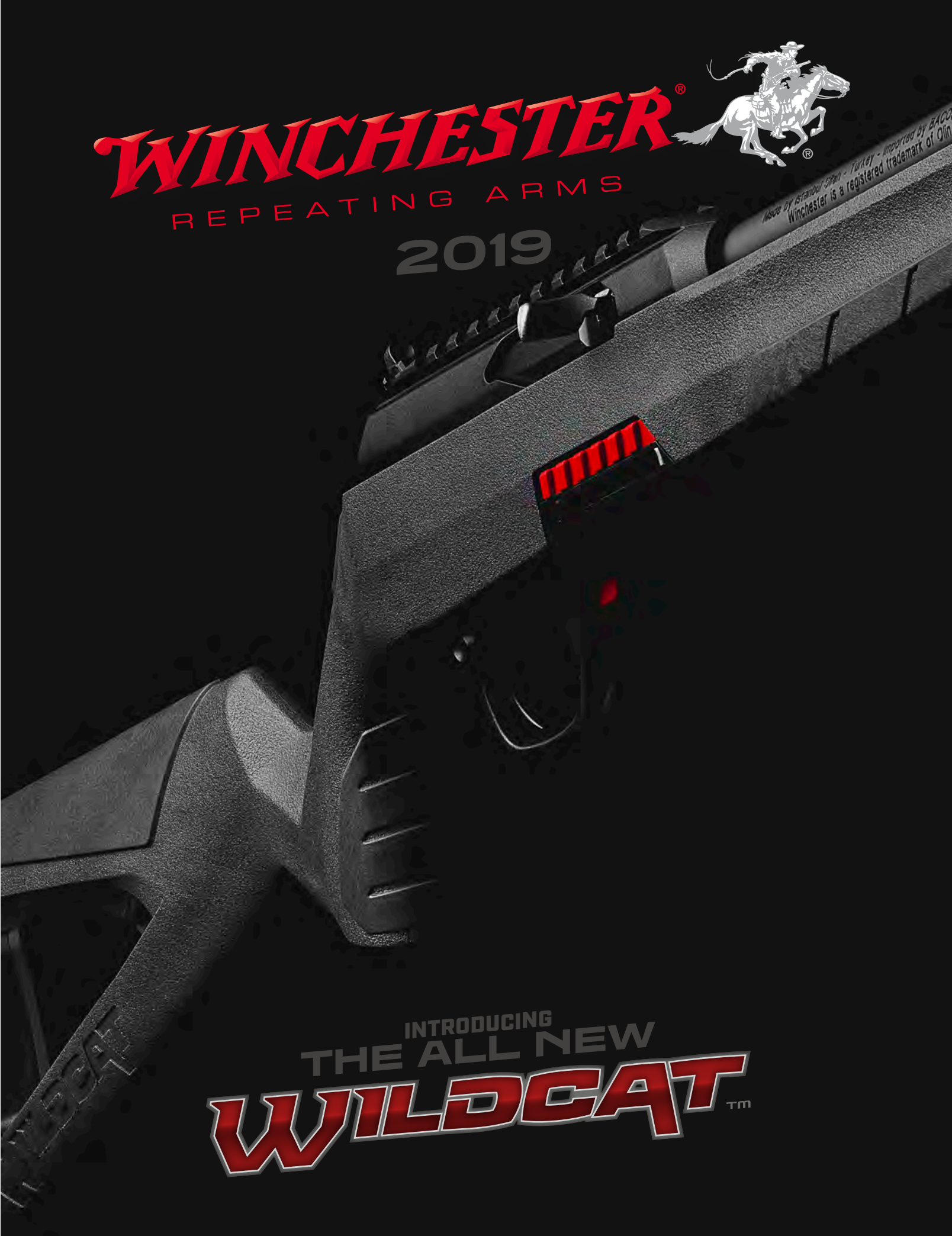

INTRODUCING  
THE ALL NEW

# WILDCAT<sup>™</sup>

# 2019

## THE NEW AUTOLOADING WILDCAT™ RIFLE IS READY TO MAKE RIMFIRE HISTORY.

The Winchester Repeating Arms® name has been an important part of rimfire rifle history for well over 100 years, and for 2019 we are pleased to mark another milestone with the introduction of the all-new Wildcat™ autoloader. Its design, styling and materials are as modern as tomorrow, and it's built with the same attention to detail for which we've always been famous. Rugged, reliable and accurate, the Wildcat is an outstanding rimfire that truly deserves a spot in your rifle rack.

The rest of our 2019 product line is an innovative mix of refined and improved models of our most popular guns, each having demonstrated outstanding accuracy and absolute reliability under the most demanding hunting and shooting conditions. 2019 marks the 125th anniversary of the introduction of the legendary Model 94® lever-action rifle. More than 7 million of these rifles and carbines have been produced, and it remains a timeless favorite of knowledgeable hunters who love its slick lever-action and slim, flat profile that carries easily in the deep woods and over rough country. Designed by John M. Browning to be the bigger brother to the Model 1892™, the Model 94®, along with the 30-30 Winchester® cartridge, quickly became the favorite of countless generations of deer hunters in North America. Untold millions of deer have ended up on the dinner table with this classic rifle/cartridge combination.

New this year are a pair of compact hunting models of the ultra-reliable, fast-cycling Super X®4 autoloader. Several models are now chambered in the ever versatile 20 gauge.

The Super X® Pump shotgun now comes in a super-compact Youth Field model so shooters of smaller stature can experience Winchester quality and performance.

Big game hunters and long-range riflemen alike will want to try the new Model 1886 chambered for the potent 45-90 Winchester® cartridge.

The affordable XPR® bolt-action rifle is now available in your choice of two very versatile camo patterns on the stock — TrueTimber® Strata™ or Kryptek® Highlander™.

Also new to the XPR line is the 350 Legend™ from Winchester Ammunition. This light-recoiling round throws a mid-caliber bullet from a smaller, straight-wall cartridge case, making it perfect for hunting wild hogs, whitetail deer and when using a sound suppressor.

The Winchester Model 70® — The Rifleman's Rifle — continues to set the standard of bolt-action rifle performance. Several models of this timeless classic are now chambered in the flat-shooting long range 6.5 Creedmoor cartridge.

Check out our entire 2019 product line in this catalog because this will be a year you'll long remember.

## CONTENTS

WILDCAT™ .....	02-05
XPR® .....	06-13
MODEL 70® .....	14-23
HISTORICAL.....	24-41
MODEL 1866.....	26-27
MODEL 1873.....	28-31
MODEL 1885.....	32-33
MODEL 1886.....	32-33
MODEL 1892™ .....	34-35
MODEL 94® .....	36-41
SUPER X® 4.....	42-51
SUPER X® PUMP.....	52-69
MODEL 101™ .....	70-75
ACCESSORIES.....	76-77
EXTRA BARRELS.....	78-79
EXPERTS.....	80-83



# WILDCAT™

**THE ULTRA-RELIABLE RIMFIRE AUTOLOADER THAT PURRS LIKE A KITTEN.**

Winchester Repeating Arms® has been building rimfires for more than a century. And for 2019, we've got an all-new rifle that's taking the rimfire autoloader to a whole new level of value and performance. Meet the Wildcat™. Light, rugged, accurate and ultra-reliable, the Wildcat is going to be the rimfire rifle you reach for whenever you want to hunt small game, teach someone to shoot or spend the afternoon rolling some tin cans around the range. Get your hands on the new Wildcat and you'll never let go.



The **LOWER RECEIVER ASSEMBLY** of the Wildcat™ is easily removed from the upper assembly by pushing a single button located at the rear of the upper assembly with your finger. No tools are required. The **MANUAL SAFETY BUTTON** is easily reversible so it's perfect for both right- and left-handed shooters.



The **MAGAZINE** ejects right into your hand. The magazine release is fully ambidextrous by using the side-mounted rails or the release tab just forward of the magazine.



The **ROTARY MAGAZINE** has metal feed lips that offer longer life and more reliable feeding. The magazine activates the bolt stop system to lock the bolt open after the last shot for safety and convenience. One 10-round magazine is included. Additional magazines are also available from your Winchester Repeating Arms® retailer.



**SPEED LOAD/UNLOAD** lets you manually relieve spring pressure on the magazine follower. Each cartridge effortlessly slips in and out during loading and unloading.

The Wildcat™ also accepts a wide range of aftermarket magazines that are compatible with the 10/22®.



A **PAIR OF ALLEN WRENCHES**, one for adjusting the rear sight and the other for removing the stock are stored in the lower receiver assembly for easy access.



The **SLIDE LOCK BUTTON** on the front of the trigger guard allows you to manually lock the action open for added safety during storage or transporting.



The **FULLY-ADJUSTABLE GHOST RING REAR SIGHT** and **RAMPED POST FRONT SIGHT** are easy to see under varying light conditions.

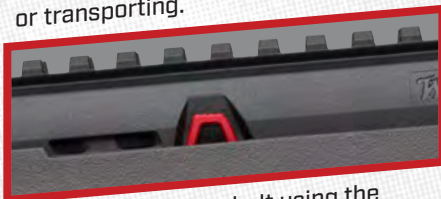

You can release the bolt using the **BOLT RELEASE BUTTON** located on the left side of the upper assembly, or by pulling back on the cocking handle with a loaded magazine in place.



The Wildcat™ has a **PRECISION BUTTON-RIFLED CHROMOLY STEEL BARREL** with a recessed target-style crown for greater accuracy.

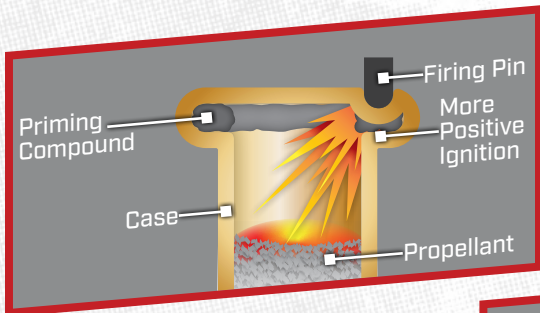

The Wildcat™ uses a **STRIKER-FIRED DESIGN** (much like a centerfire bolt-action rifle) that provides faster lock time and a lighter trigger pull than traditional hammer-fired rimfire designs. The hemispheric firing pin tip focuses its striking energy more efficiently, creating a deeper rim indent that gives more reliable ignition with all types of 22 LR ammo.

The Wildcat™ features a **HIGHLY-ERGONOMIC AMBIDEXTROUS MOLDED POLYMER STOCK** with skeletonized buttstock, upright ribbed pistol grip and rugged textured matte finish.

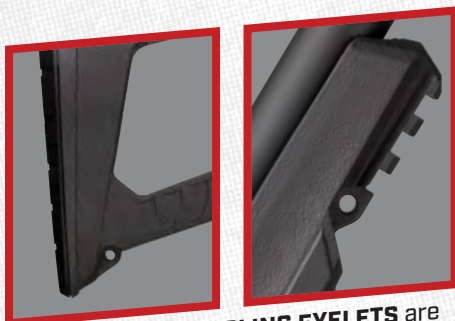

**FRONT AND REAR SLING EYELETS** are molded right into the stock.



A **PICATINNY RAIL SECTION** on the underside of the forearm tip lets you attach an optional bipod, sling mount, light or other accessory. The included rail cover protects your hand from the rail's edges and corners when accessories are not attached.



The **UPPER ASSEMBLY** has an **INTEGRAL PICATINNY TOP RAIL** so you can easily add your choice of optics or electronic sights.



**CLEANING THE BARREL IS A SNAP** because you insert the cleaning rod through the rear access port to brush out the bore and chamber from the breech end, protecting the barrel crown.



WILDCAT™

# FAST. FLAWLESS. FUN.

START MAKING A LIFETIME OF GREAT OUTDOOR MEMORIES  
WITH THE NEW WILDCAT™.





**WILDCAT® AMMO.**

Winchester® Wildcat® 22 LR ammo strikes fast and hits hard. Featuring a lead round nose bullet and clean burning powder, this value priced and accurate ammo is ideal for small game hunting, training, informal target practice and casual plinking.



**NEW WILDCAT™**

- **RUGGED POLYMER CONSTRUCTION** of the upper assembly, lower receiver assembly and ambidextrous skeletonized buttstock contribute to a featherlight overall weight of just 4 pounds
- **18" PRECISION BUTTON-RIFLED CHROMOLY STEEL BARREL** with a recessed target-style crown for greater accuracy
- **REAR ACCESS PORT** in the upper assembly allows the barrel to be easily cleaned from the breech to protect the muzzle rifling
- **LOWER RECEIVER ASSEMBLY** is easily removed from the upper assembly by pushing a single button without the need of tools
- **FULLY-ADJUSTABLE GHOST RING REAR SIGHT AND RAMPED POST FRONT SIGHT** provide a precise sight picture under varying light conditions
- **INTEGRAL PICATINNY TOP RAIL** for mounting an optional scope or electronic dot sight

- **TWO MOLDED-IN SLING EYELETS PLUS A PICATINNY RAIL SECTION** that's located under the forearm tip allow you to easily add optional accessories
- **10-ROUND ROTARY MAGAZINE** with polymer body and metal feed lips for years of reliable ammo feeding
- **FULLY AMBIDEXTROUS MAGAZINE RELEASE** using the side-mounted rails or the release tab just forward of the magazine make this rifle ideal for right- or left-handed shooters
- **SPRING-ASSISTED MAGAZINE EJECTION** drops the magazine right into the palm of your hand
- **REVERSIBLE MANUAL SAFETY BUTTON** easily adapts to right- or left-handed shooters

ITEM NUMBER	CALIBER	MAG CAP	BARREL LENGTH	OVERALL LENGTH	LENGTH OF PULL	DROP AT COMB	DROP AT HEEL	NOMINAL WT. (LBS)	RATE OF TWIST	SUGGESTED RETAIL
<b>WILDCAT NEW</b> 521100102	22 LR	10	18"	36 1/4"	13 1/2"	7/8"	7/8"	4	16"	\$249.99



# XPR<sup>®</sup>



## XPRIENCE ITS AWESOME REAL-WORLD PERFORMANCE.

The design leadership of Winchester Repeating Arms<sup>®</sup> is again on display with the innovative, feature-packed XPR<sup>®</sup>. Advanced materials join with the latest manufacturing technology to produce an extremely accurate, rugged and priced-right hunting rifle that gets the job done every time. Take your pick of traditional models in wood, black composite or in today's most popular camo patterns like Mossy Oak<sup>®</sup> Break-Up Country<sup>®</sup>, TrueTimber<sup>®</sup> Strata and Kryptek<sup>®</sup> Highlander. Also, check out the XPR models chambered in the new 350 Legend<sup>™</sup> cartridge. It's a little round with a big bullet that's ideal for wild boar, deer and sound suppressors.



### HARDENED STEEL COMPONENTS

The trigger housing and all internal components in the XPR<sup>®</sup> rifle's M.O.A. trigger are constructed of polished and hardened carbon steel, many with a blued finish for added durability and corrosion resistance. The sear and actuator are **NICKEL TEFLON<sup>®</sup>** coated for reduced friction and added wear resistance.

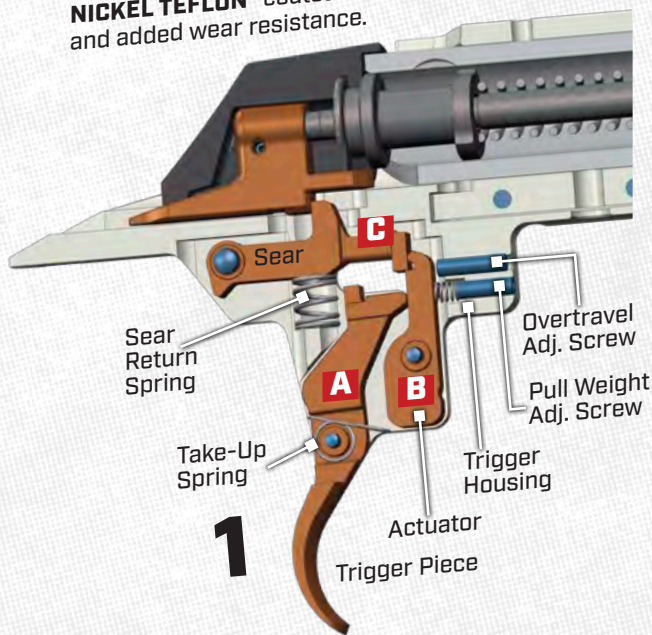

### [1] M.O.A. TRIGGER SYSTEM

The XPR<sup>®</sup> rifle's M.O.A. Trigger System works on the simple principle of the pivoting lever. Pictured above are the trigger piece [A], actuator [B], and sear [C].

### [2] 2:1 MECHANICAL ADVANTAGE

The M.O.A.'s trigger piece offers a wide, smooth face to better distribute finger pressure for a lighter, more sensitive feel. Because of its geometry and 2:1 mechanical advantage, the trigger piece travels only half the distance of the actuator (2X). Since this distance is cut in half, the perception of creep and overtravel are virtually eliminated. This means that your "feel" for the trigger is greatly enhanced, and thus your effective accuracy, both in the field and off the bench, are improved.

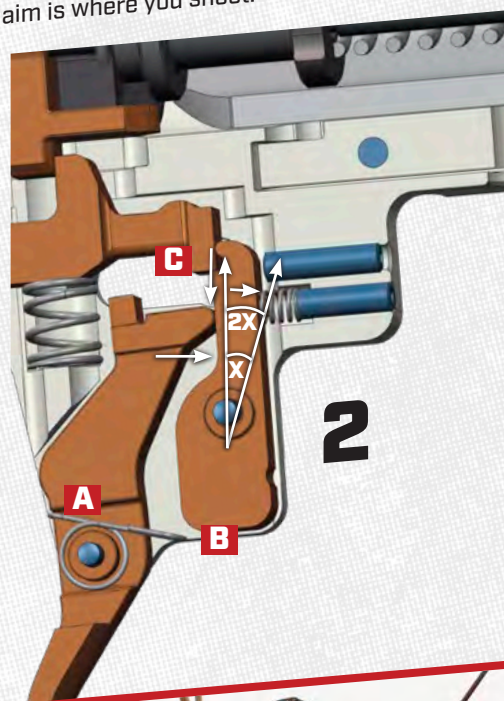

### ZERO TAKE-UP

Take-up is the distance the trigger piece travels prior to the sear moving toward release and the shooter feeling resistance. The XPR<sup>®</sup> M.O.A. Trigger System uses a spring to eliminate take-up by keeping the trigger piece in constant contact with the actuator. Unlike many competitors' designs, the unique geometry of the M.O.A. pre-loads the entire trigger system to bias out normal manufacturing tolerances.

### ZERO CREEP

Creep is the perceptible movement of the trigger prior to the release of the firing pin and has a negative influence on accuracy, causing inconsistency and uncertainty during the pull of the trigger. Creep contributes to jerking the trigger, thus adding to movement of the gun during firing. The 2:1 mechanical advantage created by this unique design geometry has virtually eliminated creep in the XPR<sup>®</sup> rifle's M.O.A. Trigger.

### ZERO OVERTRAVEL

Overtavel is the rearward movement of the trigger after the firing pin has been released. It can actually jar the gun away from its intended point of aim and is very distracting to the shooter. The XPR<sup>®</sup> adjustable M.O.A. Trigger System is set at the factory for a crisp break at about 3 1/2 pounds with no perceptible overtravel. When the sear drops, the trigger stops. Where you aim is where you shoot.

**"I HUNT IN TOUGH CONDITIONS SO I NEED A RIFLE THAT WILL HOLD UP IN BRUTAL WEATHER, RUGGED TERRAIN AND ALWAYS PERFORM. ACCURACY AND RELIABILITY ARE ABSOLUTELY NECESSARY, AND MY FIRST CHOICE IS THE WINCHESTER XPR."  
— Melissa Bachman • Winchester Deadly Passion**







Every XPR® has a **TWO-POSITION SAFETY** that's convenient to operate with the thumb of your firing hand. The safety's design fully retracts the trigger away from the actuator. Located just in front of the safety button, the **BOLT RELEASE BUTTON** allows the action to cycle unfired cartridges while the safety is on. The **COCKING INDICATOR** on the bolt shroud gives you both a tactile and visual reference of the rifle's cocked/uncocked condition.



The robust **XPR® BOLT** is crafted from chromoly steel barstock and is through-hardened during heat treatment. The bolt design offers three front locking lugs and a short 60-degree lift for improved scope clearance when cycling. The full-diameter bolt body creates a more rigid component. It is then coated with **NICKEL TEFLON®** for smoother operation and added corrosion resistance. The one-piece bolt handle is sculpted to give a more positive grip. The bolt can be fieldstripped in just seconds without special tools for cleaning and lubrication.



The one-piece **TRIGGER GUARD** and **MAGAZINE FRAME** design offers a generous guard opening for use with gloves. The **DETACHABLE BOX MAGAZINE** is constructed of a light yet rugged polymer and securely latches at both the front and rear. A single stack design feeds cartridges in a straight line to the chamber; the magazine's capacity is three rounds in both magnum and standard calibers. Additional magazines can be easily carried in a pocket or pack.

Every XPR® features a durable **PERMA-COTE™** matte black finish applied to the barrel, receiver and bolt handle to protect from wear and corrosion and to keep your rifle looking sharp for years to come.



The **CHROMOLY STEEL BARREL** on the XPR® rifle is precisely button-rifled to create outstanding accuracy with a wide variety of bullet weights and types. Every barrel is thermally stress relieved to ensure straight and true accuracy, even during long strings of fire. During manufacture, the **BARREL NUT** is set to keep the entire barrel/receiver assembly precisely aligned and allows for more accurate headspace control. This means there is nothing to shift out of position that would degrade accuracy. The entire barrel is **FREE-FLOATING** to eliminate any accuracy-robbing pressure points.

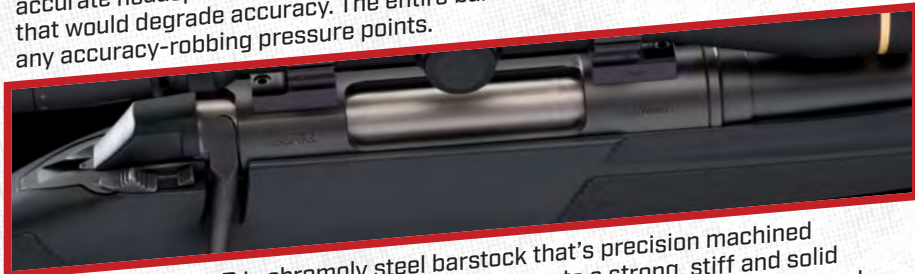

The **XPR® RECEIVER** is chromoly steel barstock that's precision machined and through-hardened during heat treating to create a strong, stiff and solid receiver capable of delivering pinpoint accuracy. The ejection port is generously sized for more reliable ejection and easier access when loading single cartridges by hand. Two socket-head action screws allow the receiver to be precisely torqued in the stock for maximum accuracy. The receiver is drilled and tapped for robust 8-40 screws, creating a more secure mounting for today's larger, high-magnification scopes.



The XPR® rifle's **ADVANCED POLYMER STOCK** comes in a choice of subdued finishes with textured panels on the fore-end and pistol grip to improve grip in cold, wet weather. The fore-end has rounded edges plus a slightly flattened bottom profile for comfortable shooting from any position. This flattened profile also optimizes stability when firing off sandbags or a rest.



A critical feature of any high-powered rifle is how the action and barrel are set in the stock. The receiver nestles onto **FLAT PROFILE INTERFACE PADS** and into a cross-mounted recoil lug to resist flex and twist when firing. The XPR will hold its zero under the most adverse conditions.

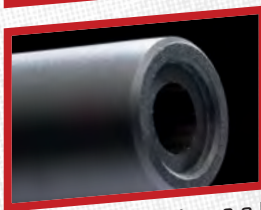

Every XPR® features a **RECESSED TARGET-STYLE CROWN** at the muzzle to protect the rifling from nicks and dings. Each bullet exits the barrel uniformly for the ultimate in downrange accuracy.



The **INFLEX TECHNOLOGY RECOIL PAD** has specially-shaped internal rib structures that redirect the recoil impulse, moving the comb down and away from your face. The ideally contoured contact area on the XPR® rifle offers optimal protection against felt recoil, even when shooting today's magnum loads.

Selected models of the XPR® are also available in a **COMPACT VERSION WITH A SHORTER 13" LENGTH OF PULL**, making it a perfect fit for younger shooters and those of smaller stature.

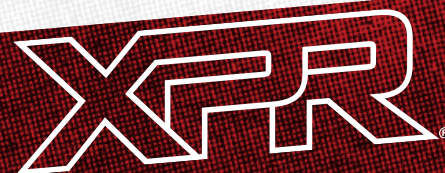

XPR®

# CLASSIC CAMO.

THE CLASSIC LOOK OF LEAVES AND BRANCHES  
BLENDS INTO MANY BACKGROUNDS.



## HUNTER

M.O.A.  
TRIGGER SYSTEM





# HUNTER COMPACT



- **M.O.A. TRIGGER SYSTEM** with zero take-up, zero creep and zero overtravel gives you outstanding accuracy
- **BOLT UNLOCK BUTTON** allows the chamber to be unloaded with the thumb safety in the on safe position
- **NICKEL TEFLON®** on the bolt body offers smoother operation and added corrosion resistance
- **DETACHABLE BOX MAGAZINE** is a single stack design constructed from a rugged polymer for greater reliability
- **ADVANCED POLYMER STOCK IN MOSSY DAK® BREAK-UP COUNTRY® CAMO** with textured panels help improve wet weather grip, while the flattened fore-end profile improves stability from sandbags or a benchrest
- **SHORTER 13" LENGTH OF PULL ON THE COMPACT MODEL** makes it perfect for younger shooters and those of smaller stature
- **PERMA-COTE™ MATTE FINISH ON THE BARREL, RECEIVER AND BOLT HANDLE** minimizes glare to help prevent game-spooking reflections and protect these parts from corrosion. Full-size guns are matte black and compact models are dark gray

- **INFLEX TECHNOLOGY RECOIL PAD** directs energy down and away from your cheek to reduce felt recoil
- **PLUSH PACHMAYR® DECELERATOR® RECOIL PAD** comes standard on the XPR® Hunter Compact model
- **STEEL RECOIL LUG** is inletted into the stock to prevent the receiver from twisting under recoil for more reliable and predictable long-range accuracy
- **RECEIVER IS MACHINED FROM SOLID STEEL BAR STOCK** and through-hardened during heat treating for longer life and enhanced accuracy
- **TWO-POSITION THUMB SAFETY** and a cocking indicator show the XPR® rifle's safety status at a glance or by feel
- **BUTTON-RIFLED, FREE-FLOATED STEEL BARREL** is thermally stress-relieved then precisely aligned and headspaced during assembly via the barrel nut
- **RECESSED TARGET CROWN** protects the muzzle rifling from wear and impact damage to help maintain greater accuracy

**THE ALL NEW WINCHESTER® 350 LEGEND™**  
 For over 150 years, Winchester Ammunition has led the way in innovation, developing some of the world's most popular calibers. That tradition continues with the 350 Legend, a straight-wall cartridge built with the hunter and sport shooter in mind. This light-recoiling, hard-hitting round is available throughout the XPR® line.



(CARTRIDGE SHOWN ACTUAL SIZE.)



ITEM NUMBER	CALIBER	MAG CAP	BARREL LENGTH	OVERALL LENGTH	LENGTH OF PULL	DROP AT COMB	DROP AT HEEL	NOMINAL WT. (LBS)	RATE OF TWIST	SUGGESTED RETAIL
<b>XPR HUNTER COMPACT (MOSSY DAK BREAK-UP COUNTRY)</b>										
535721212	243 Win	3	20"	39 1/4"	13"	1/2"	3/4"	6 1/2	10"	\$599.99
535721289	6.5 Creedmoor	3	20"	39 1/4"	13"	1/2"	3/4"	6 1/2	8"	599.99
535721218	7mm-08 Rem	3	20"	39 1/4"	13"	1/2"	3/4"	6 1/2	9 1/2"	599.99
535721220	308 Win	3	20"	39 1/4"	13"	1/2"	3/4"	6 1/2	16"	599.99
<b>NEW</b> 535721296	350 Legend	3	20"	39 1/4"	13"	1/2"	3/4"	6 3/4	10"	599.99
535721264	270 WSM	3	22"	41 1/4"	13"	1/2"	3/4"	6 3/4	10"	599.99
535721255	300 WSM	3	22"	41 1/4"	13"	1/2"	3/4"	6 3/4	10"	599.99
535721277	325 WSM	3	22"	41 1/4"	13"	1/2"	3/4"	6 3/4	10"	599.99
<b>XPR HUNTER (MOSSY DAK BREAK-UP COUNTRY)</b>										
535704212	243 Win	3	22"	42"	13 3/4"	1/2"	3/4"	6 3/4	10"	\$599.99
535704289	6.5 Creedmoor	3	22"	42"	13 3/4"	1/2"	3/4"	6 3/4	8"	599.99
535704218	7mm-08 Rem	3	22"	42"	13 3/4"	1/2"	3/4"	6 3/4	9 1/2"	599.99
535704220	308 Win	3	22"	42"	13 3/4"	1/2"	3/4"	6 3/4	12"	599.99
<b>NEW</b> 535704296	350 Legend	3	22"	42"	13 3/4"	1/2"	3/4"	7	10"	599.99
535704264	270 WSM	3	24"	44"	13 3/4"	1/2"	3/4"	7	10"	599.99
535704255	300 WSM	3	24"	44"	13 3/4"	1/2"	3/4"	7	10"	599.99
535704277	325 WSM	3	24"	44"	13 3/4"	1/2"	3/4"	7	10"	599.99
535704226	270 Win	3	24"	44 1/2"	13 3/4"	1/2"	3/4"	7	10"	599.99
535704228	30-06 Sprg	3	24"	44 1/2"	13 3/4"	1/2"	3/4"	7 1/4	9 1/2"	599.99
535704230	7mm Rem Mag	3	26"	46 1/2"	13 3/4"	1/2"	3/4"	7 1/4	10"	599.99
535704233	300 Win Mag	3	26"	46 1/2"	13 3/4"	1/2"	3/4"	7 1/4	10"	599.99
535704236	338 Win Mag	3	26"	46 1/2"	13 3/4"	1/2"	3/4"	7 1/4	10"	599.99

- **STRAIGHT-WALL CASE PROFILE** with a 35 caliber bullet
- **MORE ENERGY** than the 223 Remington®
- **LESS RECOIL** than either the 243 Winchester® or 6.5 Creedmoor
- **TRAJECTORY** similar to the 30-30 Winchester



XPR<sup>®</sup>

# LOOKIN' GOOD.

TWO GREAT NEW CAMO CHOICES  
FOR THE XPR<sup>®</sup>



**NEW** HUNTER  
HIGHLANDER

M.O.A.<sup>™</sup>  
TRIGGER SYSTEM





# NEW HUNTER STRATA



- **M.O.A. TRIGGER SYSTEM** with zero take-up, zero creep and zero overtravel gives you outstanding accuracy
- **BOLT UNLOCK BUTTON** allows the chamber to be unloaded with the thumb safety in the on safe position
- **NICKEL TEFLON®** on the bolt body offers smoother operation and added corrosion resistance
- **DETACHABLE BOX MAGAZINE** is a single stack design constructed from a rugged polymer for greater reliability
- **ADVANCED POLYMER STOCK IN YOUR CHOICE OF TRUETIMBER® STRATA™ OR KRYPTEK® HIGHLANDER™ CAMO** with textured panels help improve wet weather grip, while the flattened fore-end profile improves stability from sandbags or a benchrest
- **PERMA-COTE™ FINISH ON THE BARREL, RECEIVER AND BOLT HANDLE** minimizes glare to help prevent game-spooking reflections and protects these parts from corrosion

- **INFLEX TECHNOLOGY RECOIL PAD** directs energy down and away from your cheek to reduce felt recoil
- **STEEL RECOIL LUG** is inletted into the stock to prevent the receiver from twisting under recoil for more reliable and predictable long-range accuracy
- **RECEIVER IS MACHINED FROM SOLID STEEL BAR STOCK** and through-hardened during heat treating for longer life and enhanced accuracy
- **TWO-POSITION THUMB SAFETY** and a cocking indicator show the XPR® rifle's safety status at a glance or by feel
- **BUTTON-RIFLED, FREE-FLOATED STEEL BARREL** is thermally stress-relieved then precisely aligned and headspaced during assembly via the barrel nut
- **RECESSED TARGET CROWN** protects the muzzle rifling from wear and impact damage to help maintain greater accuracy

ITEM NUMBER	CALIBER	MAG CAP	BARREL LENGTH	OVERALL LENGTH	LENGTH OF PULL	DROP AT COMB	DROP AT HEEL	NOMINAL WT. (LBS)	RATE OF TWIST	SUGGESTED RETAIL
<b>XPR HUNTER STRATA</b>										
NEW 535741212	243 Win	3	22"	41 1/4"	13 3/4"	1/2"	3/4"	6 3/4	10"	\$599.99
NEW 535741289	6.5 Creedmoor	3	22"	41 1/4"	13 3/4"	1/2"	3/4"	6 3/4	8"	599.99
NEW 535741218	7mm-08 Rem	3	22"	41 1/4"	13 3/4"	1/2"	3/4"	6 3/4	9 1/2"	599.99
NEW 535741218	308 Win	3	22"	41 1/4"	13 3/4"	1/2"	3/4"	6 3/4	12"	599.99
NEW 535741220	350 Legend	3	22"	41 1/4"	13 3/4"	1/2"	3/4"	6 3/4	16"	599.99
NEW 535741296	270 WSM	3	24"	43 1/4"	13 3/4"	1/2"	3/4"	7	10"	599.99
NEW 535741264	300 WSM	3	24"	43 1/4"	13 3/4"	1/2"	3/4"	7	10"	599.99
NEW 535741255	325 WSM	3	24"	43 1/4"	13 3/4"	1/2"	3/4"	7	10"	599.99
NEW 535741277	270 Win	3	24"	44 1/2"	13 3/4"	1/2"	3/4"	7	10"	599.99
NEW 535741226	30-06 Sprg	3	24"	44 1/2"	13 3/4"	1/2"	3/4"	7 1/4	9 1/2"	599.99
NEW 535741228	7mm Rem Mag	3	26"	46 1/2"	13 3/4"	1/2"	3/4"	7 1/4	10"	599.99
NEW 535741230	300 Win Mag	3	26"	46 1/2"	13 3/4"	1/2"	3/4"	7 1/4	10"	599.99
NEW 535741233	338 Win Mag	3	26"	46 1/2"	13 3/4"	1/2"	3/4"	7 1/4	10"	599.99
NEW 535741236	338 Win Mag	3	26"	46 1/2"	13 3/4"	1/2"	3/4"	7 1/4	10"	599.99
<b>XPR HUNTER HIGHLANDER</b>										
NEW 535726212	243 Win	3	22"	41 1/4"	13 3/4"	1/2"	3/4"	6 3/4	10"	\$599.99
NEW 535726289	6.5 Creedmoor	3	22"	41 1/4"	13 3/4"	1/2"	3/4"	6 3/4	8"	599.99
NEW 535726218	7mm-08 Rem	3	22"	41 1/4"	13 3/4"	1/2"	3/4"	6 3/4	9 1/2"	599.99
NEW 535726218	308 Win	3	22"	41 1/4"	13 3/4"	1/2"	3/4"	6 3/4	12"	599.99
NEW 535726220	350 Legend	3	22"	41 1/4"	13 3/4"	1/2"	3/4"	6 3/4	16"	599.99
NEW 535726296	270 WSM	3	24"	43 1/4"	13 3/4"	1/2"	3/4"	7	10"	599.99
NEW 535726264	300 WSM	3	24"	43 1/4"	13 3/4"	1/2"	3/4"	7	10"	599.99
NEW 535726255	325 WSM	3	24"	43 1/4"	13 3/4"	1/2"	3/4"	7	10"	599.99
NEW 535726277	270 Win	3	24"	44 1/2"	13 3/4"	1/2"	3/4"	7	10"	599.99
NEW 535726226	30-06 Sprg	3	24"	44 1/2"	13 3/4"	1/2"	3/4"	7 1/4	9 1/2"	599.99
NEW 535726228	7mm Rem Mag	3	26"	46 1/2"	13 3/4"	1/2"	3/4"	7 1/4	10"	599.99
NEW 535726230	300 Win Mag	3	26"	46 1/2"	13 3/4"	1/2"	3/4"	7 1/4	10"	599.99
NEW 535726233	338 Win Mag	3	26"	46 1/2"	13 3/4"	1/2"	3/4"	7 1/4	10"	599.99
NEW 535726236	338 Win Mag	3	26"	46 1/2"	13 3/4"	1/2"	3/4"	7 1/4	10"	599.99

(SCOPE AND MOUNTS SHOWN NOT INCLUDED)



# ALL ABOUT ACCURACY.

THE AFFORDABLE HUNTING RIFLE THAT DELIVERS OUTSTANDING REAL-WORLD ACCURACY ON EVERY SHOT.



	ITEM NUMBER	CALIBER	MAG CAP	BARREL LENGTH	OVERALL LENGTH	LENGTH OF PULL	DROP AT COMB	DROP AT HEEL	NOMINAL WT. (LBS)	RATE OF TWIST	SUGGESTED RETAIL
<b>XPR SPORTER</b>											
	535709212	243 Win	3	22"	42"	13 3/4"	1/2"	3/4"	6 3/4	10"	\$599.99
	535709289	6.5 Creedmoor	3	22"	42"	13 3/4"	1/2"	3/4"	6 3/4	8"	599.99
	535709218	7mm-08 Rem	3	22"	42"	13 3/4"	1/2"	3/4"	6 3/4	9 1/2"	599.99
	535709220	308 Win	3	22"	42"	13 3/4"	1/2"	3/4"	6 3/4	12"	599.99
<b>NEW</b>	535709296	350 Legend	3	22"	42"	13 3/4"	1/2"	3/4"	7	10"	599.99
	535709264	270 WSM	3	24"	44"	13 3/4"	1/2"	3/4"	7	10"	599.99
	535709255	300 WSM	3	24"	44"	13 3/4"	1/2"	3/4"	7	10"	599.99
	535709277	325 WSM	3	24"	44 1/2"	13 3/4"	1/2"	3/4"	7	10"	599.99
	535709226	270 Win	3	24"	44 1/2"	13 3/4"	1/2"	3/4"	7 1/4	9 1/2"	599.99
	535709228	30-06 Sprg	3	26"	46 1/2"	13 3/4"	1/2"	3/4"	7 1/4	10"	599.99
	535709230	7mm Rem Mag	3	26"	46 1/2"	13 3/4"	1/2"	3/4"	7 1/4	10"	599.99
	535709233	300 Win Mag	3	26"	46 1/2"	13 3/4"	1/2"	3/4"	7 1/4	10"	599.99
	535709236	338 Win Mag	3	26"	46 1/2"	13 3/4"	1/2"	3/4"	7 1/4	10"	599.99
<b>XPR</b>											
	535700212	243 Win	3	22"	42"	13 3/4"	1/2"	3/4"	6 3/4	10"	\$549.99
	535700289	6.5 Creedmoor	3	22"	42"	13 3/4"	1/2"	3/4"	6 3/4	8"	549.99
	535700218	7mm-08 Rem	3	22"	42"	13 3/4"	1/2"	3/4"	6 3/4	9 1/2"	549.99
	535700220	308 Win	3	22"	42"	13 3/4"	1/2"	3/4"	6 3/4	12"	549.99
<b>NEW</b>	535700296	350 Legend	3	22"	42"	13 3/4"	1/2"	3/4"	7	10"	549.99
	535700264	270 WSM	3	24"	44"	13 3/4"	1/2"	3/4"	7	10"	549.99
	535700255	300 WSM	3	24"	44"	13 3/4"	1/2"	3/4"	7	10"	549.99
	535700277	325 WSM	3	24"	44 1/2"	13 3/4"	1/2"	3/4"	7	10"	549.99
	535700226	270 Win	3	24"	44 1/2"	13 3/4"	1/2"	3/4"	7 1/4	9 1/2"	549.99
	535700228	30-06 Sprg	3	26"	46 1/2"	13 3/4"	1/2"	3/4"	7 1/4	10"	549.99
	535700230	7mm Rem Mag	3	26"	46 1/2"	13 3/4"	1/2"	3/4"	7 1/4	10"	549.99
	535700233	300 Win Mag	3	26"	46 1/2"	13 3/4"	1/2"	3/4"	7 1/4	10"	549.99
	535700236	338 Win Mag	3	26"	46 1/2"	13 3/4"	1/2"	3/4"	7 1/4	10"	549.99
<b>XPR COMPACT</b>											
	535720212	243 Win	3	20"	39 1/4"	13"	1/2"	3/4"	6 1/2	10"	\$549.99
	535720289	6.5 Creedmoor	3	20"	39 1/4"	13"	1/2"	3/4"	6 1/2	8"	549.99
	535720218	7mm-08 Rem	3	20"	39 1/4"	13"	1/2"	3/4"	6 1/2	9 1/2"	549.99
	535720220	308 Win	3	20"	39 1/4"	13"	1/2"	3/4"	6 1/2	12"	549.99
<b>NEW</b>	535720296	350 Legend	3	20"	39 1/4"	13"	1/2"	3/4"	6 3/4	10"	549.99
	535720264	270 WSM	3	22"	41 1/4"	13"	1/2"	3/4"	6 3/4	10"	549.99
	535720255	300 WSM	3	22"	41 1/4"	13"	1/2"	3/4"	6 3/4	10"	549.99
	535720277	325 WSM	3	22"	41 1/4"	13"	1/2"	3/4"	6 3/4	10"	549.99

(SCOPE AND MOUNTS SHOWN NOT INCLUDED.)



# SPORTER



- **M.O.A. TRIGGER SYSTEM** with zero take-up, zero creep and zero overtravel gives you outstanding accuracy
- **BOLT UNLOCK BUTTON** allows the chamber to be unloaded with the thumb safety in the on safe position
- **NICKEL TEFLON®** on the bolt body offers smoother operation and added corrosion resistance
- **DETACHABLE BOX MAGAZINE** is a single stack design constructed from a rugged polymer for greater reliability
- **CLOSE-GRAINED GRADE I WALNUT STOCK** with crisp checkering on the pistol grip and fore-end. The flattened fore-end profile improves stability from sandbags or a benchrest
- **PERMA-COTE™ MATTE BLACK METAL SURFACES** minimize glare to help prevent game-spooking reflections and protect from corrosion

- **INFLEX TECHNOLOGY RECOIL PAD** directs energy down and away from your cheek to reduce felt recoil
- **STEEL RECOIL LUG** is inletted into the stock to prevent the receiver from twisting under recoil for more reliable and predictable long-range accuracy
- **RECEIVER IS MACHINED FROM SOLID STEEL BAR STOCK** and through-hardened during heat treating for longer life and enhanced accuracy
- **TWO-POSITION THUMB SAFETY** and a cocking indicator show the XPR® rifle's safety status at a glance or by feel
- **BUTTON-RIFLED, FREE-FLOATED STEEL BARREL** is thermally stress-relieved then precisely aligned and headspaced during assembly via the barrel nut
- **RECESSED TARGET CROWN** protects the muzzle rifling from wear and impact damage to help maintain greater accuracy



# XPR® & COMPACT



- **M.O.A. TRIGGER SYSTEM** with zero take-up, zero creep and zero overtravel gives you outstanding accuracy
- **BOLT UNLOCK BUTTON** allows the chamber to be unloaded with the thumb safety in the on safe position
- **NICKEL TEFLON®** on the bolt body offers smoother operation and added corrosion resistance
- **DETACHABLE BOX MAGAZINE** is a single stack design constructed from a rugged polymer for greater reliability
- **ADVANCED POLYMER STOCK** with textured panels help improve wet weather grip. The flattened fore-end profile improves stability from sandbags or a benchrest
- **SHORTER 13" LENGTH OF PULL ON COMPACT** makes it perfect for younger shooters and those of smaller stature
- **PERMA-COTE™ MATTE FINISH ON THE BARREL, RECEIVER AND BOLT HANDLE** minimizes glare to help prevent game-spooking reflections and protects these parts from corrosion. Full-size guns are matte black and compact models are dark gray

- **INFLEX TECHNOLOGY RECOIL PAD** directs energy down and away from your cheek to reduce felt recoil. The XPR® Compact is fitted with a plush Pachmayr® Decelerator® recoil pad
- **STEEL RECOIL LUG** is inletted into the stock to prevent the receiver from twisting under recoil for more reliable and predictable long-range accuracy
- **RECEIVER IS MACHINED FROM SOLID STEEL BAR STOCK** and through-hardened during heat treating for longer life and enhanced accuracy
- **TWO-POSITION THUMB SAFETY** and a cocking indicator show the XPR® rifle's safety status at a glance or by feel
- **BUTTON-RIFLED, FREE-FLOATED STEEL BARREL** is thermally stress-relieved then precisely aligned and headspaced during assembly via the barrel nut
- **RECESSED TARGET CROWN** protects the muzzle rifling from wear and impact damage to help maintain greater accuracy

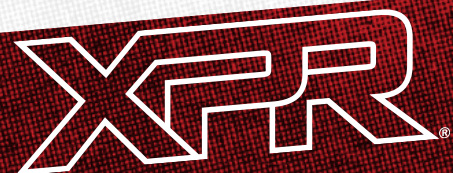

# MODEL 70<sup>®</sup>

**FORGED IN THE FIRES OF GUNMAKING HISTORY, THE RIFLEMAN'S RIFLE IS THE LEGENDARY BENCHMARK AGAINST WHICH ALL OTHERS ARE MEASURED.**  
 Words like iconic, passion, loyalty, reverence and dedication are not often used when describing rifles. But no other bolt-action in history has secured a following among avid riflemen like the Model 70<sup>®</sup>. Since its introduction in 1936 none have ever been considered the equal of this legendary long gun.



**STAINLESS STEEL COMPONENTS**  
 The trigger housing and all internal components of the M.O.A. Trigger System are constructed of durable, corrosion-resistant stainless steel.

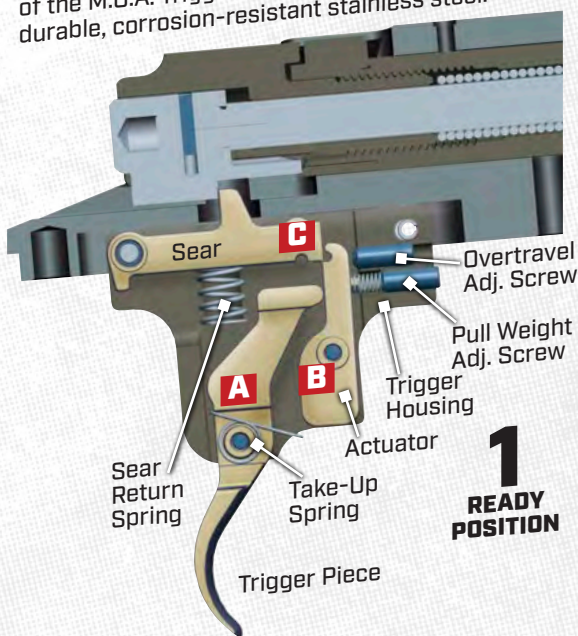

**[1] M.O.A. TRIGGER SYSTEM**

The Model 70<sup>®</sup> rifle's M.O.A. Trigger System works on the simple principle of the pivoting lever. Pictured above are the trigger piece (A), actuator (B), and sear (C). The housing and all internal parts, pins and springs are precision crafted from stainless steel. In addition, the sear and actuator are coated with Slick Shot<sup>®</sup> electroless nickel Teflon<sup>®</sup> for corrosion resistance and smoother operation.

**[2] 2:1 MECHANICAL ADVANTAGE**

The M.O.A.'s trigger piece offers a wide, smooth face to better distribute finger pressure for a lighter, more sensitive feel. Because of its geometry and 2:1 mechanical advantage, the trigger piece travels only half the distance of the actuator (2X). Since this distance is cut in half, the perception of creep and overtravel are virtually eliminated.

**ZERO TAKE-UP**

Take-up is the distance the trigger piece travels prior to the sear moving toward release and the shooter feeling resistance. The M.O.A. Trigger System uses a spring to eliminate take-up by keeping the trigger piece in constant contact with the actuator. Unlike competitors' designs, the unique geometry of the M.O.A. pre-loads the entire trigger system to bias out normal manufacturing tolerances.

**ZERO CREEP**

Creep is the perceptible movement of the trigger prior to the release of the firing pin and has a negative influence on accuracy, causing inconsistency and uncertainty during the pull of the trigger. Creep contributes to jerking the trigger, thus adding to movement of the gun during firing. The 2:1 mechanical advantage created by the M.O.A. Trigger's unique design geometry has virtually eliminated creep in the Model 70<sup>®</sup> M.O.A. Trigger.

**ZERO OVERTRAVEL**

Overtravel is the rearward movement of the trigger after the firing pin has been released. It can actually jar the gun away from its intended point of aim and is very distracting to the shooter. The Model 70<sup>®</sup> M.O.A. Trigger System is set at the factory to have no perceptible overtravel. When the sear drops, the trigger stops. Where you aim is where you shoot.

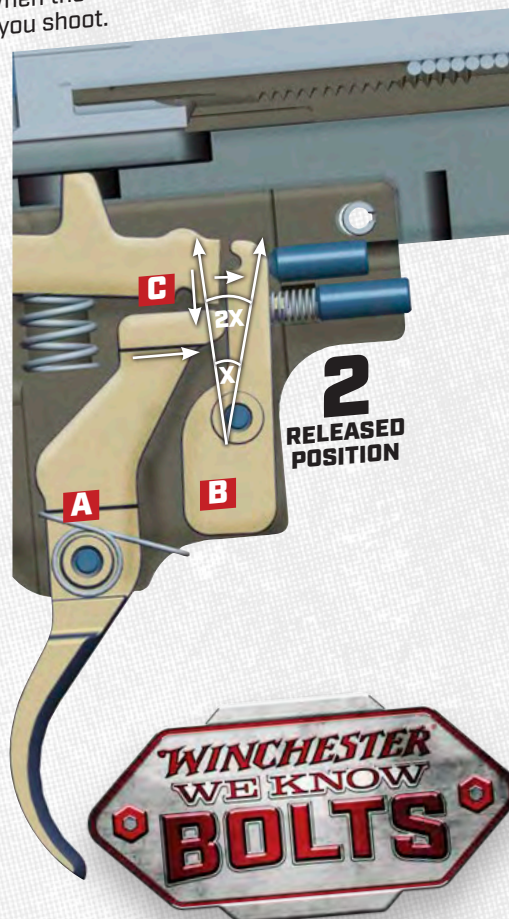



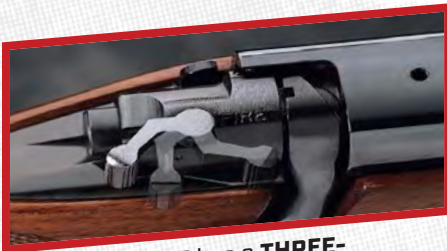

Every Model 70® has a **THREE-POSITION SAFETY** that is convenient to operate with the thumb of your firing hand. The design retracts the firing pin away from the sear. When the safety selector is in the middle position, the action can still be operated, allowing unfired cartridges to be cycled with the safety on. It's smooth to engage and easily identifies, by sight and feel, the safety status of the rifle.



A **BLADE-TYPE EJECTOR** gives you full control when ejecting a fired case. Pull the bolt back slowly and the empty case pops out gently — perfect for target shooters and varminters. Pull the bolt back sharply and the empty case clears the port with greater force.



If there were a single feature responsible for the Model 70® rifle being labeled the "Bolt-Action Rifle of the Century," it would be the classic Pre-'64 style **CONTROLLED ROUND FEED AND CLAW EXTRACTOR (CRF)** bolt design. The massive claw extractor secures the cartridge's base, exerting full control from the very moment it leaves the magazine and enters the chamber, gripping it tightly until it's fully ejected. This time-proven design allows an unfired cartridge to be extracted even if it is not yet fully chambered.



The trigger guard and magazine frame of each Model 70® rifle feature a solid, **ONE-PIECE BOTTOM METAL** supporting the action through the magazine well. This added rigidity contributes to accuracy and integrity better than two-piece systems. The hinged magazine floorplate speeds unloading of the cartridges to avoid having to cycle them through the action. The action and trigger guard are held in place by stout hex head screws.



You can expect **1 MDA ACCURACY** for three-shot groups from your Model 70® rifle using high-quality ammo and optics under suitable weather and range conditions.



Critical to rifle accuracy is how the barrel is made and set in the stock. Model 70® barrels have a reputation for delivering top accuracy, even during the heat of long strings of fire. Every precision rifled Model 70 barrel is **FREE-FLOATING** in the stock so that no part of the fore-end touches the barrel, because pressure from contacting the stock adversely influences accuracy.

**THE STEEL RECEIVER IS FORGED** for superior material properties. Each forging is precision machined to create a strong, stiff and solid receiver that resists flexing and delivers top accuracy over a lifetime of shooting. The bottom profile of the Model 70® receiver is flat to offer more surface area for bedding. It's then bedded at the front and rear to eliminate shifts in zero and preserve pinpoint accuracy. The flat bottom contour also resists twisting inside the stock during firing, making it superior to the competitors' round bottom receivers.

**THE INTEGRAL RECOIL LUG** on the Model 70® is actually forged and machined as part of the receiver. It's a hefty block of solid steel, not a mere washer or tab that's just sandwiched between the barrel and the action during assembly. This allows the barrel to be trued in perfect alignment to the front ring of the receiver for greater accuracy. There is nothing to move, settle or shift the barrel out of alignment, ever. It's what makes a Model 70 rifle shoot straight and true, year after year.

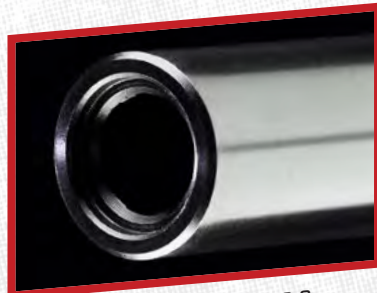

Every Model 70® features a **RECESSED TARGET CROWN** at the muzzle to protect the rifling from nicks and dings. Each bullet exits the barrel uniformly, with ultimate precision.



The **RECOIL PAD** on Model 70® rifles is a premium Pachmayr® Decelerator® recoil pad. This industry leading pad offers optimal protection against felt recoil.

# MODEL 70®

# REAL ICON.

IT'S EVERYTHING THE PERFECT HUNTING RIFLE SHOULD BE.



SHADOWLINE CHEEKPIECE



ONE-PIECE STEEL BOTTOM METAL

ITEM NUMBER	CALIBER	MAG CAP	BARREL LENGTH	OVERALL LENGTH	LENGTH OF PULL	DROP AT COMB	DROP AT HEEL	NOMINAL WT. (LBS)	RATE OF TWIST	SUGGESTED RETAIL
<b>MODEL 70 SUPER GRADE</b>										
<b>NEW</b> 535203289	6.5 Creedmoor	5	22"	42 1/4"	13 3/4"	1/2"	1/2"	7 3/4	8"	\$1,439.99
535203264	270 WSM	3	24"	44 1/4"	13 3/4"	1/2"	1/2"	8	10"	1,479.99
535203255	300 WSM	3	24"	44 1/4"	13 3/4"	1/2"	1/2"	8	10"	1,479.99
535203226	270 Win	5	24"	44 3/4"	13 3/4"	1/2"	1/2"	8 1/4	10"	1,439.99
535203228	30-06 Sprg	5	24"	44 3/4"	13 3/4"	1/2"	1/2"	8 1/4	10"	1,439.99
535203230	7mm Rem Mag	3	26"	46 3/4"	13 3/4"	1/2"	1/2"	8 1/2	9 1/2"	1,479.99
535203233	300 Win Mag	3	26"	46 3/4"	13 3/4"	1/2"	1/2"	8 1/2	10"	1,479.99
535203236	338 Win Mag	3	26"	46 3/4"	13 3/4"	1/2"	1/2"	8 1/2	10"	1,479.99
<b>MODEL 70 SPORTER</b>										
535202264	270 WSM	3	24"	44 1/4"	13 3/4"	1/2"	1/2"	7 1/4	10"	\$1,049.99
535202255	300 WSM	3	24"	44 1/4"	13 3/4"	1/2"	1/2"	7 1/4	10"	1,049.99
535202277	325 WSM	3	24"	44 1/4"	13 3/4"	1/2"	1/2"	7 1/4	10"	1,009.99
535202225	25-06 Rem	5	24"	44 3/4"	13 3/4"	1/2"	1/2"	7 1/4	10"	1,009.99
535202226	270 Win	5	24"	44 3/4"	13 3/4"	1/2"	1/2"	7 1/4	10"	1,009.99
535202228	30-06 Sprg	5	24"	44 3/4"	13 3/4"	1/2"	1/2"	7 3/4	9"	1,049.99
535202229	264 Win Mag	3	26"	46 3/4"	13 3/4"	1/2"	1/2"	7 3/4	9 1/2"	1,049.99
535202230	7mm Rem Mag	3	26"	46 3/4"	13 3/4"	1/2"	1/2"	7 3/4	10"	1,049.99
535202233	300 Win Mag	3	26"	46 3/4"	13 3/4"	1/2"	1/2"	7 3/4	10"	1,049.99
535202236	338 Win Mag	3	26"	46 3/4"	13 3/4"	1/2"	1/2"	7 3/4	10"	1,049.99

(SCOPE AND MOUNTS SHOWN NOT INCLUDED.)



# SUPER GRADE



- **GRADE IV/V FULL FANCY WALNUT STOCK WITH SHADOWLINE CHEEKPIECE** places your eye in perfect alignment with the scope
- **HIGHLY POLISHED METAL SURFACES** add style and elegance
- **ONE-PIECE STEEL BOTTOM METAL WITH STEEL FLOORPLATE** adds rigidity for better accuracy
- **ENGRAVED STEEL CROSSBOLT** adds strength, rigidity and a touch of stylish refinement
- **INLETTED SLING SWIVEL STUDS** allow you to attach your favorite sling
- **FORGED STEEL RECEIVER WITH INTEGRAL RECOIL LUG** is bedded front and rear to eliminate shifts in zero for exceptional long-range accuracy
- **PRE-'64 STYLE CONTROLLED ROUND FEED WITH CLAW EXTRACTOR** fully controls the cartridge from magazine, to chamber, to ejection

- **THREE-POSITION SAFETY** allows you to unload the chamber while on safe and shows safety status at a glance
- **FREE-FLOATING BARREL** for years of pinpoint accuracy
- **RECESSED TARGET CROWN** enhances accuracy and protects the rifling
- **M.O.A. TRIGGER SYSTEM** with zero take-up, zero creep and zero overtravel gives you outstanding accuracy
- **BLADE-TYPE EJECTOR** for full control of ejection force
- **PACHMAYR® DECELERATOR® RECOIL PAD** for optimal protection against felt recoil



RAISED CHEEKPIECE



# SPORTER



- **SATIN FINISH GRADE I WALNUT STOCK WITH CUT CHECKERING AND DELUXE CHEEKPIECE** places your eye in perfect alignment with the scope
- **POLISHED METAL SURFACES** add style and elegance
- **STEEL SLING SWIVEL STUDS** allow you to attach your favorite sling
- **ONE-PIECE ALLOY BOTTOM METAL** adds rigidity for better accuracy
- **FORGED STEEL RECEIVER WITH INTEGRAL RECOIL LUG** is bedded front and rear to eliminate shifts in zero for exceptional long-range accuracy
- **PRE-'64 STYLE CONTROLLED ROUND FEED WITH CLAW EXTRACTOR** fully controls the cartridge from magazine, to chamber, to ejection

- **THREE-POSITION SAFETY** allows you to unload the chamber while on safe and shows safety status at a glance
- **FREE-FLOATING BARREL** for years of pinpoint accuracy
- **RECESSED TARGET CROWN** enhances accuracy and protects the rifling
- **M.O.A. TRIGGER SYSTEM** with zero take-up, zero creep and zero overtravel gives you outstanding accuracy
- **BLADE-TYPE EJECTOR** for full control of ejection force
- **PACHMAYR® DECELERATOR® RECOIL PAD** for optimal protection against felt recoil

MODEL 70®

# LIFESAVERS.

THE RELIABLE RIFLES YOU CAN TRUST WITH YOUR LIFE FOR THAT ONCE-IN-A-LIFETIME HUNT FOR THE WORLD'S MOST DANGEROUS BIG GAME.



"...IN THE PURSUIT OF DANGEROUS GAME THINGS HAPPEN QUICKLY AND UNPREDICTABLY. A CONTROLLED ROUND FEED RIFLE...MEANS (I HAVE) ONE LESS THING TO WORRY ABOUT IN THE HEAT OF THE MOMENT."  
 — Casey Keefer



ITEM NUMBER	CALIBER	MAG CAP	BARREL LENGTH	OVERALL LENGTH	LENGTH OF PULL	DROP AT COMB	DROP AT HEEL	SIGHT RADIUS	NOMINAL WT. (LBS)	RATE OF TWIST	SUGGESTED RETAIL
<b>MODEL 70 SAFARI EXPRESS</b>											
535204161	375 H&H Mag	3	24"	44 3/4"	13 3/4"	1/2"	1/2"	18"	9	12"	\$1,559.99
535204139	416 Rem Mag	3	24"	44 3/4"	13 3/4"	1/2"	1/2"	18"	9	14"	1,559.99
535204144	458 Win Mag	3	24"	44 3/4"	13 3/4"	1/2"	1/2"	18"	9	14"	1,559.99

**DUAL RECOIL LUGS ON THE SAFARI EXPRESS**

**DELUXE CHEEKPIECE ON THE SAFARI EXPRESS**

**DUAL CROSS BOLTS ON THE SAFARI EXPRESS**

# SAFARI EXPRESS



- **SATIN FINISH GRADE I WALNUT STOCK WITH CUT CHECKERING AND DELUXE CHEEKPIECE** places your eye in perfect alignment with open sights or a scope
- **ONE-PIECE STEEL BOTTOM METAL WITH STEEL FLOORPLATE** adds rigidity for better accuracy
- **MATTE FINISHED METAL SURFACES** reduce glare
- **DUAL STEEL CROSSBOLTS** add strength, rigidity and a touch of stylish refinement
- **FORGED STEEL RECEIVER WITH DUAL RECOIL LUGS** is bedded front and rear to eliminate shifts in zero for exceptional long-range accuracy
- **PRE-'64 STYLE CONTROLLED ROUND FEED WITH CLAW EXTRACTOR** fully controls the cartridge from magazine, to chamber, to ejection

- **THREE-POSITION SAFETY** allows you to unload the chamber while on safe and shows safety status at a glance
- **FREE-FLOATING BARREL** for years of pinpoint accuracy
- **FULLY ADJUSTABLE REAR SIGHT AND HOODED BRASS BEAD FRONT** get you on target quickly
- **BARREL-MOUNTED FRONT SLING SWIVEL** adds a classic touch
- **RECESSED TARGET CROWN** enhances accuracy and protects the rifling
- **M.O.A. TRIGGER SYSTEM** with zero take-up, zero creep and zero overtravel gives you outstanding accuracy
- **BLADE-TYPE EJECTOR** for full control of ejection force
- **PACHMAYR® DECELERATOR® RECOIL PAD** for optimal protection against felt recoil

# ALASKAN



- **SATIN FINISH MONTE CARLO WALNUT STOCK WITH CUT CHECKERING** places your eye in perfect alignment with open sights or a scope
- **ONE-PIECE ALLOY BOTTOM METAL** adds rigidity for better accuracy
- **POLISHED METAL SURFACES** add style and elegance
- **FORGED STEEL RECEIVER WITH INTEGRAL RECOIL LUG** is bedded front and rear to eliminate shifts in zero for exceptional long-range accuracy
- **PRE-'64 STYLE CONTROLLED ROUND FEED WITH CLAW EXTRACTOR** fully controls the cartridge from magazine, to chamber, to ejection

- **THREE-POSITION SAFETY** allows you to unload the chamber while on safe and shows safety status at a glance
- **FREE-FLOATING BARREL** for years of pinpoint accuracy
- **RECESSED TARGET CROWN** enhances accuracy and protects the rifling
- **FOLDING ADJUSTABLE REAR SIGHT AND HOODED BRASS BEAD FRONT** get you on target quickly
- **M.O.A. TRIGGER SYSTEM** with zero take-up, zero creep and zero overtravel gives you outstanding accuracy
- **BLADE-TYPE EJECTOR** for full control of ejection force
- **PACHMAYR® DECELERATOR® RECOIL PAD** for optimal protection against felt recoil



**ADJUSTABLE FOLDING REAR SIGHT ON BARREL BOSS**

ITEM NUMBER	CALIBER	MAG CAP	BARREL LENGTH	OVERALL LENGTH	LENGTH OF PULL	DROP AT COMB	DROP AT HEEL	SIGHT RADIUS	NOMINAL WT. (LBS)	RATE OF TWIST	SUGGESTED RETAIL
<b>MODEL 70 ALASKAN</b>											
535205128	30-06 Sprg	5	25"	45 3/4"	13 3/4"	5/8"	5/8"	18 1/2"	8 1/2"	10"	\$1,399.99
535205133	300 Win Mag	3	25"	45 3/4"	13 3/4"	5/8"	5/8"	18 1/2"	8 1/2"	10"	1,399.99
535205136	338 Win Mag	3	25"	45 3/4"	13 3/4"	5/8"	5/8"	18 1/2"	8 1/2"	10"	1,399.99
535205138	375 H&H Mag	3	25"	45 3/4"	13 3/4"	5/8"	5/8"	18 1/2"	8 1/2"	12"	1,439.99

\*DROP AT MONTE CARLO IS 2".

# MODEL 70®

19

# MODEL 70®

# FANTASTIC CLASSICS.

NO OTHER MODEL 70® EMBODIES THE ESSENTIAL SPIRIT OF THE HUNT LIKE THE CLASSIC FEATHERWEIGHT.



## FEATHERWEIGHT COMPACT



- **SATIN FINISH WALNUT STOCK WITH CLASSIC FEATHERWEIGHT CUT CHECKERING AND SCHNABEL FORE-END** create the iconic Featherweight look
- **SHORTER 13" LENGTH OF PULL** makes it perfect for younger shooters or those of smaller stature
- **POLISHED METAL SURFACES** add style and elegance
- **ONE-PIECE ALLOY BOTTOM METAL** adds rigidity for better accuracy
- **FORGED STEEL SHORT ACTION RECEIVER WITH INTEGRAL RECOIL LUG** is bedded front and rear to eliminate shifts in zero for exceptional long-range accuracy

- **PRE-'64 STYLE CONTROLLED ROUND FEED WITH CLAW EXTRACTOR** fully controls the cartridge from magazine, to chamber, to ejection
- **THREE-POSITION SAFETY** allows you to unload the chamber while on safe and shows safety status at a glance
- **20" FREE-FLOATING FEATHERWEIGHT PROFILE BARREL** for years of pinpoint accuracy
- **RECESSED TARGET CROWN** enhances accuracy and protects the rifling
- **M.O.A. TRIGGER SYSTEM** with zero take-up, zero creep and zero overtravel gives you outstanding accuracy
- **BLADE-TYPE EJECTOR** for full control of ejection force
- **PACHMAYR® DECELERATOR® RECOIL PAD** for optimal protection against felt recoil



**"I'M ABSOLUTELY IN LOVE WITH MY WINCHESTER® MODEL 70®. ITS LIGHTWEIGHT DESIGN AND INCREDIBLE ACCURACY MAKE IT THE ULTIMATE RIFLE FOR ANY SERIOUS WHITETAILER. I OWN TWO MODEL 70S CHAMBERED IN 243 WINCHESTER, AND OFTEN I CAN'T DECIDE WHICH ONE TO PICK UP WHEN I GO AFIELD. TIME AND AGAIN I FIND MYSELF GRABBING THE WALNUT STOCK VERSION, AND IT HAS NEVER LET ME DOWN!"**  
 — Terry Drury • Drury Outdoors



# FEATHERWEIGHT



- **SATIN FINISH WALNUT STOCK WITH CLASSIC FEATHERWEIGHT CUT CHECKERING AND SCHNABEL FORE-END** create the iconic Featherweight look
- **POLISHED METAL SURFACES** add style and elegance
- **ONE-PIECE ALLOY BOTTOM METAL** adds rigidity for better accuracy
- **FORGED STEEL RECEIVER WITH INTEGRAL RECOIL LUG** is bedded front and rear to eliminate shifts in zero for exceptional long-range accuracy
- **PRE-'64 STYLE CONTROLLED ROUND FEED WITH CLAW EXTRACTOR** fully controls the cartridge from magazine, to chamber, to ejection

- **THREE-POSITION SAFETY** allows you to unload the chamber while on safe and shows safety status at a glance
- **FREE-FLOATING FEATHERWEIGHT PROFILE BARREL** for years of pinpoint accuracy
- **RECESSED TARGET CROWN** enhances accuracy and protects the rifling
- **M.O.A. TRIGGER SYSTEM** with zero take-up, zero creep and zero overtravel gives you outstanding accuracy
- **BLADE-TYPE EJECTOR** for full control of ejection force
- **PACHMAYR® DECELERATOR® RECOIL PAD** for optimal protection against felt recoil

(SCOPE AND MOUNTS SHOWN NOT INCLUDED.)

	ITEM NUMBER	CALIBER	MAG CAP	BARREL LENGTH	OVERALL LENGTH	LENGTH OF PULL	DROP AT COMB	DROP AT HEEL	NOMINAL WT. (LBS)	RATE OF TWIST	SUGGESTED RETAIL
<b>MODEL 70 FEATHERWEIGHT</b>											
	535200210	22-250 Rem	5	22"	42 1/4"	13 3/4"	1/2"	3/4"	6 3/4	14"	\$1,009.99
	535200212	243 Win	5	22"	42 1/4"	13 3/4"	1/2"	3/4"	6 3/4	10"	1,009.99
<b>NEW</b>	535200289	6.5 Creedmoor	5	22"	42 1/4"	13 3/4"	1/2"	3/4"	6 3/4	8"	1,009.99
	535200218	7mm-08 Rem	5	22"	42 1/4"	13 3/4"	1/2"	3/4"	6 3/4	9 1/2"	1,009.99
	535200220	308 Win	5	22"	42 1/4"	13 3/4"	1/2"	3/4"	6 3/4	12"	1,009.99
	535200220	270 WSM	3	24"	44 1/4"	13 3/4"	1/2"	3/4"	7	10"	1,049.99
	535200264	300 WSM	3	24"	44 1/4"	13 3/4"	1/2"	3/4"	7	10"	1,049.99
	535200255	325 WSM	3	24"	44 1/4"	13 3/4"	1/2"	3/4"	7	10"	1,009.99
	535200277	25-06 Rem	5	22"	42 3/4"	13 3/4"	1/2"	3/4"	7	10"	1,009.99
	535200225	270 Win	5	22"	42 3/4"	13 3/4"	1/2"	3/4"	7	10"	1,009.99
	535200226	30-06 Sprg	5	22"	42 3/4"	13 3/4"	1/2"	3/4"	7 1/4	9"	1,049.99
	535200228	284 Win Mag	3	24"	44 3/4"	13 3/4"	1/2"	3/4"	7 1/4	10"	1,049.99
	535200229	300 Win Mag	3	24"	44 3/4"	13 3/4"	1/2"	3/4"	7 1/4	10"	1,049.99
	535200233	300 Win Mag	3	24"	44 3/4"	13 3/4"	1/2"	3/4"	7 1/4	10"	1,049.99
<b>MODEL 70 FEATHERWEIGHT COMPACT</b>											
	535201210	22-250 Rem	5	20"	39 1/2"	13"	1/2"	3/4"	6 1/2	14"	\$1,009.99
	535201212	243 Win	5	20"	39 1/2"	13"	1/2"	3/4"	6 1/2	10"	1,009.99
<b>NEW</b>	535201289	6.5 Creedmoor	5	20"	39 1/2"	13"	1/2"	3/4"	6 1/2	8"	1,009.99
	535201218	7mm-08 Rem	5	20"	39 1/2"	13"	1/2"	3/4"	6 1/2	9 1/2"	1,009.99
	535201220	308 Win	5	20"	39 1/2"	13"	1/2"	3/4"	6 1/2	12"	1,009.99

# MODEL 70®

# TAKEN TO EXTREMES.

THESE RUGGED RIFLES HAVE WHAT IT TAKES TO HANDLE THE HARSHTEST OF HUNTS.



The Extreme Weather SS has a **SCULPTED CHEEKPIECE** that's beautifully functional, placing your eye in perfect alignment behind a scope.



### CROSS SECTION OF STOCK WITH ALUMINUM BEDDING BLOCK



### TOP VIEW OF ALUMINUM BEDDING BLOCK



A **ONE-PIECE ALUMINUM BEDDING BLOCK** in the Extreme Weather SS and the Coyote Light is molded right into the stock during manufacturing, providing a solid, rigid base that ensures flat-out reliability. The rifle holds a tight zero, placing every shot where you aim — dead on, in any weather condition, in any season.



### TIME TO GET EXTREME ON PREDATORS

Winchester® Varmint X® ammo is designed to devastate predators. Able to deliver extreme accuracy at extended ranges, the polymer tip bullet offers instant expansion for explosive terminal performance.



ITEM NUMBER	CALIBER	MAG CAP	BARREL LENGTH	OVERALL LENGTH	LENGTH OF PULL	DROP AT COMB	DROP AT HEEL	NOMINAL WT. (LBS)	RATE OF TWIST	SUGGESTED RETAIL
<b>MODEL 70 EXTREME WEATHER SS</b>										
<b>NEW</b> 535206212	243 Win	5	22"	42 1/4"	13 3/4"	1/2"	1/2"	6 3/4	10"	\$1,339.99
535206289	6.5 Creedmoor	5	22"	42 1/4"	13 3/4"	1/2"	1/2"	6 3/4	8"	1,339.99
535206218	7mm-08 Rem	5	22"	42 1/4"	13 3/4"	1/2"	1/2"	6 3/4	9 1/2"	1,339.99
535206220	308 Win	5	22"	42 1/4"	13 3/4"	1/2"	1/2"	6 3/4	12"	1,379.99
535206264	270 WSM	3	24"	44 1/4"	13 3/4"	1/2"	1/2"	7	10"	1,379.99
535206255	300 WSM	3	24"	44 1/4"	13 3/4"	1/2"	1/2"	7	10"	1,379.99
535206277	325 WSM	3	24"	44 1/4"	13 3/4"	1/2"	1/2"	7 1/8	10"	1,339.99
535206225	25-06 Rem	5	22"	42 3/4"	13 3/4"	1/2"	1/2"	7 1/8	10"	1,339.99
535206226	270 Win	5	22"	42 3/4"	13 3/4"	1/2"	1/2"	7 1/8	10"	1,379.99
535206228	30-06 Sprg	5	22"	42 3/4"	13 3/4"	1/2"	1/2"	7 1/4	9"	1,379.99
535206229	264 Win Mag	3	26"	46 3/4"	13 3/4"	1/2"	1/2"	7 1/4	9 1/2"	1,379.99
535206230	264 Win Mag	3	26"	46 3/4"	13 3/4"	1/2"	1/2"	7 1/4	10"	1,379.99
535206233	7mm Rem Mag	3	26"	46 3/4"	13 3/4"	1/2"	1/2"	7 1/4	10"	1,379.99
535206233	300 Win Mag	3	26"	46 3/4"	13 3/4"	1/2"	1/2"	7 1/4	10"	1,379.99
535206236	338 Win Mag	3	26"	46 3/4"	13 3/4"	1/2"	1/2"	7 1/4	10"	1,379.99

(SCOPE AND MOUNTS SHOWN NOT INCLUDED.)





## EXTREME WEATHER SS



- **BELL AND CARLSON™ SYNTHETIC STOCK WITH SCULPTED CHEEKPIECE** has a charcoal gray textured finish
- **ONE-PIECE ALUMINUM BEDDING BLOCK** adds strength and rigidity to maintain a reliable zero under adverse conditions
- **MATTE FINISHED METAL SURFACES** help reduce glare
- **ONE-PIECE ALLOY BOTTOM METAL** adds rigidity for better accuracy
- **FORGED STEEL RECEIVER WITH INTEGRAL RECOIL LUG** is bedded front and rear to eliminate shifts in zero for exceptional long-range accuracy
- **PRE-'64 STYLE CONTROLLED ROUND FEED WITH CLAW EXTRACTOR** fully controls the cartridge from magazine, to chamber, to ejection

- **THREE-POSITION SAFETY** allows you to unload the chamber while on safe and shows safety status at a glance
- **SPORTER WEIGHT STAINLESS STEEL, FREE-FLOATING FLUTED BARREL** reduces weight and improves cooling
- **RECESSED TARGET CROWN** enhances accuracy and protects the rifling
- **M.O.A. TRIGGER SYSTEM** with zero take-up, zero creep and zero overtravel gives you outstanding accuracy
- **BLADE-TYPE EJECTOR** for full control of ejection force
- **PACHMAYR® DECELERATOR® RECOIL PAD** for optimal protection against felt recoil



## COYOTE LIGHT SR



- **BELL AND CARLSON™ SYNTHETIC STOCK** has a charcoal gray textured finish and multiple fore-end vents
- **ONE-PIECE ALUMINUM BEDDING BLOCK** adds strength and rigidity to maintain a reliable zero under adverse conditions
- **MATTE FINISHED METAL SURFACES** help reduce glare
- **ONE-PIECE ALLOY BOTTOM METAL** adds rigidity for better accuracy
- **DUAL FRONT SLING SWIVEL STUDS** for sling and bipod
- **FORGED STEEL RECEIVER WITH INTEGRAL RECOIL LUG** is bedded front and rear to eliminate shifts in zero for exceptional long-range accuracy
- **PRE-'64 STYLE CONTROLLED ROUND FEED WITH CLAW EXTRACTOR** fully controls the cartridge from magazine, to chamber, to ejection

- **THREE-POSITION SAFETY** allows you to unload the chamber while on safe and shows safety status at a glance
- **MEDIUM HEAVY STAINLESS STEEL, FREE-FLOATING FLUTED BARREL** reduces weight and improves cooling
- **RECESSED TARGET CROWN** enhances accuracy and protects the rifling
- **THREADED MUZZLE (5/8" X 24 TPI)** readily accepts an optional sound suppressor, muzzle brake or other accessory. Thread protector collar included
- **M.O.A. TRIGGER SYSTEM** with zero take-up, zero creep and zero overtravel gives you outstanding accuracy
- **BLADE-TYPE EJECTOR** for full control of ejection force
- **PACHMAYR® DECELERATOR® RECOIL PAD** for optimal protection against felt recoil

ITEM NUMBER	CALIBER	MAG CAP	BARREL LENGTH	OVERALL LENGTH	LENGTH OF PULL	DROP AT COMB	DROP AT HEEL	NOMINAL WT. (LBS)	RATE OF TWIST	SUGGESTED RETAIL
<b>MODEL 70 COYOTE LIGHT SR</b>										
535232210	22-250 Rem	5	24"	44"	13 1/2"	1/2"	1/2"	7 1/2	14"	\$1,269.99
535232212	243 Win	5	24"	44"	13 1/2"	1/2"	1/2"	7 1/2	10"	1,269.99
<b>NEW</b> 535232289	6.5 Creedmoor	5	24"	44"	13 1/2"	1/2"	1/2"	7 1/2	12"	1,269.99
535232220	308 Win	5	24"	44"	13 1/2"	1/2"	1/2"	7 1/2	10"	1,309.99
535232264	270 WSM	3	24"	44"	13 1/2"	1/2"	1/2"	7 1/2	10"	1,309.99
535232255	300 WSM	3	24"	44"	13 1/2"	1/2"	1/2"	7 1/2	10"	1,309.99
535232277	325 WSM	3	24"	44"	13 1/2"	1/2"	1/2"	7 1/2	10"	1,309.99

(SCOPE AND MOUNTS SHOWN NOT INCLUDED.)



# THE REAL DEAL.

## THE LEGENDARY LEVER-ACTION RIFLES THAT BRING WESTERN HISTORY TO LIFE RIGHT IN YOUR OWN HANDS.

The history of the American West was made in a wild landscape where legend, myth, romance and reality rode side by side into the sunset. The rugged rifles made by Winchester Repeating Arms® were The Guns That Won the West. No other firearm brings the legacy of the Wild West to life like a real Winchester®.



The **MODEL 1866** was the very first rifle to wear the Winchester® brand. Its bright brass receiver was the basis for giving it the nickname of "Yellow Boy" and it became an instant favorite in the scabbards of cowboys and lawmen.

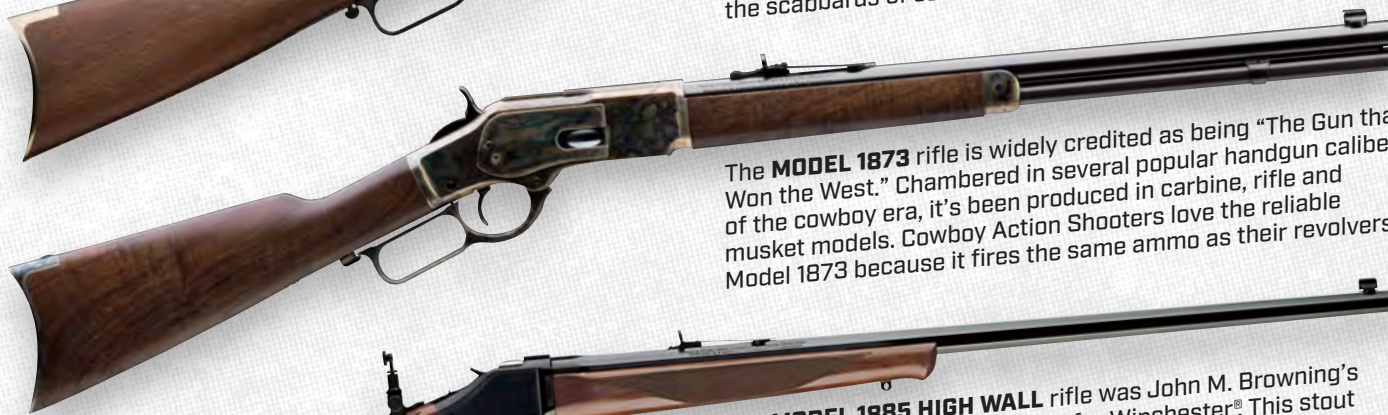

The **MODEL 1873** rifle is widely credited as being "The Gun that Won the West." Chambered in several popular handgun calibers of the cowboy era, it's been produced in carbine, rifle and musket models. Cowboy Action Shooters love the reliable Model 1873 because it fires the same ammo as their revolvers.



The **MODEL 1885 HIGH WALL** rifle was John M. Browning's first commercial firearm design for Winchester®. This stout falling-block action is so versatile it's been chambered in pistol cartridges up to the powerful belted magnums. It's remained the gold standard of single-shot rifles for more than 125 years.

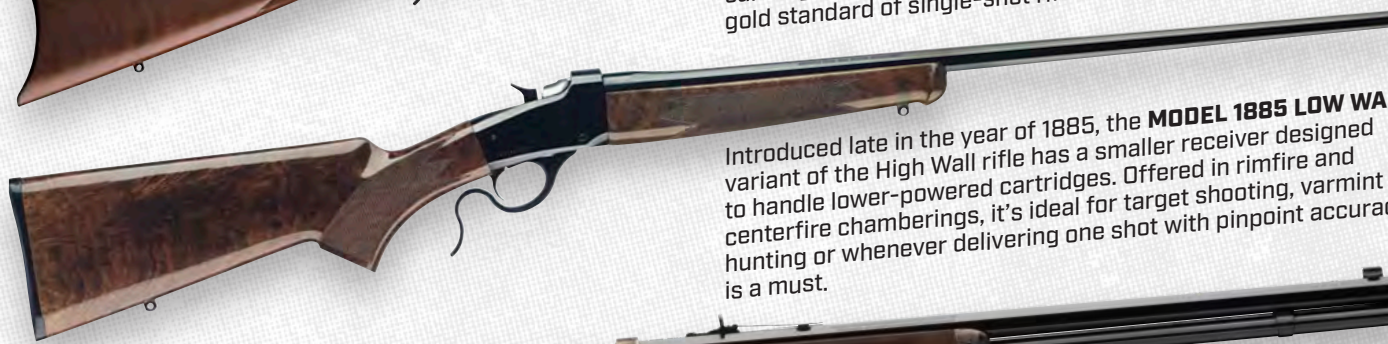

Introduced late in the year of 1885, the **MODEL 1885 LOW WALL** variant of the High Wall rifle has a smaller receiver designed to handle lower-powered cartridges. Offered in rimfire and centerfire chamberings, it's ideal for target shooting, varmint hunting or whenever delivering one shot with pinpoint accuracy is a must.



The **MODEL 1886** rifle was John M. Browning's second design for Winchester®. Robust and accurate, it's capable of handling the long, powerful black powder "buffalo" cartridges that were popular on the Western Plains. The 45-70 Government is the all-time classic chambering for this legendary rifle design.

Please note that these firearms are representative of the legendary guns that make up the Winchester Repeating Arms® Historic product line. They are made in limited quantities and will rotate in and out of production on an ongoing basis. **Thus not every gun shown here will be produced every year.** Available historic products for 2019 are shown on pages 26-41.



Winchester® historic rifles have long been offered with **TRADITIONAL BUTTPLATE DESIGNS** including a **CRESCENT METAL PLATE**, a **METAL CARBINE STRAP** and several variations of the classic flat **SHOTGUN BUTTPLATE**.



The **TRADITIONAL STRAIGHT GRIP** and **CURVED PISTOL GRIP** are two hallmarks of a genuine Winchester® rifle or carbine.

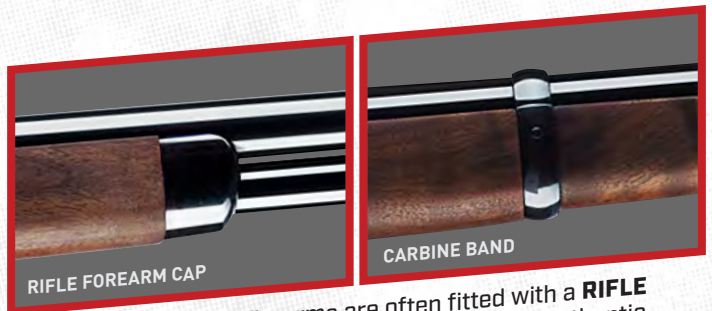

Classic Winchester® firearms are often fitted with a **RIFLE FOREARM CAP** or a **CARBINE BAND** to add that authentic touch every cowboy wants.

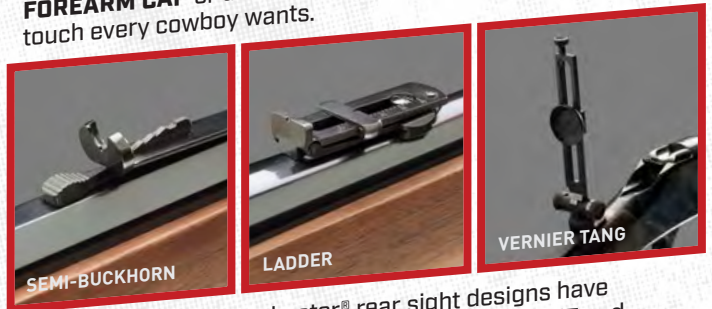

Over the decades Winchester® rear sight designs have included the **SEMI-BUCKHORN**, the **LADDER SIGHT** and the **VERNIER TANG** or **TANG PEEP SIGHT**.

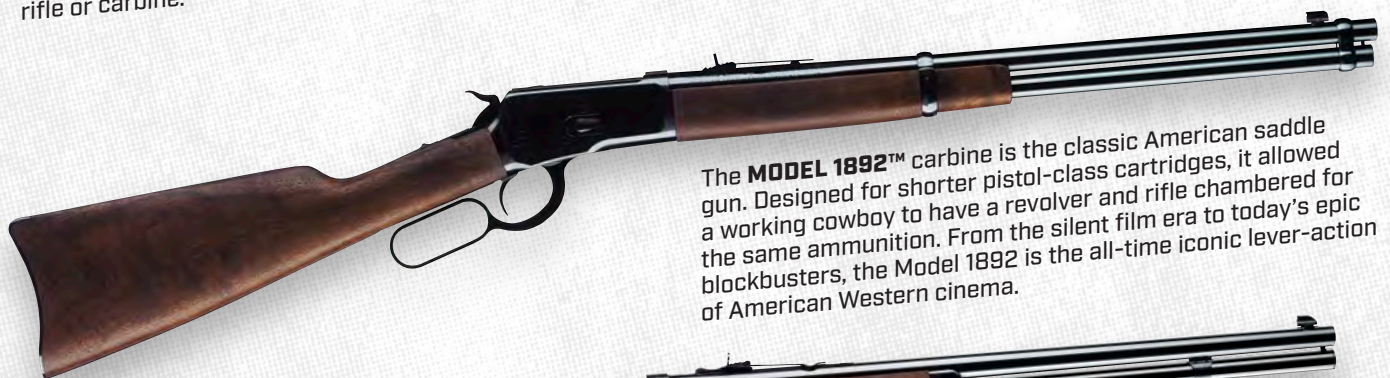

The **MODEL 1892™** carbine is the classic American saddle gun. Designed for shorter pistol-class cartridges, it allowed a working cowboy to have a revolver and rifle chambered for the same ammunition. From the silent film era to today's epic blockbusters, the Model 1892 is the all-time iconic lever-action of American Western cinema.

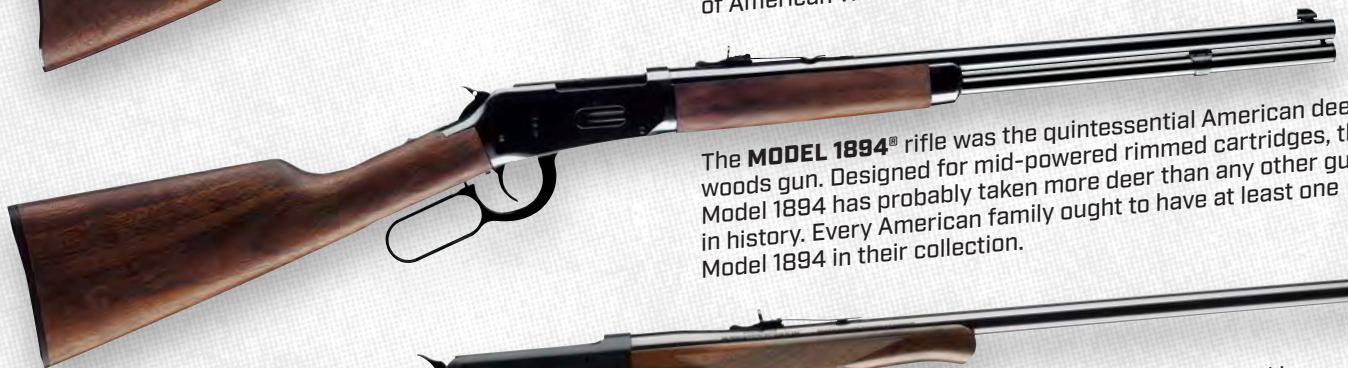

The **MODEL 1894®** rifle was the quintessential American deep woods gun. Designed for mid-powered rimmed cartridges, the Model 1894 has probably taken more deer than any other gun in history. Every American family ought to have at least one Model 1894 in their collection.



The **MODEL 1895®** rifle was designed with an internal box magazine, allowing the use of pointed bullets and the then-new bottleneck cartridges loaded with smokeless powder. Theodore Roosevelt called it his "Medicine Gun" and used it with great success on his 1909 African safari.



The **MODEL 71®** rifle is a modified version of the Model 1886 introduced by Winchester® in 1935. It's chambered for the robust 348 Winchester cartridge. Designed for taking deer, black bear and even moose, the Model 71 is also perfect for taking a trophy boar on your next wild hog hunt.

MODEL 1866

# YELLOW BOY.

THE GOLDEN RIFLE THAT STARTED THE WINCHESTER® LEGEND.

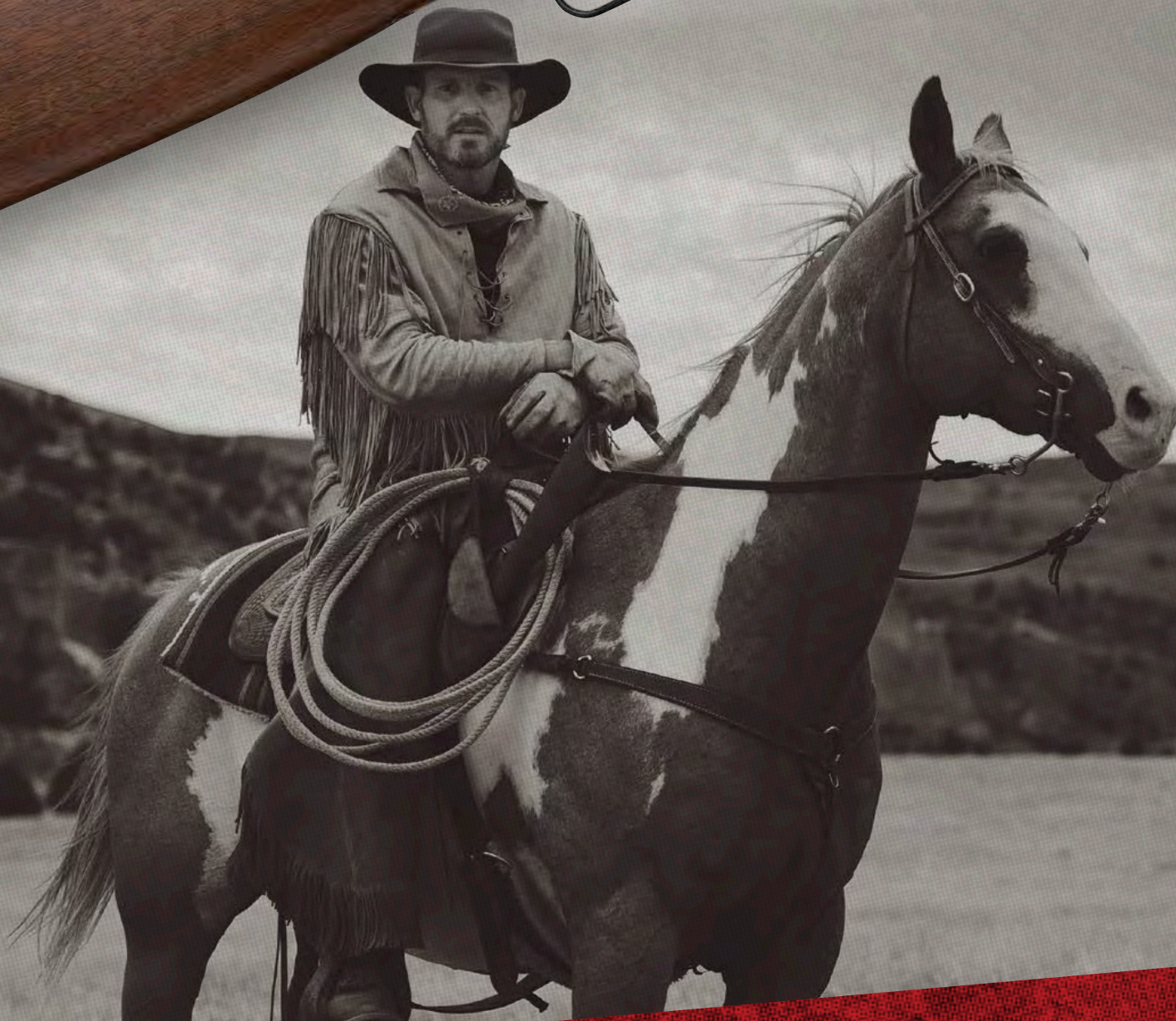

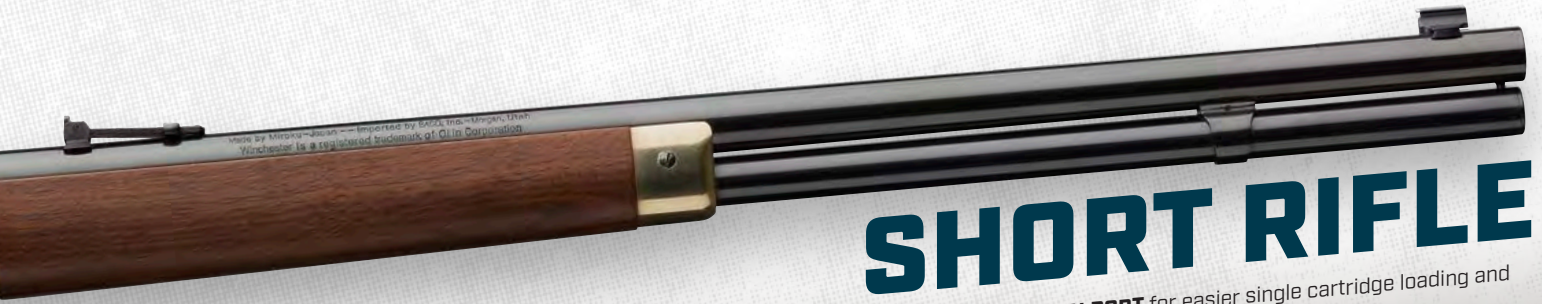

# SHORT RIFLE

- **GRADE I AMERICAN BLACK WALNUT STRAIGHT GRIP STOCK** with a satin oil finish that's velvet smooth to the touch
- **CLASSIC RIFLE-STYLE FOREARM** with polished brass forearm cap for the timeless look and feel of the original Model 1866
- **FULL BRIGHT POLISH** gives a deep, traditional glow to the brass receiver, crescent buttplate and forearm cap
- **CRESCENT BRASS BUTTPLATE** slips right into your shoulder for a more solid hold from any shooting position
- **FOLDING LADDER REAR SIGHT AND MARBLE ARMS® GOLD BEAD FRONT SIGHT** get you on target quickly

- **OPEN TOP EJECTION PORT** for easier single cartridge loading and smoother, more reliable ejection of fired cases
- **FULL-LENGTH MAGAZINE TUBE** aids in offhand balance and provides plenty of ammo capacity for hunting, competition and casual plinking
- **BLUED STEEL LOADING GATE** allows for smoother loading and adds a touch of contrast against the highly polished brass receiver
- **BLUED STEEL ACTION SCREWS** create an added touch of tasteful contrast against the surface of the polished brass receiver

ITEM NUMBER	CALIBER	MAG CAP	BARREL LENGTH	OVERALL LENGTH	LENGTH OF PULL	DROP AT COMB	DROP AT HEEL	NOMINAL WT. (LBS)	RATE OF TWIST	SUGGESTED RETAIL
<b>MODEL 1866 SHORT RIFLE</b>										
534244188	38 Spcl	11	20"	39"	13"	1 3/4"	3"	7 1/4	18 3/4"	\$1,299.99
534244140	44-40 Win	10	20"	39"	13"	1 3/4"	3"	7 1/4	36"	1,299.99
534244141	45 Colt	10	20"	39"	13"	1 3/4"	3"	7 1/4	26"	1,299.99

MODEL 1873

# COWBOY UP.

THESE ARE THE PERFECT COWBOY ACTION GUNS TO BRING THE WINCHESTER® LEGEND TO LIFE.



## SHORT RIFLE

- **WALNUT STRAIGHT GRIP STOCK** with a satin oil finish that's velvet smooth to the touch
- **CLASSIC RIFLE-STYLE FOREARM** with blued steel cap for the timeless look and feel of the original Model 1873
- **BLUED STEEL CRESCENT BUTTPLATE** slips into your shoulder for a solid hold

- **SEMI-BUCKHORN REAR SIGHT AND MARBLE ARMS® GOLD BEAD FRONT SIGHT** get you on target quickly
- **STEEL LOADING GATE** for smoother loading
- **BRASS CARTRIDGE LIFTER** for more reliable feeding, even during the heat of cowboy action competition
- **RECEIVER TOP TANG** is drilled and tapped for an optional tang-mounted rear sight for a more precise sight picture



TRADITIONAL DUST COVER

ULTRA-SMOOTH ACTION

BRASS CARTRIDGE LIFTER



# CARBINE

- **WALNUT STRAIGHT GRIP STOCK** with a satin oil finish that's velvet smooth to the touch
- **CLASSIC CARBINE-STYLE FOREARM** with a blued barrel band for the timeless look and feel of the original Model 1873 carbines
- **BLUED STEEL CARBINE STRAP BUTTPLATE** slips into your shoulder for a solid hold

- **BLUED STEEL CARBINE SADDLE RING** lets you secure your carbine to your saddle rigging
- **LADDER STYLE REAR SIGHT AND BLADE FRONT SIGHT** get you on target quickly
- **STEEL LOADING GATE** for smoother loading
- **RECEIVER TOP TANG** is drilled and tapped for an optional tang-mounted rear sight for a more precise sight picture



# SHORT RIFLE

COLOR CASE HARDENED

- **WALNUT STRAIGHT GRIP STOCK** with a satin oil finish that's velvet smooth to the touch
- **CLASSIC RIFLE-STYLE FOREARM** with color case hardened cap for the timeless look and feel of the original Model 1873
- **MAGNIFICENT COLOR CASE HARDENING** on the robust steel receiver
- **COLOR CASE HARDENED STEEL CRESCENT BUTTPLATE** slips into your shoulder for a solid hold

- **SEMI-BUCKHORN REAR SIGHT AND MARBLE ARMS® GOLD BEAD FRONT SIGHT** get you on target quickly
- **STEEL LOADING GATE** for smoother loading
- **RECEIVER TOP TANG** is drilled and tapped for an optional tang-mounted rear sight for a more precise sight picture

ITEM NUMBER	CALIBER	MAG CAP	BARREL LENGTH	OVERALL LENGTH	LENGTH OF PULL	DROP AT COMB	DROP AT HEEL	NOMINAL WT. (LBS)	RATE OF TWIST	SUGGESTED RETAIL
<b>MODEL 1873 CARBINE</b>										
534255137	357 Mag/38 Spl	10/11	20"	39"	13"	13/4"	3"	7 1/4	18 3/4"	\$1,299.99
534255140	44-40 Win	10	20"	39"	13"	13/4"	3"	7 1/4	36"	1,299.99
534255141	45 Colt	10	20"	39"	13"	13/4"	3"	7 1/4	26"	1,299.99
<b>MODEL 1873 SHORT RIFLE COLOR CASE HARDENED</b>										
534202137	357 Mag/38 Spl	10/11	20"	39"	13"	13/4"	3"	7 1/4	18 3/4"	\$1,579.99
534202140	44-40 Win	10	20"	39"	13"	13/4"	3"	7 1/4	36"	1,579.99
534202141	45 Colt	10	20"	39"	13"	13/4"	3"	7 1/4	26"	1,579.99
<b>MODEL 1873 SHORT RIFLE</b>										
534200137	357 Mag/38 Spl	10/11	20"	39"	13"	13/4"	3"	7 1/4	18 3/4"	\$1,299.99
534200140	44-40 Win	10	20"	39"	13"	13/4"	3"	7 1/4	36"	1,299.99
534200141	45 Colt	10	20"	39"	13"	13/4"	3"	7 1/4	26"	1,299.99

# MODEL 1873

# GENTLEMEN'S RIFLES.

THE GUNS THAT WON THE WEST ARE STILL READY TO RIDE.



FULL OCTAGON BARREL

DRILLED AND TAPPED TOP TANG

COLOR CASE HARDENING

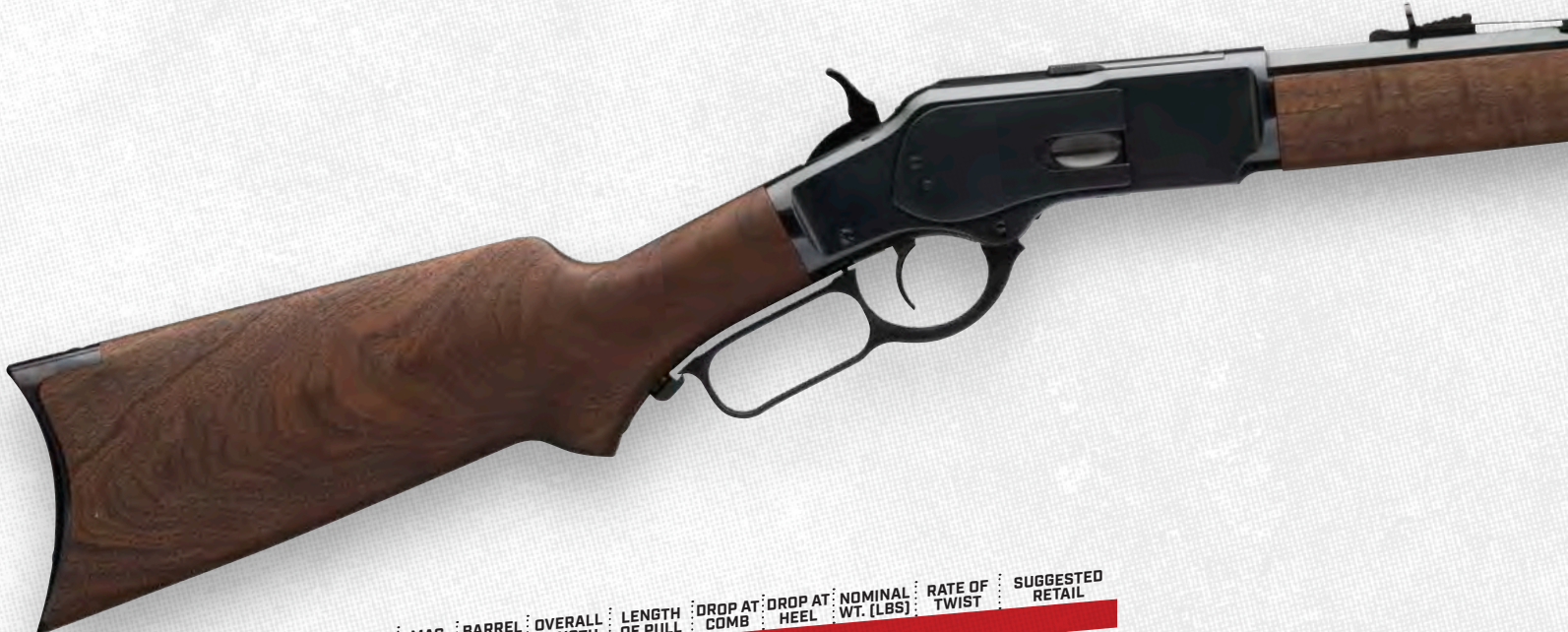

ITEM NUMBER	CALIBER	MAG CAP	BARREL LENGTH	OVERALL LENGTH	LENGTH OF PULL	DROP AT COMB	DROP AT HEEL	NOMINAL WT. (LBS)	RATE OF TWIST	SUGGESTED RETAIL
<b>MODEL 1873 SPORTER OCTAGON COLOR CASE HARDENED</b>										
534217137	357 Mag/38 Spl	13/14	24"	43"	13"	1 3/4"	3"	7 1/2	18 3/4"	\$1,739.99
534217140	44-40 Win	13	24"	43"	13"	1 3/4"	3"	7 1/2	36"	1,739.99
534217141	45 Colt	13	24"	43"	13"	1 3/4"	3"	7 1/4	26"	1,739.99





# SPORTER OCTAGON COLOR CASE HARDENED

- **GRADE II/III WALNUT STRAIGHT GRIP STOCK** with a satin oil finish that's velvet smooth to the touch
- **CLASSIC RIFLE-STYLE FOREARM** with forearm cap for the timeless look and feel of the original Model 1873
- **ELEGANT COLOR CASE HARDENING** on the robust steel receiver, lever, crescent buttplate and forearm cap protects against corrosion
- **CRESCENT BUTTPLATE** slips right into your shoulder for a more solid hold from any shooting position

- **SEMI-BUCKHORN REAR SIGHT AND MARBLE ARMS® GOLD BEAD FRONT SIGHT** get you on target quickly
- **STEEL LOADING GATE** for smoother loading
- **RECEIVER TOP TANG** is drilled and tapped for an optional tang-mounted rear sight that gives you a more precise sight picture and the timeless look and feel of shooting a long-barreled frontier rifle



# SPORTER OCTAGON PISTOL GRIP COLOR CASE HARDENED

- **GRADE II/III WALNUT PISTOL GRIP STOCK** with a satin oil finish that's velvet smooth to the touch
- **CLASSIC RIFLE-STYLE FOREARM** for the timeless look and feel of the original Model 1873
- **DEEPLY POLISHED BLUE OR COLOR CASE HARDENING** on the robust steel receiver, lever, crescent buttplate and forearm cap protect against corrosion
- **CRESCENT BUTTPLATE** slips right into your shoulder for a more solid hold from any shooting position

- **SEMI-BUCKHORN REAR SIGHT AND MARBLE ARMS® GOLD BEAD FRONT SIGHT** get you on target quickly
- **STEEL LOADING GATE** for smoother loading
- **RECEIVER TOP TANG** is drilled and tapped for an optional tang-mounted rear sight that gives you a more precise sight picture and the timeless look and feel of shooting a long-barreled frontier rifle



# SPORTER OCTAGON PISTOL GRIP

ITEM NUMBER	CALIBER	MAG CAP	BARREL LENGTH	OVERALL LENGTH	LENGTH OF PULL	DROP AT COMB	DROP AT HEEL	NOMINAL WT. (LBS)	RATE OF TWIST	SUGGESTED RETAIL
<b>MODEL 1873 SPORTER OCTAGON PISTOL GRIP COLOR CASE HARDENED</b>										
534228137	357 Mag/38 Spl	13/14	24"	43"	13"	1 3/4"	3"	8	18 3/4"	\$1,739.99
534228140	44-40 Win	13	24"	43"	13"	1 3/4"	3"	8	36"	1,739.99
534228141	45 Colt	13	24"	43"	13"	1 3/4"	3"	8	26"	1,739.99
<b>MODEL 1873 SPORTER OCTAGON PISTOL GRIP</b>										
534229137	357 Mag/38 Spl	13/14	24"	43"	13"	1 3/4"	3"	8	18 3/4"	\$1,469.99
534229140	44-40 Win	13	24"	43"	13"	1 3/4"	3"	8	36"	1,469.99
534229141	45 Colt	13	24"	43"	13"	1 3/4"	3"	8	26"	1,469.99

# Model 1873

MODEL 1885

# AWESOME.

THESE BEAUTIES RUN THE GAMUT FROM RIMFIRES TO THE 45-90 WINCHESTER® CENTERFIRE.



*Model 1886*

## SHORT RIFLE

- **SATIN FINISH WALNUT STOCK** for classic beauty
- **STRAIGHT GRIP** for genuine good looks and fast handling
- **STEEL CRESCENT BUTTPLATE** adds traditional look while protecting the buttstock
- **MARBLE ARMS® FRONT SIGHT AND BRASS BEAD** for easier sighting
- **ADJUSTABLE REAR SIGHT** gets you on target with any ammo
- **STEEL LOADING GATE** for smoother loading
- **BARREL** is button-rifled with a recessed crown for ultimate accuracy
- **RECEIVER** is drilled and tapped for an optional receiver mounted peep sight for a more precise sight picture

# Model 1885



NOTE: REAR SIGHT HAS BEEN REMOVED TO ALLOW THE SCOPE TO BE MOUNTED.

## HUNTER RIMFIRE

- **CHECKERED WALNUT PISTOL GRIP STOCK** with an oil finish that's velvet smooth to the touch
- **TIMELESS SCHNABEL STYLE FOREARM** with cut checkering sets the Hunter Rimfire apart from other rifles
- **PACHMAYR® RUBBER BUTTPAD** for non-slip shooting comfort
- **OCTAGON 24" BARREL** is button rifled for outstanding accuracy

- **SEMI-BUCKHORN REAR SIGHT AND MARBLE ARMS® GOLD BEAD FRONT SIGHT** get you on target quickly
- **CURVED BLUED STEEL FINGER LEVER** is comfortable in the hand and smoothly activates the steel falling breechblock for loading and ejection
- **BLUED STEEL RECEIVER AND BARREL** are drilled and tapped for scope mounting

# Model 1886



## DELUXE RIFLE

- **HIGH GRADE III/IV SATIN FINISH WALNUT STOCK** for deep grain beauty, with classic cut checkering for a sure grip
- **PISTOL GRIP** for good looks, improved grip and fast handling
- **STEEL CRESCENT BUTTPLATE** adds a traditional look while protecting the buttstock
- **COLOR CASE HARDENING** on the robust steel receiver, lever, crescent buttplate, grip cap, lower tang and forearm cap protect against corrosion

- **MARBLE ARMS® FRONT SIGHT AND BRASS BEAD** for easier sighting
- **ADJUSTABLE REAR SIGHT** gets you on target with any ammo
- **STEEL LOADING GATE** for smoother loading
- **BARREL** is button-rifled for ultimate accuracy
- **RECEIVER** is drilled and tapped for an optional receiver mounted peep sight for a more precise sight picture

(SCOPE AND MOUNTS SHOWN NOT INCLUDED)

ITEM NUMBER	CALIBER	MAG CAP	BARREL LENGTH	OVERALL LENGTH	LENGTH OF PULL	DROP AT COMB	DROP AT HEEL	NOMINAL WT. (LBS)	RATE OF TWIST	SUGGESTED RETAIL
<b>MODEL 1885 LOW WALL HUNTER RIMFIRE</b>										
524100170	17 HMR	N/A	24"	40"	13 1/2"	3/4"	11/4"	7 1/2	9"	\$1,469.99
524100186	17 WSM	N/A	24"	40"	13 1/2"	3/4"	11/4"	7 1/2	9"	1,469.99
524100102	22 LR	N/A	24"	40"	13 1/2"	3/4"	11/4"	7 1/2	16"	1,469.99
524100104	22 WMR	N/A	24"	40"	13 1/2"	3/4"	11/4"	7 1/2	16"	1,469.99
<b>MODEL 1886 DELUXE RIFLE</b>										
534227142	45-70 Govt	8	24"	43"	13 1/4"	11/4"	2"	8 3/8	20"	\$1,739.99
<b>MODEL 1886 SHORT RIFLE</b>										
534175142	45-70 Govt	8	24"	43"	13 1/4"	11/4"	2"	8 3/8	20"	\$1,339.99
<b>NEW</b> 534175171	45-90 WCF	8	24"	43"	13 1/4"	11/4"	2"	8 3/8	20"	1,339.99

# Model 1886

MODEL 1892™

# LEVERAGE.

THE FINEST LEVER-ACTION SADDLE GUNS EVER TO CARRY  
THE WINCHESTER® NAME.



**NEW**

## LARGE LOOP CARBINE

- **WALNUT STRAIGHT GRIP STOCK** with a satin finish that's velvet smooth to the touch
- **LARGE LOOP LEVER** harkens back to the carbines that were staples of Hollywood's legendary western movies of the 1940s and 1950s.
- **CLASSIC CARBINE-STYLE FOREARM** with blued steel barrel band for the timeless look and feel of the original Model 1892™ carbine

- **BLUED STEEL CARBINE STRAP BUTTPLATE** slips into your shoulder for a solid hold
- **LADDER REAR SIGHT AND MARBLE ARMS® GOLD BEAD FRONT SIGHT** get you on target quickly
- **STEEL LOADING GATE** for smoother loading
- **TOP TANG** is drilled and tapped for an optional receiver mounted peep sight for a more precise sight picture



# SHORT RIFLE

- **WALNUT STRAIGHT GRIP STOCK** with a satin finish that's velvet smooth to the touch
- **CLASSIC RIFLE-STYLE FOREARM** with blued steel cap for the timeless look and feel of the original Model 1892™ rifle
- **BLUED STEEL CRESCENT BUTTPLATE** slips into your shoulder for a solid hold

- **SEMI-BUCKHORN REAR SIGHT AND MARBLE ARMS® GOLD BEAD FRONT SIGHT** get you on target quickly
- **STEEL LOADING GATE** for smoother loading
- **TOP TANG** is drilled and tapped for an optional receiver mounted peep sight for a more precise sight picture



# CARBINE

- **WALNUT STRAIGHT GRIP STOCK** with a satin finish that's velvet smooth to the touch
- **CLASSIC CARBINE-STYLE FOREARM** with blued steel barrel band for the timeless look and feel of the original Model 1892™ carbine
- **BLUED STEEL CARBINE STRAP BUTTPLATE** slips into your shoulder for a solid hold

- **SEMI-BUCKHORN REAR SIGHT AND MARBLE ARMS® GOLD BEAD FRONT SIGHT** get you on target quickly
- **STEEL LOADING GATE** for smoother loading
- **TOP TANG** is drilled and tapped for an optional receiver mounted peep sight for a more precise sight picture

	ITEM NUMBER	CALIBER	MAG CAP	BARREL LENGTH	OVERALL LENGTH	LENGTH OF PULL	DROP AT COMB	DROP AT HEEL	NOMINAL WT. (LBS)	RATE OF TWIST	SUGGESTED RETAIL
<b>MODEL 1892 SHORT RIFLE</b>											
	534162137	357 Mag	10	20"	37 1/2"	12 3/4"	11/8"	1 3/4"	6	18 3/4"	\$1,069.99
	534162124	44 Rem Mag	10	20"	37 1/2"	12 3/4"	11/8"	1 3/4"	6	26"	1,069.99
<b>NEW</b>	534162140	44-40 Win	10	20"	37 1/2"	12 3/4"	11/8"	1 3/4"	6	36"	1,069.99
	534162141	45 Colt	10	20"	37 1/2"	12 3/4"	11/8"	1 3/4"	6	26"	1,069.99
<b>MODEL 1892 CARBINE</b>											
	534177137	357 Mag	10	20"	37 1/2"	12 3/4"	11/8"	1 3/4"	6	18 3/4"	\$1,069.99
	534177124	44 Rem Mag	10	20"	37 1/2"	12 3/4"	11/8"	1 3/4"	6	26"	1,069.99
	534177140	44-40 Win	10	20"	37 1/2"	12 3/4"	11/8"	1 3/4"	6	36"	1,069.99
	534177141	45 Colt	10	20"	37 1/2"	12 3/4"	11/8"	1 3/4"	6	26"	1,069.99
<b>MODEL 1892 LARGE LOOP CARBINE</b>											
<b>NEW</b>	534190137	357 Mag	10	20"	37 1/2"	12 3/4"	11/8"	1 3/4"	6	18 3/4"	\$1,259.99
<b>NEW</b>	534190124	44 Rem Mag	10	20"	37 1/2"	12 3/4"	11/8"	1 3/4"	6	26"	1,259.99
<b>NEW</b>	534190140	44-40 Win	10	20"	37 1/2"	12 3/4"	11/8"	1 3/4"	6	36"	1,259.99
<b>NEW</b>	534190141	45 Colt	10	20"	37 1/2"	12 3/4"	11/8"	1 3/4"	6	26"	1,259.99

# CELEBRATE GREATNESS.

THE MOST POPULAR DEER RIFLE IN HISTORY IS RICHLY CELEBRATED IN THESE TWO MAGNIFICENT LIMITED EDITION COLLECTOR GUNS.



**DEEP RELIEF, HAND-CHASED ENGRAVING WITH GOLD EMBELLISHMENTS BY GIOVANELLI OF ITALY** of the Horse and Rider and the Winchester® banner on the left side of the receiver on the 125th Anniversary Custom Model 94®.



**DEEP RELIEF, HAND-CHASED ENGRAVING WITH GOLD EMBELLISHMENTS BY GIOVANELLI OF ITALY** of a classic running deer scene on the right side of the receiver on the 125th Anniversary Custom Model 94®.



**FULL OCTAGON BARREL** with a highly polished, deeply blued finish and special 125th Anniversary gold markings create a wonderful historic flavor.



**CRISP BORDERED CUT CHECKERING** with spade pattern insets decorate the grip and forearm.



**DEEP RELIEF, HAND-CHASED ENGRAVING BY GIOVANELLI OF ITALY** of the Horse and Rider and the Winchester® banner on the left side of the receiver on the 125th Anniversary High Grade Model 94®.



**DEEP RELIEF, HAND-CHASED ENGRAVING BY GIOVANELLI OF ITALY** of a trophy whitetail buck and the Winchester® banner on the right side of the receiver on the 125th Anniversary High Grade Model 94®.

← **MODEL 94** →  
**125 Years**  
 1894 2019

2019 marks the 125th anniversary of the legendary Model 94® lever-action rifle from Winchester Repeating Arms®. Over that time more than 7 million of these slim, handy guns have been produced. It's still America's all-time favorite deep woods and rough country whitetail deer rifle.



**NEW 125<sup>TH</sup> CUSTOM**

- **GRADE V/VI WALNUT STOCK** with oil finish, authentic straight-grip styling and a blued steel forearm band offer a nostalgic look
- **FULL BORDERED CUT CHECKERING** with spade insets on both the grip and forearm
- **STUNNING HAND CHASED DEEP RELIEF ENGRAVING** with gold embellished accents on both sides of the receiver
- **HIGHLY POLISHED DEEPLY BLUED METALWORK** further complements the magnificent engraving
- **SPECIAL BARREL MARKINGS** commemorate the unique nature of this collectable rifle
- **TRIPLE-CHECKED, BUTTON RIFLED, FULL OCTAGON BARREL** for the ultimate in accuracy and precision

- **STEEL CRESCENT BUTTPLATE** adds a traditional look while protecting the buttstock
- **HAMMER** is drilled and tapped for a **KNURLED HAMMER SPUR EXTENSION** (included) to aid in cocking and decocking the hammer when a scope is mounted
- **GOLD BEAD FRONT SIGHT AND ADJUSTABLE SEMI-BUCKHORN REAR SIGHT** get you on target quickly
- **STEEL LOADING GATE** for smoother loading
- **ARTICULATED CARTRIDGE STOP** improves feeding reliability without damaging cartridges
- **TOP TANG IS DRILLED AND TAPPED** for an optional tang sight



**NEW 125<sup>TH</sup> HIGH GRADE**

- **GRADE III/IV WALNUT STOCK** with oil finish, authentic straight-grip styling and a blued steel forearm band offer a nostalgic look
- **FULL BORDERED CUT CHECKERING** with spade insets on both the grip and forearm
- **STUNNING DEEP RELIEF ENGRAVING** on both sides of the receiver complements the magnificent engraving
- **HIGHLY POLISHED DEEPLY BLUED METALWORK** further complements the magnificent engraving
- **SPECIAL BARREL MARKINGS** commemorate the unique nature of this collectable rifle
- **TRIPLE-CHECKED, BUTTON RIFLED, FULL OCTAGON BARREL** for the ultimate in accuracy and precision

- **STEEL CRESCENT BUTTPLATE** adds a traditional look while protecting the buttstock
- **HAMMER** is drilled and tapped for a **KNURLED HAMMER SPUR EXTENSION** (included) to aid in cocking and decocking the hammer when a scope is mounted
- **GOLD BEAD FRONT SIGHT AND ADJUSTABLE SEMI-BUCKHORN REAR SIGHT** get you on target quickly
- **STEEL LOADING GATE** for smoother loading
- **ARTICULATED CARTRIDGE STOP** improves feeding reliability without damaging cartridges
- **TOP TANG IS DRILLED AND TAPPED** for an optional tang sight

	ITEM NUMBER	CALIBER	MAG CAP	BARREL LENGTH	OVERALL LENGTH	LENGTH OF PULL	DROP AT COMB	DROP AT HEEL	NOMINAL WT. (LBS)	RATE OF TWIST	SUGGESTED RETAIL
	<b>MODEL 94 125<sup>TH</sup> ANNIVERSARY CUSTOM</b>										
<b>NEW</b>	534267114	30-30 Win	8	24"	43 1/2"	13 1/2"	11/4"	13/4"	7 1/2	12"	\$1,199.99
	<b>MODEL 94 125<sup>TH</sup> ANNIVERSARY HIGH GRADE</b>										
<b>NEW</b>	534268114	30-30 Win	8	24"	43 1/2"	13 1/2"	11/4"	13/4"	7 1/2	12"	\$1,459.99

**MODEL 94**

MODEL 94®

# LEGENDARY LEVERS.

TWO LEVER-ACTIONS THAT EMBODY THE SPIRIT OF THE WINCHESTER® MODEL 94®; THE MOST POPULAR DEER RIFLE IN HISTORY.



← MODEL 94 →  
*125 Years*  
1894 2019

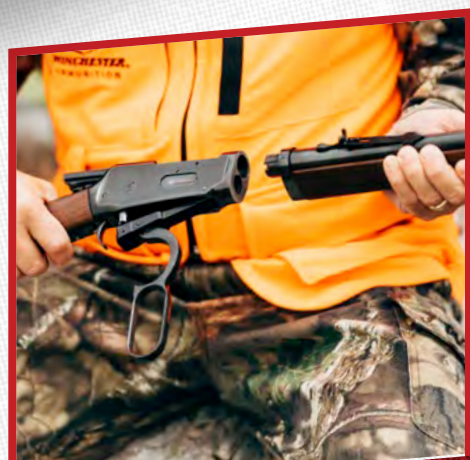

If you want a truly compact rifle that you can carry in your backpack, wrap in your bedroll, strap to your ATV or tuck behind the seat of your truck, boat or bush plane, the **MODEL 94® TAKEDOWN** is what you need. It comes apart with just a quick twist into two compact components — the barrel assembly and the stocked receiver assembly. **REASSEMBLY** is easy. Put the two pieces together, give the end of the magazine tube a few turns and you instantly have a full-length rifle with the same superb accuracy as the other Model 94 models.



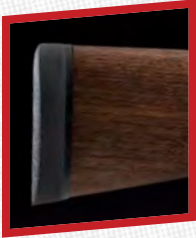

**PACHMAYR® DECELERATOR® RECOIL PAD** is a welcome addition to models chambered in 450 Marlin.



**BARREL PORTS** ease felt recoil and reduce muzzle jump on models chambered in 450 Marlin.



# CARBINE

- **WALNUT STOCK** with satin finish, authentic straight-grip styling and a blued steel forearm band offer a nostalgic look
- **BLUED STEEL CARBINE STRAP BUTTPLATE** for smooth and easy shouldering
- **TRIPLE-CHECKED BUTTON RIFLED BARREL** for the ultimate in accuracy and precision
- **ROUND LOCKING BOLT TRUNNIONS** help ensure a smooth, quick lever throw
- **BOLT RELIEF CUT** reduces hammer drag for smoother cocking
- **RADIUSED LEVER EDGES** give added protection to your fingers

- **HAMMER** is drilled and tapped for a **KNURLED HAMMER SPUR EXTENSION** (included) to aid in cocking and decocking the hammer when a scope is mounted
- **MARBLE ARMS® FRONT SIGHT AND ADJUSTABLE SEMI-BUCKHORN REAR SIGHT** get you on target quickly
- **STEEL LOADING GATE** for smoother loading
- **ARTICULATED CARTRIDGE STOP** improves feeding reliability without damaging cartridges
- **DRILLED AND TAPPED FOR SCOPE MOUNTS** to easily attach your favorite optics



# TRAILS END TAKEDOWN

- **WALNUT STOCK** with satin finish, authentic straight-grip styling and a blued steel forearm cap offer a nostalgic look
- **TRADITIONAL TAKEDOWN MECHANISM** is fast and easy to operate
- **TRIPLE-CHECKED BUTTON RIFLED BARREL** for the ultimate in accuracy and precision
- **ROUND LOCKING BOLT TRUNNIONS** help ensure a smooth, quick lever throw
- **BOLT RELIEF CUT** reduces hammer drag for smoother cocking
- **RADIUSED LEVER EDGES** give added protection to your fingers

- **HAMMER** is drilled and tapped for a **KNURLED HAMMER SPUR EXTENSION** (included) to aid in cocking and decocking the hammer when a scope is mounted
- **MARBLE ARMS® FRONT SIGHT AND ADJUSTABLE SEMI-BUCKHORN REAR SIGHT** get you on target quickly
- **STEEL LOADING GATE** for smoother loading
- **ARTICULATED CARTRIDGE STOP** improves feeding reliability without damaging cartridges
- **DRILLED AND TAPPED FOR SCOPE MOUNTS** to easily attach your favorite optics

ITEM NUMBER	CALIBER	MAG CAP	BARREL LENGTH	OVERALL LENGTH	LENGTH OF PULL	DROP AT COMB	DROP AT HEEL	NOMINAL WT. (LBS)	RATE OF TWIST	SUGGESTED RETAIL
<b>MODEL 94 CARBINE</b>										
534199114	30-30 Win	7	20"	38"	13 1/2"	11/4"	13/4"	6 1/2	12"	\$1,199.99
534199117	38-55 Win	7	20"	38"	13 1/2"	11/4"	13/4"	6 1/2	15"	1,199.99
<b>MODEL 94 TRAILS END TAKEDOWN</b>										
534191114	30-30 Win	6	20"	38"	13 1/2"	11/4"	13/4"	6 3/4	12"	\$1,459.99
534191117	38-55 Win	6	20"	38"	13 1/2"	11/4"	13/4"	6 3/4	15"	1,459.99
534191160	450 Marlin	6	20"	38"	13 1/2"	11/4"	13/4"	6 3/4	20"	1,459.99

# MODEL 94®

MODEL 94®

# CLASS ACTS.

TREASURE YOUR TIME HUNTING IN THE DEEP WOODS OR SHOOTING ON THE RANGE WITH THIS PAIR OF CLASSIC WINCHESTER® MODEL 94® RIFLES.



PACHMAYR® DECELERATOR® RECOIL PAD is a welcome addition to models chambered in 450 Marlin.



MODEL 94  
 125 Years  
 1894 2019



**BARREL PORTS** ease felt recoil and reduce muzzle jump on models chambered in 450 Marlin.



# SHORT RIFLE

- **WALNUT STOCK** with satin finish, authentic straight-grip styling and a blued steel forearm cap offer a nostalgic look
- **SHOTGUN STYLE BUTTPLATE** for smooth and easy shouldering
- **TRIPLE-CHECKED BUTTON RIFLED BARREL** for the ultimate in accuracy and precision
- **ROUND LOCKING BOLT TRUNNIONS** help ensure a smooth, quick lever throw
- **BOLT RELIEF CUT** reduces hammer drag for smoother cocking
- **RADIUSED LEVER EDGES** give added protection to your fingers

- **HAMMER** is drilled and tapped for a **KNURLED HAMMER SPUR EXTENSION** (included) to aid in cocking and decocking the hammer when a scope is mounted
- **MARBLE ARMS® FRONT SIGHT AND ADJUSTABLE SEMI-BUCKHORN REAR SIGHT** get you on target quickly
- **STEEL LOADING GATE** for smoother loading
- **ARTICULATED CARTRIDGE STOP** improves feeding reliability without damaging cartridges
- **DRILLED AND TAPPED FOR SCOPE MOUNTS** to easily attach your favorite optics

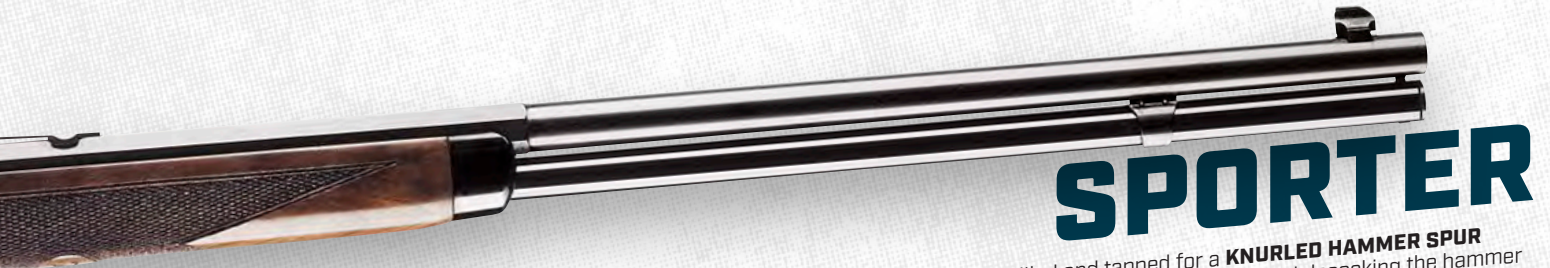

# SPORTER

- **WALNUT STOCK** with satin finish, authentic straight-grip styling, bordered cut checkering and a blued steel forearm cap offer a nostalgic look
- **BLUED CRESCENT BUTTPLATE** slips firmly into your shoulder for a solid hold
- **TRIPLE-CHECKED HALF ROUND/HALF OCTAGON BUTTON RIFLED BARREL** for the ultimate in accuracy and precision
- **ROUND LOCKING BOLT TRUNNIONS** help ensure a smooth, quick lever throw
- **BOLT RELIEF CUT** reduces hammer drag for smoother cocking
- **RADIUSED LEVER EDGES** give added protection to your fingers

- **HAMMER** is drilled and tapped for a **KNURLED HAMMER SPUR EXTENSION** (included) to aid in cocking and decocking the hammer when a scope is mounted
- **MARBLE ARMS® FRONT SIGHT AND ADJUSTABLE SEMI-BUCKHORN REAR SIGHT** get you on target quickly
- **STEEL LOADING GATE** for smoother loading
- **ARTICULATED CARTRIDGE STOP** improves feeding reliability without damaging cartridges
- **DRILLED AND TAPPED FOR SCOPE MOUNTS** to easily attach your favorite optics

ITEM NUMBER	CALIBER	MAG CAP	BARREL LENGTH	OVERALL LENGTH	LENGTH OF PULL	DROP AT COMB	DROP AT HEEL	NOMINAL WT. (LBS)	RATE OF TWIST	SUGGESTED RETAIL
<b>MODEL 94 SHORT RIFLE</b>										
534174114	30-30 Win	7	20"	38"	13 1/2"	11/4"	13/4"	6 3/4	12"	\$1,229.99
534174117	38-55 Win	7	20"	38"	13 1/2"	11/4"	13/4"	6 3/4	15"	1,229.99
534174160	450 Marlin	7	20"	38"	13 1/2"	11/4"	13/4"	6 3/4	20"	1,229.99
<b>MODEL 94 SPORTER</b>										
534178114	30-30 Win	8	24"	42 1/2"	13 1/2"	11/4"	13/4"	7 1/2	12"	\$1,399.99
534178117	38-55 Win	8	24"	42 1/2"	13 1/2"	11/4"	13/4"	7 1/2	15"	1,399.99

# MODEL 94®

# SUPER X<sup>®</sup>4

**THE SOFT SHOOTING AUTOLOADER THAT'S BUILT 4 SPEED.**

The Winchester<sup>®</sup> Super X<sup>®</sup>4 autoloading shotgun has quickly developed a worldwide reputation for blazing speed, reliability and smooth handling. That's why the NRA recently crowned it with their coveted Golden Bullseye Award as Shotgun of the Year for 2018. For 2019 we introduce a new model specifically for the upland game hunter and a pair of compact models that are sized right to fit the smaller shooter. Plus the Super X<sup>®</sup>4 is now available in the popular 20 gauge chambering. Discover why the Winchester Super X4 is the world-class autoloading shotgun that is **BUILT 4 SPEED.**



**"...THE SX4 AND I DANCED FROM DAWN TILL DUSK, AND FROM START TO FINISH IT WAS RAISE, SHOULDER, SWING AND PULL, CLEARING THE CANADIAN SKY LIKE WE'VE BEEN DOING IT TOGETHER OUR ENTIRE LIVES. SOMETIMES A GUN JUST FEELS RIGHT, AND THE SX4...IS ONE OF THOSE GUNS."**

— Jon Draper • Editor, *NRA American Hunter*



One of the first things experienced shooters notice about the Super X<sup>®</sup>4 is the gun's **IMPROVED ERGONOMICS.** It's **LIGHTER OVERALL** and **THE PISTOL GRIP IS ROUNDED AND MORE COMFORTABLE,** regardless of which hand you use to pull the trigger. The gun's overall balance point has been moved slightly forward to **CREATE A MORE FLUID SWING, BETTER TARGET TRACKING AND SMOOTHER FOLLOW-THROUGH.**



The fit and balance of a shotgun stock are critical factors of how well you're able to shoot it. The Super X<sup>®</sup>4 comes with polymer **LENGTH OF PULL SPACERS** that fit between the stock and the recoil pad. When adjusted properly, you shoulder the shotgun with a smooth confidence and felt recoil is greatly diminished. Synthetic stock Super X4 models come with one spacer already installed to provide a standard 14 1/4" length of pull, and include one additional spacer in the box. Wood stock models include two length of pull spacers in the box. When you remove or add a spacer, you change the length of pull by 1/4".

The latest evolution of the **INFLEX TECHNOLOGY RECOIL PAD ON THE SUPER X<sup>®</sup>4 FURTHER REDUCES FELT RECOIL.** Specially shaped rib structures located inside the pad help direct and channel the recoil impulse, moving the comb down and away from your cheek to reduce felt recoil to very manageable levels, even when shooting heavy magnum loads. The new pad's **LARGER FOOTPRINT SPREADS RECOIL FORCES OVER A WIDER AREA** for further cushioning.

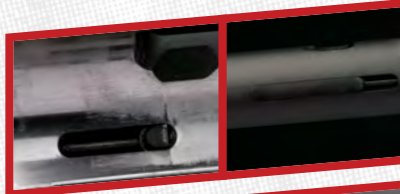

The Super X<sup>®</sup>4 features a **SPRING-LOADED EJECTOR** that throws the empty shell out of the ejection port as soon as it clears the chamber for faster, more reliable operation, regardless of shell length.



The Super X<sup>®</sup>4 features a **LARGER BOLT HANDLE** and an **OVERSIZED BOLT RELEASE BUTTON** for easy engagement and fast operation; two very important features when your hands are cold and wet or when you're wearing gloves. The carrier and bolt release button are coated with nickel Teflon<sup>®</sup> to reduce friction and help prevent corrosion.



The larger, easier to operate **AMBIDEXTROUS SAFETY** button on the Super X<sup>®</sup>4 is located at the rear of the angular-profile trigger guard and is easily reversible for both right- or left-handed shooters. The opening on **THE TRIGGER GUARD IS GENEROUSLY SIZED FOR EASIER ACCESS,** even when wearing heavy gloves.

**NEW COMPACT MODELS OF THE SUPER X<sup>®</sup>4 OFFER 13" LENGTH OF PULL** to better fit smaller statured shooters. Two 1/4" spacers are included to create a more custom fit.

**BACK-BORED TECHNOLOGY**

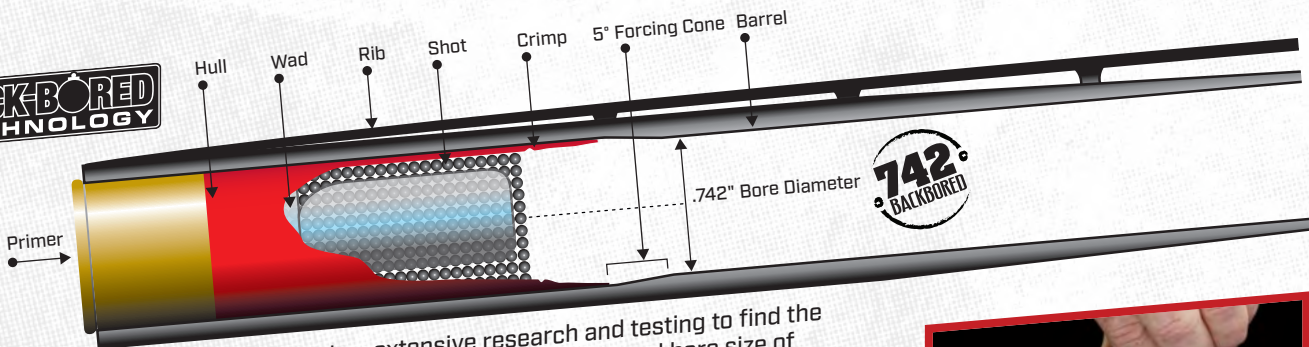

**BACK-BORED TECHNOLOGY** is based on extensive research and testing to find the secret to tighter, more consistent patterns. Instead of the traditional bore size of .729", this research shows the ideal 12 gauge interior diameter is .742". If the bore is any larger, the gases will blow by the shot cup and reduce pellet velocity. If the bore is too tight, the pellets are deformed as they pass through the forcing cone, causing poor ballistic performance.

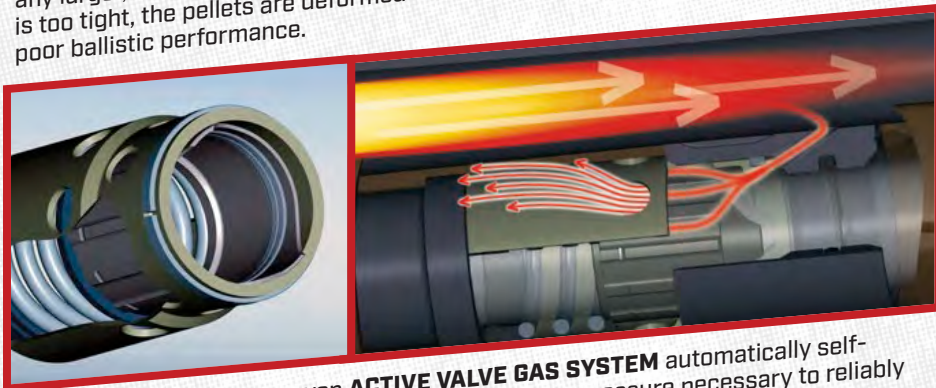

**ACTIVE VALVE system**

The proven **ACTIVE VALVE GAS SYSTEM** automatically self-adjusts to allocate the exact gas pressure necessary to reliably cycle a wide range of loads commonly used for hunting or target shooting. When firing the heaviest magnum loads in

3 1/2" models, gases vent upward and a portion of them are vented forward out the Quadra-Vent ports in the forearm to help regulate bolt speed. Both 3" and 3 1/2" Super X<sup>®</sup>4 shotguns will reliably cycle even 1 1/8 oz., 2 3/4" light loads. Excess gases from heavy loads are channeled through the forward **QUADRA-VENT™** ports for cleaner and more reliable operation.



**LOAD DIVERSITY** means a Super X<sup>®</sup>4 can reliably shoot them all, from light factory field shells to heavy magnum waterfowl and turkey loads. The proven Active Valve on the Super X4 makes it the most versatile autoloader on the range, in the marsh and in the field.



**"AFTER SPENDING CONSIDERABLE TIME WITH THE NEW SUPER X<sup>®</sup>4, ITS FEEL AND POINTABILITY ARE SECOND TO NONE."**  
— John Stephens • RNT-V



The Super X<sup>®</sup>4 has a **DROP-OUT TRIGGER GROUP** that's easy to remove for detailed cleaning and lubrication. The **SELF-ALIGNING BOLT CARRIER LINK** makes it easy to reassemble.



**CHROME-PLATED CHAMBER AND BORE** are critical for today's steel and Hi-Density (HD) shot. Hard chrome makes the surfaces highly resistant to wear and gives you superior protection from rust and corrosion. That's why all smoothbore Super X<sup>®</sup>4 shotguns feature a hard-chromed chamber and bore.



From the duck blind to the firing line, the **INVECTOR-PLUS™ CHOKE TUBE SYSTEM** is the world's most consistent. Because the threads are located at the bottom of the choke tube they seal out corrosive gases better. The tube's thicker walls make Invector-Plus chokes much stronger than any other choke tube system, yet they remain easy to remove and clean. They are more concentric with the bore and thus produce more even, consistent shot patterns. The Super X<sup>®</sup>4 comes with full, modified and improved cylinder flush-mounted choke tubes so your gun is ready for anything, right out of the box.

**SX4™**

# SUPER X<sup>4</sup>

# GET IT DONE.

HERE'S A PAIR OF SMOOTH SWINGING AUTOLOADERS THAT ARE READY FOR JUST ABOUT ANYTHING.



NOW IN  
**20  
GAUGE**



**STACKED. FAST. DEADLY™**  
Blind Side combines ground-breaking, stacked Hex Steel Shot technology and the new diamond cut wad in the most deadly Winchester® waterfowl load available. Loaded with 100% Hex shot, you get more pellets on target, a larger kill zone and more trauma inducing pellets than ever before, meaning more fast kills.



**"NO MATTER THE CONDITIONS, THE SUPER X<sup>4</sup>, WHEN CALLED UPON, WILL DO ITS JOB EVERY TIME YOU PULL THE TRIGGER."**  
— Jim Ronquest • RNT-V



NOW IN  
**20  
GAUGE**





# SUPER X<sup>®</sup> 4



- **SYNTHETIC STOCK WITH IMPROVED ERGONOMICS, A ROUNDED PISTOL GRIP AND TEXTURED GRIPPING SURFACES** gives your hands a sure, non-slip grip. The non-glare matte black finish won't spook wary game
- **BACK-BORED TECHNOLOGY** provides optimum shot patterns that are dense and even
- **INVECTOR-PLUS™ CHOKE TUBE SYSTEM** offers consistent patterns to match your target situation
- **HARD CHROME-PLATED CHAMBER AND BORE** make these surfaces highly resistant to wear and corrosion
- **TRUGLO® LONG BEAD™ FIBER-OPTIC FRONT SIGHT** offers a true, precise sight picture
- **VENT RIB** gives you a smooth, clean sighting plane

- **SELF-ADJUSTING ACTIVE VALVE GAS SYSTEM** cycles a wide variety of loads while reducing felt recoil
- **QUADRA-VENT™ PORTS** vent excess gases for cleaner operation
- **DROP-OUT TRIGGER GROUP** allows for easy cleaning
- **AMBIDEXTROUS CROSSBOLT SAFETY** is easily reversible
- **LARGER BOLT HANDLE AND BOLT RELEASE BUTTON** are fast and easy to operate
- **LENGTH OF PULL SPACERS** allow stock adjustments to achieve a perfect fit
- **INFLEX TECHNOLOGY RECOIL PAD** directs felt recoil down and away from your cheek to reduce flinch and fatigue



# WATERFOWL HUNTER



- **SYNTHETIC STOCK WITH IMPROVED ERGONOMICS, A ROUNDED PISTOL GRIP AND TEXTURED GRIPPING SURFACES** gives your hands a sure, non-slip grip. Full coverage Mossy Oak® Shadow Grass Blades camo finish means your gun won't give you away to close range waterfowl
- **BACK-BORED TECHNOLOGY** provides optimum shot patterns that are dense and even
- **INVECTOR-PLUS™ CHOKE TUBE SYSTEM** offers consistent patterns to match your target situation
- **HARD CHROME-PLATED CHAMBER AND BORE** make these surfaces highly resistant to corrosion and wear from steel shot
- **VENT RIB** gives you a smooth, clean sighting plane
- **TRUGLO® LONG BEAD™ FIBER-OPTIC FRONT SIGHT** offers a true, precise sight picture

- **SELF-ADJUSTING ACTIVE VALVE GAS SYSTEM** cycles a wide variety of loads while reducing felt recoil
- **QUADRA-VENT™ PORTS** vent excess gases for cleaner operation
- **DROP-OUT TRIGGER GROUP** allows for easy cleaning
- **AMBIDEXTROUS CROSSBOLT SAFETY** is easily reversible
- **LARGER BOLT HANDLE AND BOLT RELEASE BUTTON** are fast and easy to operate
- **LENGTH OF PULL SPACERS** allow stock adjustments to achieve a perfect fit
- **INFLEX TECHNOLOGY RECOIL PAD** directs felt recoil down and away from your cheek to reduce flinch and fatigue

	ITEM NUMBER	GAUGE	BARREL LENGTH	CHAMBER	MAG CAP	CHOKE TUBES INCLUDED	OVERALL LENGTH	LENGTH OF PULL	DROP AT COMB	DROP AT HEEL	NOMINAL WT. (LBS)	SUGGESTED RETAIL
<b>SX4</b>	511205291	12	26"	3 1/2"	4*	F, M, IC	47"	14 1/4"	13/4"	2"	7	\$939.99
	511205292	12	28"	3 1/2"	4*	F, M, IC	49"	14 1/4"	13/4"	2"	7 1/8	939.99
	511205391	12	26"	3"	4*	F, M, IC	47"	14 1/4"	13/4"	2"	6 7/8	799.99
	511205392	12	28"	3"	4*	F, M, IC	49"	14 1/4"	13/4"	2"	7	799.99
	511205690	20	24"	3"	4*	F, M, IC	45"	14 1/4"	13/4"	2"	6 1/2	939.99
<b>NEW</b>	511205691	20	26"	3"	4*	F, M, IC	47"	14 1/4"	13/4"	2"	6 5/8	939.99
<b>NEW</b>	511205692	20	28"	3"	4*	F, M, IC	49"	14 1/4"	13/4"	2"	6 3/4	939.99
<b>SX4 WATERFOWL HUNTER (MOSSY OAK SHADOW GRASS BLADES)</b>												
	511206291	12	26"	3 1/2"	4*	F, M, IC	47"	14 1/4"	13/4"	2"	7	\$1,069.99
	511206292	12	28"	3 1/2"	4*	F, M, IC	49"	14 1/4"	13/4"	2"	7 1/8	1,069.99
	511206391	12	26"	3"	4*	F, M, IC	47"	14 1/4"	13/4"	2"	6 7/8	939.99
	511206392	12	28"	3"	4*	F, M, IC	49"	14 1/4"	13/4"	2"	7	939.99
<b>NEW</b>	511206691	20	26"	3"	4*	F, M, IC	47"	14 1/4"	13/4"	2"	6 5/8	1,069.99
<b>NEW</b>	511206692	20	28"	3"	4*	F, M, IC	49"	14 1/4"	13/4"	2"	6 3/4	1,069.99

\*TOTAL AMMUNITION CAPACITY INCLUDES ONE ADDITIONAL SHELL IN THE CHAMBER.

# SUPER X<sup>4</sup>

# SMALL WONDERS.

TWO NEW COMPACT SUPER X<sup>4</sup> AUTOLOADERS THAT ARE SIZED JUST RIGHT FOR SMALLER HUNTERS AND SHOOTERS.



### FLIES FAST, HITS HARD, KILLS DUCKS.

Flooded timber, swamps, marshes, duck blinds and john boats; duck hunters get wet ... it's all part of the hunt. Drylok Super Steel loads are trusted by the most hard-core duck hunters in the harshest of conditions. Winchester® patented technology is designed to keep your shotgun shells dry, time after time, no matter where you are. When it matters, you need Drylok Super Steel.



- **COMPACT 13" LENGTH OF PULL** to better fit smaller statured shooters
- **SYNTHETIC STOCK WITH IMPROVED ERGONOMICS, A ROUNDED PISTOL GRIP AND TEXTURED GRIPPING SURFACES** gives your hands a sure, non-slip grip. Full coverage Mossy Oak® Shadow Grass Blades camo finish means your gun won't give you away to close range waterfowl
- **BACK-BORED TECHNOLOGY** provides optimum shot patterns that are dense and even
- **INVECTOR-PLUS™ CHOKE TUBE SYSTEM** offers consistent patterns to match your target situation

- **HARD CHROME-PLATED CHAMBER AND BORE** make these surfaces highly resistant to corrosion and wear from steel shot
- **VENT RIB** gives you a smooth, clean sighting plane
- **TRUGLO® LONG BEAD™ FIBER-OPTIC FRONT SIGHT** offers a true, precise sight picture
- **SELF-ADJUSTING ACTIVE VALVE GAS SYSTEM** cycles a wide variety of loads while reducing felt recoil
- **QUADRA-VENT™ PORTS** vent excess gases for cleaner operation
- **DROP-OUT TRIGGER GROUP** allows for easy cleaning
- **AMBIDEXTROUS CROSSBOLT SAFETY** is easily reversible
- **LARGER BOLT HANDLE AND BOLT RELEASE BUTTON** are fast and easy to operate
- **PACHMAYR® DECELERATOR® RECOIL PAD** helps reduce flinch and fatigue





# NEW SUPER X<sup>4</sup> COMPACT



- **COMPACT 13" LENGTH OF PULL** to better fit smaller statured shooters
- **SYNTHETIC STOCK WITH IMPROVED ERGONOMICS, A ROUNDED PISTOL GRIP AND TEXTURED GRIPPING SURFACES** gives your hands a sure, non-slip grip. The non-glare matte black finish won't spook wary game
- **BACK-BORED TECHNOLOGY** provides optimum shot patterns that are dense and even
- **INVECTOR-PLUS™ CHOKE TUBE SYSTEM** offers consistent patterns to match your target situation
- **HARD CHROME-PLATED CHAMBER AND BORE** make these surfaces highly resistant to wear and corrosion

- **TRUGLO® LONG BEAD™ FIBER-OPTIC FRONT SIGHT** offers a true, precise sight picture
- **VENT RIB** gives you a smooth, clean sighting plane
- **SELF-ADJUSTING ACTIVE VALVE GAS SYSTEM** cycles a wide variety of loads while reducing felt recoil
- **QUADRA-VENT™ PORTS** vent excess gases for cleaner operation
- **DROP-OUT TRIGGER GROUP** allows for easy cleaning
- **AMBIDEXTROUS CROSSBOLT SAFETY** is easily reversible
- **LARGER BOLT HANDLE AND BOLT RELEASE BUTTON** are fast and easy to operate
- **PACHMAYR® DECELERATOR® RECOIL PAD** helps reduce flinch and fatigue



# NEW WATERFOWL HUNTER COMPACT



	ITEM NUMBER	GAUGE	BARREL LENGTH	CHAMBER	MAG CAP	CHOKE TUBES INCLUDED	OVERALL LENGTH	LENGTH OF PULL	DROP AT COMB	DROP AT HEEL	NOMINAL WT. (LBS)	SUGGESTED RETAIL
<b>SX4 COMPACT</b>												
NEW	511230390	12	24"	3"	4*	F, M, IC	43 3/4"	13"	1 3/4"	2"	6 1/2	\$799.99
NEW	511230391	12	26"	3"	4*	F, M, IC	45 3/4"	13"	1 3/4"	2"	6 5/8	799.99
NEW	511230392	12	28"	3"	4*	F, M, IC	47 3/4"	13"	1 3/4"	2"	6 3/4	799.99
NEW	511230690	20	24"	3"	4*	F, M, IC	43 3/4"	13"	1 3/4"	2"	6 1/4	939.99
NEW	511230691	20	26"	3"	4*	F, M, IC	45 3/4"	13"	1 3/4"	2"	6 3/8	939.99
NEW	511230692	20	28"	3"	4*	F, M, IC	47 3/4"	13"	1 3/4"	2"	6 1/2	939.99
<b>SX4 WATERFOWL HUNTER COMPACT (MOSSY OAK SHADOW GRASS BLADES)</b>												
NEW	511231390	12	24"	3"	4*	F, M, IC	43 3/4"	13"	1 3/4"	2"	6 1/2	\$939.99
NEW	511231391	12	26"	3"	4*	F, M, IC	45 3/4"	13"	1 3/4"	2"	6 5/8	939.99
NEW	511231392	12	28"	3"	4*	F, M, IC	47 3/4"	13"	1 3/4"	2"	6 3/4	939.99
NEW	511231690	20	24"	3"	4*	F, M, IC	43 3/4"	13"	1 3/4"	2"	6 1/4	1,069.99
NEW	511231691	20	26"	3"	4*	F, M, IC	45 3/4"	13"	1 3/4"	2"	6 3/8	1,069.99
NEW	511231692	20	28"	3"	4*	F, M, IC	47 3/4"	13"	1 3/4"	2"	6 1/2	1,069.99

\*TOTAL AMMUNITION CAPACITY INCLUDES ONE ADDITIONAL SHELL IN THE CHAMBER.

# SUPER X<sup>4</sup>

# GET SOME GAME.

A TRIO OF SUPER X<sup>4</sup> GAME-GETTING AUTOLOADERS FOR ANY SEASON.



NOW IN  
**20**  
GAUGE

## UNIVERSAL HUNTER



- **SYNTHETIC STOCK WITH IMPROVED ERGONOMICS, A ROUNDED PISTOL GRIP AND TEXTURED GRIPPING SURFACES** gives your hands a sure, non-slip grip. Full coverage Mossy Oak® Break-Up Country® camo finish means your shotgun will help give you ultimate concealment
- **BACK-BORED TECHNOLOGY** provides optimum shot patterns that are dense and even
- **INVECTOR-PLUS™ CHOKE TUBE SYSTEM** offers consistent patterns to match your target situation
- **HARD CHROME-PLATED CHAMBER AND BORE** make these surfaces highly resistant to corrosion and wear from steel shot
- **VENT RIB** gives you a smooth, clean sighting plane
- **DRILLED AND TAPPED ALLOY RECEIVER** is ready for optics mounting

- **TRUGLO® LONG BEAD™ FIBER-OPTIC FRONT SIGHT** offers a true, precise sight picture
- **SELF-ADJUSTING ACTIVE VALVE GAS SYSTEM** cycles a wide variety of loads while reducing felt recoil
- **QUADRA-VENT™ PORTS** vent excess gases for cleaner operation
- **DROP-OUT TRIGGER GROUP** allows for easy cleaning
- **AMBIDEXTROUS CROSSBOLT SAFETY** is easily reversible
- **LARGER BOLT HANDLE AND BOLT RELEASE BUTTON** are fast and easy to operate
- **LENGTH OF PULL SPACERS** allow stock adjustments to achieve a perfect fit
- **INFLEX TECHNOLOGY RECOIL PAD** directs felt recoil down and away from your cheek to reduce flinch and fatigue



## EXTRA-FULL TURKEY CHOKE TUBE

A tight, dense pattern of heavy shot is critical for taking turkeys. You get an Invector-Plus™ Extra-Full Turkey choke tube standard with the Super X®4 NWTF® Cantilever Turkey shotgun. The knurled friction band makes it easy to install and remove and the camo front band won't give you away to a sharp-eyed tom.



# NWTF® CANTILEVER TURKEY



- **SYNTHETIC STOCK WITH IMPROVED ERGONOMICS, A ROUNDED PISTOL GRIP AND TEXTURED GRIPPING SURFACES** gives your hands a sure, non-slip grip and the non-glare Mossy Oak® Obsession® camo finish helps you hide from turkeys
- **BACK-BORED TECHNOLOGY** provides optimum shot patterns that are dense and even
- **INVECTOR-PLUS™ EXTRA-FULL TURKEY EXTENDED CHOKE TUBE** with camo front band produces a tight, tom-busting pattern
- **24" BARREL** is easy to swing in tight brush
- **HARD CHROME-PLATED CHAMBER AND BORE** make these surfaces highly resistant to wear and corrosion
- **TRUGLO® FIBER-OPTIC FRONT SIGHT AND ADJUSTABLE REAR SIGHT** gather light for quick target acquisition

- **WEAVER®-STYLE CANTILEVER RAIL DESIGN** makes it easy to attach an electronic sight or conventional scope, and it retains its zero even when the barrel is removed for cleaning or transportation
- **SELF-ADJUSTING ACTIVE VALVE GAS SYSTEM** cycles a wide variety of loads while reducing felt recoil
- **QUADRA-VENT™ PORTS** vent excess gases for cleaner operation
- **DROP-OUT TRIGGER GROUP** allows for easy cleaning
- **AMBIDEXTROUS CROSSBOLT SAFETY** is easily reversible
- **LENGTH OF PULL SPACERS** allow stock adjustments to achieve a perfect fit
- **INFLEX TECHNOLOGY RECOIL PAD** directs felt recoil down and away from your cheek to reduce flinch and fatigue



# CANTILEVER BUCK



- **SYNTHETIC STOCK WITH IMPROVED ERGONOMICS, A ROUNDED PISTOL GRIP AND TEXTURED GRIPPING SURFACES** gives your hands a sure, non-slip grip and the non-glare matte black finish won't betray you to a big buck
- **RIFLED 22" BARREL** optimized for extreme accuracy with 2 3/4" and 3" sabots and slugs
- **MATTE BLACK RECEIVER** is strong, lightweight aluminum alloy for easy carrying
- **WEAVER®-STYLE CANTILEVER RAIL DESIGN** makes it easy to attach an electronic sight or conventional scope, and it retains its zero even when the barrel is removed for cleaning or transportation

- **TRUGLO® FIBER-OPTIC FRONT SIGHT AND ADJUSTABLE REAR SIGHT** gather light for quick target acquisition
- **SELF-ADJUSTING ACTIVE VALVE GAS SYSTEM** cycles a wide variety of loads while reducing felt recoil
- **DROP-OUT TRIGGER GROUP** allows for easy cleaning
- **AMBIDEXTROUS CROSSBOLT SAFETY** is easily reversible
- **LENGTH OF PULL SPACERS** allow stock adjustments to achieve a perfect fit
- **INFLEX TECHNOLOGY RECOIL PAD** directs felt recoil down and away from your cheek to reduce flinch and fatigue

ITEM NUMBER	GAUGE	BARREL LENGTH	CHAMBER	MAG CAP	CHOKE TUBES INCLUDED	OVERALL LENGTH	LENGTH OF PULL	DROP AT COMB	DROP AT HEEL	NOMINAL WT. (LBS)	SUGGESTED RETAIL	
<b>SX4 NWTF CANTILEVER TURKEY (MOSSY OAK OBSESSION)</b>												
511214290	12	24"	3 1/2"	4*	T	45"	14 1/4"	13/4"	2"	7 1/2	\$1,069.99	
<b>SX4 CANTILEVER BUCK</b>												
511215340	12	22"	3"	4*	1:28" RH Twist	43"	14 1/4"	13/4"	2"	7 1/2	\$959.99	
<b>SX4 UNIVERSAL HUNTER (MOSSY OAK BREAK-UP COUNTRY)</b>												
511216290	12	24"	3 1/2"	4*	F, M, IC	45"	14 1/4"	13/4"	2"	7	1,069.99	
511216291	12	26"	3 1/2"	4*	F, M, IC	47"	14 1/4"	13/4"	2"	7 1/8	1,069.99	
511216292	12	28"	3 1/2"	4*	F, M, IC	45"	14 1/4"	13/4"	2"	6 1/2	1,069.99	
<b>NEW</b>	511216690	20	24"	3"	4*	F, M, IC	47"	14 1/4"	13/4"	2"	6 5/8	1,069.99
<b>NEW</b>	511216691	20	26"	3"	4*	F, M, IC	47"	14 1/4"	13/4"	2"	6 3/4	1,069.99
<b>NEW</b>	511216692	20	28"	3"	4*	F, M, IC	49"	14 1/4"	13/4"	2"	1,069.99	

\*TOTAL AMMUNITION CAPACITY INCLUDES ONE ADDITIONAL SHELL IN THE CHAMBER.

# SX4

# SUPER X<sup>4</sup>

# GOOD WOOD.

HERE'S A PAIR THAT'S BUILT 4 SPEED, STOCKED IN FINE CHECKERED WALNUT.



LEFT-SIDE  
RECEIVER  
ENGRAVING.



	ITEM NUMBER	GAUGE	BARREL LENGTH	CHAMBER	MAG CAP	CHOKE TUBES INCLUDED	OVERALL LENGTH	LENGTH OF PULL	DROP AT COMB	DROP AT HEEL	NOMINAL WT. (LBS)	SUGGESTED RETAIL
<b>SX4 FIELD</b>												
	511210391	12	26"	3"	4*	F, M, IC	47"	14 1/4"	13/4"	2"	6 5/8	\$939.99
	511210392	12	28"	3"	4*	F, M, IC	49"	14 1/4"	13/4"	2"	6 3/4	939.99
<b>NEW</b>	511210691	20	26"	3"	4*	F, M, IC	47"	14 1/4"	13/4"	2"	6 3/8	1,069.99
<b>NEW</b>	511210692	20	28"	3"	4*	F, M, IC	49"	14 1/4"	13/4"	2"	6 1/2	1,069.99
<b>SX4 FIELD COMPACT</b>												
	511211390	12	24"	3"	4*	F, M, IC	43 3/4"	13"	13/4"	17/8"	6 3/8	\$939.99
	511211391	12	26"	3"	4*	F, M, IC	45 3/4"	13"	13/4"	17/8"	6 1/2	939.99
	511211392	12	28"	3"	4*	F, M, IC	47 3/4"	13"	13/4"	17/8"	6 5/8	939.99
<b>NEW</b>	511211690	20	24"	3"	4*	F, M, IC	43 3/4"	13"	13/4"	17/8"	6 1/4	1,069.99
<b>NEW</b>	511211691	20	26"	3"	4*	F, M, IC	45 3/4"	13"	13/4"	17/8"	6 3/8	1,069.99
<b>NEW</b>	511211692	20	28"	3"	4*	F, M, IC	47 3/4"	13"	13/4"	17/8"	6 1/2	1,069.99

\*TOTAL AMMUNITION CAPACITY INCLUDES ONE ADDITIONAL SHELL IN THE CHAMBER.



# FIELD & FIELD COMPACT

**NOW IN 20 GAUGE**



- **SATIN OIL FINISH WALNUT STOCK WITH STRAIGHT LINE CUT CHECKERING, IMPROVED ERGONOMICS AND A ROUNDED PISTOL GRIP** improves control and looks elegant
- **THE COMPACT MODEL OFFERS A REDUCED 13" LENGTH OF PULL** to better fit smaller statured shooters. Two 1/4" spacers are included to create a more custom fit
- **MATTE BLACK RECEIVER** is a strong, lightweight aluminum alloy to reduce weight for easy carrying
- **BACK-BORED TECHNOLOGY** provides optimum shot patterns that are dense and even
- **VENT RIB** gives you a smooth, clean sighting plane and helps reduce weight
- **TRUGLO® LONG BEAD™ FIBER-OPTIC FRONT SIGHT** offers a true, precise sight picture

- **HARD CHROME-PLATED CHAMBER AND BORE** make these surfaces highly resistant to wear and corrosion
- **INVECTOR-PLUS™ CHOKE TUBES** offer consistent, reliable patterns
- **SELF-ADJUSTING ACTIVE VALVE GAS SYSTEM** cycles a wide variety of loads while reducing felt recoil
- **INFLEX TECHNOLOGY RECOIL PAD** directs felt recoil down and away from your cheek to reduce flinch and fatigue
- **AMBIDEXTROUS CROSSBOLT SAFETY** is easily reversible
- **LARGER BOLT HANDLE AND BOLT RELEASE BUTTON** are fast and easy to operate
- **DROP-OUT TRIGGER GROUP** allows for easy cleaning



# NEW UPLAND FIELD



- **SATIN OIL FINISH GRADE II/III WALNUT STOCK WITH STRAIGHT LINE CUT CHECKERING, IMPROVED ERGONOMICS AND A ROUNDED PISTOL GRIP** improves control and looks elegant
- **MATTE NICKEL-PLATED RECEIVER WITH ENGRAVED UPLAND GAME SCENE** is a strong, lightweight aluminum alloy to reduce weight for easy carrying
- **BACK-BORED TECHNOLOGY** provides optimum shot patterns that are dense and even
- **VENT RIB** gives you a smooth, clean sighting plane and helps reduce weight
- **TRUGLO® LONG BEAD™ FIBER-OPTIC FRONT SIGHT** offers a true, precise sight picture

- **HARD CHROME-PLATED CHAMBER AND BORE** make these surfaces highly resistant to wear and corrosion
- **INVECTOR-PLUS™ CHOKE TUBES** offer consistent, reliable patterns
- **SELF-ADJUSTING ACTIVE VALVE GAS SYSTEM** cycles a wide variety of loads while reducing felt recoil
- **INFLEX TECHNOLOGY RECOIL PAD** directs felt recoil down and away from your cheek to reduce flinch and fatigue
- **AMBIDEXTROUS CROSSBOLT SAFETY** is easily reversible
- **LARGER BOLT HANDLE AND BOLT RELEASE BUTTON** are fast and easy to operate
- **DROP-OUT TRIGGER GROUP** allows for easy cleaning

ITEM NUMBER	GAUGE	BARREL LENGTH	CHAMBER	MAG CAP	CHOKE TUBES INCLUDED	OVERALL LENGTH	LENGTH OF PULL	DROP AT COMB	DROP AT HEEL	NOMINAL WT. (LBS)	SUGGESTED RETAIL
<b>SX4 UPLAND FIELD</b>											
<b>NEW</b> 511236391	12	26"	3"	4*	F, M, IC	47"	14 1/4"	13 3/4"	2"	7	\$1,109.99
<b>NEW</b> 511236392	12	28"	3"	4*	F, M, IC	49"	14 1/4"	13 3/4"	2"	7 1/8	1,109.99

\*TOTAL AMMUNITION CAPACITY INCLUDES ONE ADDITIONAL SHELL IN THE CHAMBER.

# SUPER X<sup>®</sup> PUMP

**HERE'S WHAT MAKES IT THE FASTEST PUMP ON THE PLANET.**

What you hear is the sound of quality and rugged reliability when you shuck a shell into a Winchester<sup>®</sup> Super X<sup>®</sup> Pump shotgun. What you feel is the silky smoothness that comes from the Super X Pump shotgun's inertia-assisted action. Its unique design cycles so fast you'll think you're shooting an autoloader — and will boost your confidence in each and every shooting situation.

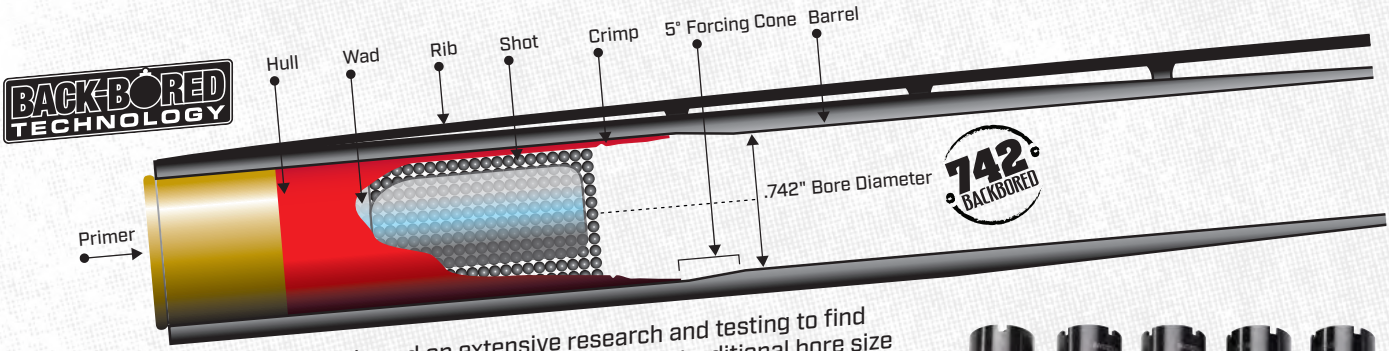

**BACK-BORED TECHNOLOGY** is based on extensive research and testing to find the secret to tighter, more consistent patterns. Instead of the traditional bore size of .729", this research shows the ideal 12 gauge interior diameter is .742". In 20 gauge barrels the ideal bore diameter is .630" instead of the standard .618". If the bore is any larger the gases will blow by the shot cup and reduce pellet velocity. If the bore is too tight the pellets are deformed as they pass through the forcing cone, causing poor ballistic performance.



**CHROME-PLATED CHAMBER AND BORE** are critical for today's steel and Hi-Density (HD) shot. Hard chrome makes the surfaces highly resistant to wear and gives you superior protection from rust and corrosion. That's why all smoothbore Super X<sup>®</sup> Pump shotguns feature a hard-chromed chamber and bore.

From the duck blind to the firing line, the **INVECTOR-PLUS<sup>™</sup> CHOKE TUBE SYSTEM** is the world's most consistent. The Super X<sup>®</sup> Pump comes with full, modified and improved cylinder flush-mounted choke tubes so your gun is ready for anything, right out of the box.





**SPEED-PLUG SYSTEM** lets you remove the three-shot adaptor with your fingers. Just remove the magazine cap, push on the spring retainer holding the spring in place, twist and remove the adaptor. It's a trouble-free design that lets you "pull the plug" in mere seconds without any tools.

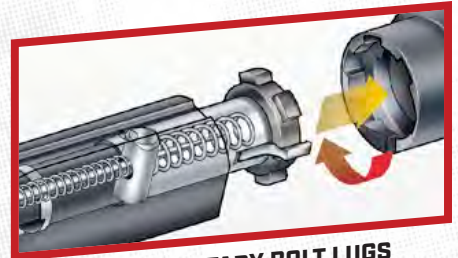

Four massive **ROTARY BOLT LUGS** provide support, strength and solid lockup in the barrel of the lightning-fast Super X<sup>®</sup> Pump. Under recoil, the mass of your body slows the rearward travel of the shotgun, while the inertial motion of the bolt, slide and forearm continue cycling the action to give you a head start ejecting the fired shell. Robust dual steel action guide bars eliminate the twisting and binding that waste time and energy when cycling the action.



**DROP-OUT TRIGGER GROUP** lets you remove one pin and pull the complete trigger system out for cleaning, lubrication and inspection. It's an easy way to keep your Super X<sup>®</sup> Pump shotgun in top shape, regardless of nasty weather or gritty shooting conditions.



The Super X<sup>®</sup> Pump has the best recoil pad ever put on a shotgun. Directional rib structures inside the **INFLEX TECHNOLOGY RECOIL PAD** help channel the recoil impulse by moving the comb down and away from your cheek. The pad's smooth textured surface makes shouldering the Super X Pump snag free regardless of what clothing you're wearing.



The **CROSSBOLT SAFETY** button on the Super X<sup>®</sup> Pump is located on the front of the trigger guard for easy access, even when you're wearing heavy waterfowling gloves.

**BLACK CHROME FINISH** on the bolt, barrel, slide, action bars and other parts protects better than conventional bluing and stands up to years of wear and harsh conditions.



**DURABLE E-COATING** on the magazine tube helps protect it from wear and corrosion to keep it looking sharp for years to come.



**THE NEW SUPER X<sup>®</sup> PUMP YOUTH FIELD MODEL HAS A SUPER COMPACT 12" LENGTH OF PULL** to better fit younger and small statured shooters.

SUPER X® PUMP

# SPEED TRAPS.

WHEN YOU'RE SHOOTING A WINCHESTER® SUPER X® PUMP, YOU'LL SHATTER EVERY CLAY WITH CONFIDENCE.







# TRAP

**BACK-BORED TECHNOLOGY** TRUGLO

- **SATIN FINISHED STOCK WITH A HIGH PROFILE TRAP COMB AND FOREARM WITH TRADITIONAL CHECKERING** provide a sure grip when the trapshooting action gets fast and furious
- **BACK-BORED TECHNOLOGY** provides optimum shot patterns, even from the 27 yard line
- **INVECTOR-PLUS™ CHOKE TUBE SYSTEM** offers consistent patterns to match your shooting situation
- **HARD CHROME-PLATED CHAMBER AND BORE** make surfaces highly resistant to wear and corrosion from thousands of shells
- **BLACK CHROME PROTECTION** on the bolt and other components lasts longer than traditional bluing

- **5/16" TRAP RIB WITH TRUGLO® FIBER-OPTIC FRONT SIGHT AND AN IVORY MID-BEAD** produce a crisp sight picture on both rising and crossing targets
- **3-SHOT ADAPTOR WITH SPEED-PLUG SYSTEM** is easily removed without tools
- **DROP-OUT TRIGGER GROUP** allows for easy cleaning
- **CROSSBOLT SAFETY** is easily operated
- **INFLEX TECHNOLOGY RECOIL PAD** directs felt recoil down and away from your cheek to help reduce flinch and fatigue, especially important when you're going for 100 straight targets



# TRAP COMPACT

**BACK-BORED TECHNOLOGY**

- **SATIN FINISHED STOCK WITH A HIGH PROFILE TRAP COMB AND FOREARM WITH TRADITIONAL CHECKERING** provide a sure grip when the trapshooting action gets fast and furious
- **COMPACT 13" LENGTH OF PULL BUTTSTOCK** makes it an ideal shotgun for younger shooters or those of smaller stature
- **BACK-BORED TECHNOLOGY** provides optimum shot patterns, even from the 27 yard line
- **INVECTOR-PLUS™ CHOKE TUBE SYSTEM** offers consistent patterns to match your shooting situation
- **HARD CHROME-PLATED CHAMBER AND BORE** make surfaces highly resistant to wear and corrosion from thousands of shells
- **BLACK CHROME PROTECTION** on the bolt and other components lasts longer than traditional bluing

- **5/16" TRAP RIB WITH TRUGLO® FIBER-OPTIC FRONT SIGHT AND AN IVORY MID-BEAD** produce a crisp sight picture on both rising and crossing targets
- **3-SHOT ADAPTOR WITH SPEED-PLUG SYSTEM** is easily removed without tools
- **DROP-OUT TRIGGER GROUP** allows for easy cleaning
- **CROSSBOLT SAFETY** is easily operated
- **INFLEX TECHNOLOGY RECOIL PAD** directs felt recoil down and away from your cheek to help reduce flinch and fatigue, especially important when you're going for 100 straight targets

	ITEM NUMBER	GAUGE	BARREL LENGTH	CHAMBER	MAG CAP	CHOKE TUBES INCLUDED	OVERALL LENGTH	LENGTH OF PULL	DROP AT COMB	DROP AT HEEL	NOMINAL WT. (LBS)	SUGGESTED RETAIL
<b>SXP TRAP</b>	512296393	12	30"	3"	4*	F, IM, M	51"	14 1/4"	13/8"	2 1/8"	7 1/2	\$479.99
	512296394	12	32"	3"	4*	F, IM, M	53"	14 1/4"	13/8"	2 1/8"	7 5/8	479.99
<b>SXP TRAP COMPACT</b>	512297392	12	28"	3"	4*	F, IM, M	47 3/4"	13"	13/8"	2 1/8"	7 1/4	\$479.99
	512297393	12	30"	3"	4*	F, IM, M	49 3/4"	13"	13/8"	2 1/8"	7 3/8	479.99
	512297692	20	28"	3"	4*	F, IM, M	47 3/4"	13"	13/8"	2 1/8"	7 3/8	519.99
	512297693	20	30"	3"	4*	F, IM, M	49 3/4"	13"	13/8"	2 1/8"	7 3/8	519.99

\*TOTAL AMMUNITION CAPACITY INCLUDES ONE ADDITIONAL SHELL IN THE CHAMBER.



# MORE SPEED A FIELD.

THESE SUPER X® PUMP SHOTGUNS ARE FAST IN THE FIELD FOR SHOOTERS OF EVERY AGE AND SIZE.

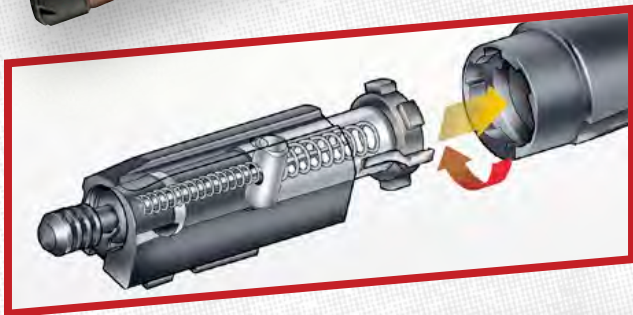

Four massive **ROTARY BOLT LUGS** provide support, strength and solid lockup in the barrel of the lightning-fast Super X® Pump shotgun. Under recoil, the mass of your body slows the rearward travel of the shotgun, while the inertial motion of the bolt, slide and forearm continue cycling the action to give you a head start ejecting the fired shell. Robust dual steel action guide bars eliminate the twisting and binding that waste time and energy when cycling the action.



ITEM NUMBER	GAUGE	BARREL LENGTH	CHAMBER	MAG CAP	CHOKE TUBES INCLUDED	OVERALL LENGTH	LENGTH OF PULL	DROP AT COMB	DROP AT HEEL	NOMINAL WT. (LBS)	SUGGESTED RETAIL
<b>SXP FIELD</b>											
512266391	12	26"	3"	4*	F, M, IC	46 3/4"	14"	15/8"	2"	7	\$399.99
512266392	12	28"	3"	4*	F, M, IC	48 3/4"	14"	15/8"	2"	7 1/8	399.99
512266691	20	26"	3"	5*	F, M, IC	46 3/4"	14"	15/8"	2"	6 3/4	429.99
512266692	20	28"	3"	5*	F, M, IC	48 3/4"	14"	15/8"	2"	6 7/8	429.99
<b>SXP FIELD COMPACT</b>											
512287390	12	24"	3"	4*	F, M, IC	43 1/2"	13"	15/8"	2"	6 1/2	\$399.99
512271391	12	26"	3"	4*	F, M, IC	45 1/2"	13"	15/8"	2"	6 5/8	399.99
512271392	12	28"	3"	4*	F, M, IC	47 1/2"	13"	15/8"	2"	6 3/4	399.99
512271690	20	24"	3"	5*	F, M, IC	43 1/2"	13"	15/8"	2"	6 3/8	429.99
512271691	20	26"	3"	5*	F, M, IC	45 1/2"	13"	15/8"	2"	6 1/2	429.99
512271692	20	28"	3"	5*	F, M, IC	47 1/2"	13"	15/8"	2"	6 5/8	429.99

\*TOTAL AMMUNITION CAPACITY INCLUDES ONE ADDITIONAL SHELL IN THE CHAMBER.



# FIELD & FIELD COMPACT



- **SATIN FINISHED STOCK AND FOREARM WITH TRADITIONAL CHECKERING** provide a sure grip when the hunting action gets hot. The Compact model has a reduced 13" length of pull making it ideal for younger shooters or those of smaller stature
- **BACK-BORED TECHNOLOGY** provides optimum shot patterns that are dense and even
- **3" CHAMBER** gives you the added range to knock down game with heavy hunting loads
- **INVECTOR-PLUS™ CHOKE TUBE SYSTEM** offers consistent patterns to match your game and situation
- **HARD CHROME-PLATED CHAMBER AND BORE** make surfaces highly resistant to wear and corrosion

- **BLACK CHROME PROTECTION** on the bolt and other components lasts longer than traditional bluing
- **BRASS FRONT SIGHT BEAD** offers a fast, natural sight picture
- **3-SHOT ADAPTOR WITH SPEED-PLUG SYSTEM** is easily removed without tools
- **DROP-OUT TRIGGER GROUP** allows for easy cleaning
- **CROSSBOLT SAFETY** is easily operated
- **INFLEX TECHNOLOGY RECOIL PAD** directs felt recoil down and away from your cheek to reduce flinch and fatigue



# NEW YOUTH FIELD



- **SUPER COMPACT 12" LENGTH OF PULL** to better fit younger and small statured shooters
- **SATIN FINISHED STOCK AND FOREARM WITH TRADITIONAL CHECKERING** provide a sure grip when the hunting action gets hot
- **BACK-BORED TECHNOLOGY** provides optimum shot patterns that are dense and even
- **3" CHAMBER** gives you the added range to knock down game with heavy hunting loads
- **INVECTOR-PLUS™ CHOKE TUBE SYSTEM** offers consistent patterns to match your game and situation
- **HARD CHROME-PLATED CHAMBER AND BORE** make surfaces highly resistant to wear and corrosion

- **BLACK CHROME PROTECTION** on the bolt and other components lasts longer than traditional bluing
- **BRASS FRONT SIGHT BEAD** offers a fast, natural sight picture
- **3-SHOT ADAPTOR WITH SPEED-PLUG SYSTEM** is easily removed without tools
- **DROP-OUT TRIGGER GROUP** allows for easy cleaning
- **CROSSBOLT SAFETY** is easily operated
- **INFLEX TECHNOLOGY RECOIL PAD** directs felt recoil down and away from your cheek to reduce flinch and fatigue

	ITEM NUMBER	GAUGE	BARREL LENGTH	CHAMBER	MAG CAP	CHOKE TUBES INCLUDED	OVERALL LENGTH	LENGTH OF PULL	DROP AT COMB	DROP AT HEEL	NOMINAL WT. (LBS)	SUGGESTED RETAIL
<b>SXP YOUTH FIELD</b>												
<b>NEW</b>	512367302	12	20"	3"	4*	F, M, IC	38 3/4"	12"	15/8"	2"	6 1/8	\$399.99
<b>NEW</b>	512367303	12	22"	3"	4*	F, M, IC	40 3/4"	12"	15/8"	2"	6 1/4	399.99
<b>NEW</b>	512367390	12	24"	3"	4*	F, M, IC	42 3/4"	12"	15/8"	2"	6 3/8	429.99
<b>NEW</b>	512367390	12	24"	3"	4*	F, M, IC	36 3/4"	12"	15/8"	2"	5 7/8	429.99
<b>NEW</b>	512367601	20	18"	3"	4*	F, M, IC	38 3/4"	12"	15/8"	2"	6	429.99
<b>NEW</b>	512367602	20	20"	3"	4*	F, M, IC	40 3/4"	12"	15/8"	2"	6 1/8	429.99
<b>NEW</b>	512367603	20	22"	3"	4*	F, M, IC	42 3/4"	12"	15/8"	2"	6 1/4	429.99
<b>NEW</b>	512367690	20	24"	3"	4*	F, M, IC	42 3/4"	12"	15/8"	2"	6 1/4	429.99

\*TOTAL AMMUNITION CAPACITY INCLUDES ONE ADDITIONAL SHELL IN THE CHAMBER.



# HUNT FOR ANYTHING.

THESE GUNS ARE IDEAL FOR ANY SEASON.



The receiver on the Winchester® Super X® Pump Universal Hunter shotgun is drilled and tapped for optional Winchester scope bases and rings. See the full line of bases and rings on page 77.

ITEM NUMBER	GAUGE	BARREL LENGTH	CHAMBER	MAG CAP	CHOKE TUBES INCLUDED	OVERALL LENGTH	LENGTH OF PULL	DROP AT COMB	DROP AT HEEL	NOMINAL WT. (LBS)	SUGGESTED RETAIL
<b>SXP WATERFOWL HUNTER (MOSSY OAK SHADOW GRASS BLADES)</b>											
512270291	12	26"	3 1/2"	4*	F, M, IC	47"	13 3/4"	1 5/8"	2"	6 7/8	\$499.99
512270292	12	28"	3 1/2"	4*	F, M, IC	49"	13 3/4"	1 5/8"	2"	7	499.99
512270391	12	26"	3"	4*	F, M, IC	46 1/2"	13 3/4"	1 5/8"	2"	6 3/4	459.99
512270392	12	28"	3"	4*	F, M, IC	48 1/2"	13 3/4"	1 5/8"	2"	6 7/8	459.99
512270691	20	26"	3"	5*	F, M, IC	46 1/2"	13 3/4"	1 5/8"	2"	6 1/2	499.99
512270692	20	28"	3"	5*	F, M, IC	48 1/2"	13 3/4"	1 5/8"	2"	6 5/8	499.99

\*TOTAL AMMUNITION CAPACITY INCLUDES ONE ADDITIONAL SHELL IN THE CHAMBER.



# WATERFOWL HUNTER



**BACKBORED TECHNOLOGY**

**TRUGLO**

- **SYNTHETIC STOCK WITH TEXTURED GRIPPING SURFACES** gives your hands a sure, non-slip grip and the non-glare Mossy Oak® Shadow Grass Blades finish won't spook wary waterfowl
- **BACK-BORED TECHNOLOGY** provides optimum shot patterns that are dense and even
- **3" AND 3 1/2" CHAMBER** models give you the magnum advantage to reach out for long-range waterfowl
- **INVECTOR-PLUS™ CHOKE TUBE SYSTEM** offers consistent patterns to match your game and situation
- **HARD CHROME-PLATED CHAMBER AND BORE** make these surfaces highly resistant to wear and corrosion

- **BLACK CHROME PROTECTION** on the bolt and other components lasts longer than traditional bluing
- **TRUGLO® LONG BEAD™ FIBER-OPTIC FRONT SIGHT** offers a true, precise sight picture
- **3-SHOT ADAPTOR WITH SPEED-PLUG SYSTEM** is easily removed without tools
- **ROTARY BOLT** with four massive lugs provides strength, support and solid lockup
- **DROP-OUT TRIGGER GROUP** allows for easy cleaning
- **CROSSBOLT SAFETY** is easily operated, even with gloves
- **INFLEX TECHNOLOGY RECOIL PAD** directs felt recoil down and away from your cheek to reduce flinch and fatigue



# UNIVERSAL HUNTER



**BACKBORED TECHNOLOGY**

**TRUGLO**

- **SYNTHETIC STOCK WITH TEXTURED GRIPPING SURFACES** gives your hands a sure, non-slip grip and the non-glare Mossy Oak® Break-Up Country® camo finish won't spook wary game
- **BACK-BORED TECHNOLOGY** provides optimum shot patterns that are dense and even
- **3" AND 3 1/2" CHAMBER** models give you the magnum advantage to reach out for long-range birds and game
- **INVECTOR-PLUS™ CHOKE TUBE SYSTEM** offers consistent patterns to match your game and situation
- **HARD CHROME-PLATED CHAMBER AND BORE** make these surfaces highly resistant to wear and corrosion
- **DRILLED AND TAPPED ALLOY RECEIVER** is ready for optics mounting

- **BLACK CHROME PROTECTION** on the bolt and other components lasts longer than traditional bluing
- **TRUGLO® LONG BEAD™ FIBER-OPTIC FRONT SIGHT** offers a true, precise sight picture
- **3-SHOT ADAPTOR WITH SPEED-PLUG SYSTEM** is easily removed without tools
- **ROTARY BOLT** with four massive lugs provides strength, support and solid lockup
- **DROP-OUT TRIGGER GROUP** allows for easy cleaning
- **CROSSBOLT SAFETY** is easily operated, even with gloves
- **INFLEX TECHNOLOGY RECOIL PAD** directs felt recoil down and away from your cheek to reduce flinch and fatigue

ITEM NUMBER	GAUGE	BARREL LENGTH	CHAMBER	MAG CAP	CHOKE TUBES INCLUDED	OVERALL LENGTH	LENGTH OF PULL	DROP AT COMB	DROP AT HEEL	NOMINAL WT. (LBS)	SUGGESTED RETAIL
<b>SXP UNIVERSAL HUNTER (MOSSY OAK BREAK-UP COUNTRY)</b>											
512321290	12	24"	3 1/2"	4*	F, M, IC	45"	13 3/4"	15/8"	2"	6 3/4	\$509.99
512321291	12	26"	3 1/2"	4*	F, M, IC	47"	13 3/4"	15/8"	2"	6 7/8	509.99
512321292	12	28"	3 1/2"	4*	F, M, IC	49"	13 3/4"	15/8"	2"	7	509.99
512321390	12	24"	3"	4*	F, M, IC	44 1/2"	13 3/4"	15/8"	2"	6 5/8	469.99
512321391	12	26"	3"	4*	F, M, IC	46 1/2"	13 3/4"	15/8"	2"	6 7/8	469.99
512321392	12	28"	3"	4*	F, M, IC	48 1/2"	13 3/4"	15/8"	2"	6 3/8	509.99
512321690	20	24"	3"	5*	F, M, IC	44 1/2"	13 3/4"	15/8"	2"	6 1/2	509.99
512321691	20	26"	3"	5*	F, M, IC	46 1/2"	13 3/4"	15/8"	2"	6 5/8	509.99
512321692	20	28"	3"	5*	F, M, IC	48 1/2"	13 3/4"	15/8"	2"	6 5/8	509.99

\*TOTAL AMMUNITION CAPACITY INCLUDES ONE ADDITIONAL SHELL IN THE CHAMBER.



SUPER X® PUMP

# SHADES OF SUCCESS.

YOUR NEXT HUNTING ADVENTURE IS WAITING FOR YOU IN THESE SHADOWS.



The receiver on the Winchester® Super X® Pump Black Shadow® Deer shotgun is drilled and tapped for Winchester scope bases and rings. See the full line of bases and rings on page 77.





# BLACK SHADOW<sup>®</sup>



- **SYNTHETIC STOCK WITH TEXTURED GRIPPING SURFACES** gives your hands a sure, non-slip grip and the non-glare matte black finish won't spook wary game
- **BACK-BORED TECHNOLOGY** provides optimum shot patterns that are dense and even
- **3" AND 3 1/2" CHAMBER** 12 gauge models give you the magnum advantage to reach out for long-range game
- **INVECTOR-PLUS™ CHOKE TUBE SYSTEM** offers consistent patterns to match your game and situation
- **HARD CHROME-PLATED CHAMBER AND BORE** make these surfaces highly resistant to wear and corrosion
- **BLACK CHROME PROTECTION** on the bolt and other components lasts longer than traditional bluing

- **BRASS FRONT SIGHT BEAD** offers a fast, natural sight picture
- **3-SHOT ADAPTOR WITH SPEED-PLUG SYSTEM** is easily removed without tools
- **ROTARY BOLT** with four massive lugs provides strength and solid lockup
- **DROP-OUT TRIGGER GROUP** allows for easy cleaning
- **CROSSBOLT SAFETY** is easily operated, even with gloves
- **INFLEX TECHNOLOGY RECOIL PAD** directs felt recoil down and away from your cheek to reduce flinch and fatigue



# BLACK SHADOW<sup>®</sup> DEER

**TRUGLO**

- **SYNTHETIC STOCK WITH TEXTURED GRIPPING SURFACES** gives your hands a sure, non-slip grip and the non-glare matte black finish won't spook wary game
- **22" FULLY-RIFLED BARREL** is designed to provide optimum accuracy with modern sabots and slugs
- **3" CHAMBER** gives you the ability to reach out for challenging shots
- **BLACK CHROME PROTECTION** on the bolt and other components lasts longer than traditional bluing
- **TRUGLO<sup>®</sup> FIBER-OPTIC FRONT SIGHT AND ADJUSTABLE FIBER-OPTIC REAR SIGHT** offer a fast, natural sight picture

- **DRILLED AND TAPPED ALLOY RECEIVER** is ready for optics mounting
- **3-SHOT ADAPTOR WITH SPEED-PLUG SYSTEM** is easily removed without tools
- **ROTARY BOLT** with four massive lugs provides strength, support and solid lockup
- **DROP-OUT TRIGGER GROUP** allows for easy cleaning
- **CROSSBOLT SAFETY** is easily operated, even with gloves
- **INFLEX TECHNOLOGY RECOIL PAD** directs felt recoil down and away from your cheek to reduce flinch and fatigue

ITEM NUMBER	GAUGE	BARREL LENGTH	CHAMBER	MAG CAP	CHOKE TUBES INCLUDED	OVERALL LENGTH	LENGTH OF PULL	DROP AT COMB	DROP AT HEEL	NOMINAL WT. (LBS)	SUGGESTED RETAIL
<b>SXP BLACK SHADOW</b>											
512251290	12	24"	3 1/2"	4*	F, M, IC	45"	13 3/4"	15/8"	2"	6 3/4	\$399.99
512251291	12	26"	3 1/2"	4*	F, M, IC	47"	13 3/4"	15/8"	2"	6 7/8	399.99
512251292	12	28"	3 1/2"	4*	F, M, IC	49"	13 3/4"	15/8"	2"	7	399.99
512251390	12	24"	3"	4*	F, M, IC	44 1/2"	13 3/4"	15/8"	2"	6 5/8	379.99
512251391	12	26"	3"	4*	F, M, IC	46 1/2"	13 3/4"	15/8"	2"	6 3/4	379.99
512251392	12	28"	3"	4*	F, M, IC	48 1/2"	13 3/4"	15/8"	2"	6 7/8	399.99
512251690	20	24"	3"	5*	F, M, IC	44 1/2"	13 3/4"	15/8"	2"	6 3/8	399.99
512251691	20	26"	3"	5*	F, M, IC	46 1/2"	13 3/4"	15/8"	2"	6 1/2	399.99
512251692	20	28"	3"	5*	F, M, IC	48 1/2"	13 3/4"	15/8"	2"	6 5/8	399.99
<b>SXP BLACK SHADOW DEER</b>											
512261340	12	22"	3"	4**	1:35" RH Twist	43"	13 3/4"	15/8"	2"	6 7/8	\$519.99
512261640	20	22"	3"	5**	1:24" RH Twist	43"	13 3/4"	15/8"	2"	6 5/8	549.99

\*TOTAL AMMUNITION CAPACITY INCLUDES ONE ADDITIONAL SHELL IN THE CHAMBER.  
 \*\*MAGAZINE CAPACITY DEPENDS ON SHELL LENGTH. SOME SLUGS ARE LONGER THAN STANDARD 2 3/4" SHOT SHELLS.



SUPER X® PUMP

# RUGGED AND READY.

GET A GRIP AND LET IT RIP WITH FAST, INERTIA-ASSISTED PUMP ACTION FROM THE MOST ERGONOMIC PISTOL GRIP STOCK AVAILABLE.



Two user-interchangeable combs and height adjustment spacers let you tune the comb height on your Super X® Pump Extreme Deer for perfect eye-to-sight alignment with your choice of sighting systems.







The receivers on both Winchester® Super X® Pump Extreme Deer shotgun models are drilled and tapped for Winchester scope bases and rings, allowing you to easily attach an optional scope or electronic sight to fully utilize the incredible accuracy of today's shotgun slug ammo. See the full line of bases and rings on page 77.



## EXTREME DEER

TRUGLO

- **SYNTHETIC PISTOL GRIP STOCK WITH TEXTURED GRIPPING SURFACES** gives your hands a sure, non-slip grip and the non-glare matte black finish won't spook wary game
- **TWO INTERCHANGEABLE COMB PIECES** allow you to fine-tune drop at comb for use with iron, electronic or optical sights
- **TWO INTERCHANGEABLE LENGTH OF PULL SPACERS** allow you to fine-tune length of pull for a perfect stock fit
- **22" FULLY-RIFLED BARREL** is designed to provide optimum accuracy with modern sabots and slugs
- **3" CHAMBER** gives you the ability to reach out for challenging shots
- **BLACK CHROME PROTECTION** on the bolt and other components lasts longer than traditional bluing

- **TRUGLO® FIBER-OPTIC FRONT SIGHT AND ADJUSTABLE FIBER-OPTIC REAR SIGHT** offer a fast, natural sight picture
- **DRILLED AND TAPPED ALLOY RECEIVER** is ready for optics mounting
- **3-SHOT ADAPTOR WITH SPEED-PLUG SYSTEM** is easily removed without tools
- **ROTARY BOLT** with four massive lugs provides strength, support and solid lockup
- **DROP-OUT TRIGGER GROUP** allows for easy cleaning
- **CROSSBOLT SAFETY** is easily operated, even with gloves
- **INFLEX TECHNOLOGY RECOIL PAD** directs felt recoil down and away from your cheek to reduce flinch and fatigue



## EXTREME DEER HUNTER

TRUGLO

- **SYNTHETIC PISTOL GRIP STOCK WITH TEXTURED GRIPPING SURFACES** gives your hands a sure, non-slip grip and the Mossy Oak® Break-Up Country® camo finish won't spook wary game
- **TWO INTERCHANGEABLE COMB PIECES** allow you to fine-tune drop at comb for use with iron, electronic or optical sights
- **TWO INTERCHANGEABLE LENGTH OF PULL SPACERS** allow you to fine-tune length of pull for a perfect stock fit
- **22" FULLY-RIFLED BARREL** is designed to provide optimum accuracy with modern sabots and slugs
- **3" CHAMBER** gives you the ability to reach out for challenging shots
- **BLACK CHROME PROTECTION** on the bolt and other components lasts longer than traditional bluing

- **TRUGLO® FIBER-OPTIC FRONT SIGHT AND ADJUSTABLE FIBER-OPTIC REAR SIGHT** offer a fast, natural sight picture
- **DRILLED AND TAPPED ALLOY RECEIVER** is ready for optics mounting
- **3-SHOT ADAPTOR WITH SPEED-PLUG SYSTEM** is easily removed without tools
- **ROTARY BOLT** with four massive lugs provides strength, support and solid lockup
- **DROP-OUT TRIGGER GROUP** allows for easy cleaning
- **CROSSBOLT SAFETY** is easily operated, even with gloves
- **INFLEX TECHNOLOGY RECOIL PAD** directs felt recoil down and away from your cheek to reduce flinch and fatigue

ITEM NUMBER	GAUGE	BARREL LENGTH	CHAMBER	MAG CAP	RATE OF TWIST	OVERALL LENGTH	LENGTH OF PULL	DROP AT COMB	DROP AT HEEL	NOMINAL WT. (LBS)	SUGGESTED RETAIL
<b>SXP EXTREME DEER</b>											
512312340	12	22"	3"	4**	1:35" RH Twist	43"	13 3/4"	1 3/4"	2"	7	\$559.99
<b>SXP EXTREME DEER HUNTER (MOSSY OAK BREAK-UP COUNTRY)</b>											
512313240	12	22"	3"	4**	1:35" RH Twist	43"	13 3/4"	1 3/4"	2"	7	\$619.99

\*TOTAL AMMUNITION CAPACITY INCLUDES ONE ADDITIONAL SHELL IN THE CHAMBER.  
 \*\*MAGAZINE CAPACITY DEPENDS ON SHELL LENGTH. SOME SLUGS ARE LONGER THAN STANDARD 2 3/4" SHOT SHELLS.



# THE BEST DEFENSE.

SERIOUS HOME DEFENSE STARTS WITH THESE TWO HIGH-TECH PUMPS.



ITEM NUMBER	GAUGE	BARREL LENGTH	CHAMBER	MAG CAP	CHOKE TUBES INCLUDED	OVERALL LENGTH	LENGTH OF PULL	DROP AT COMB	DROP AT HEEL	NOMINAL WT. (LBS)	SUGGESTED RETAIL
<b>SXP SHADOW DEFENDER</b>											
512327395	12	18"	3"	5*	CYL	38 1/2"	13 3/4"	13/8"	15/8"	6 1/4	\$449.99
512327695	20	18"	3"	5*	CYL	38 1/2"	13 3/4"	13/8"	15/8"	6	469.99
<b>SXP SHADOW MARINE DEFENDER</b>											
512328395	12	18"	3"	5*	CYL	38 1/2"	13 3/4"	13/8"	15/8"	6 1/4	\$499.99
512328695	20	18"	3"	5*	CYL	38 1/2"	13 3/4"	13/8"	15/8"	6	519.99

\*TOTAL AMMUNITION CAPACITY INCLUDES ONE ADDITIONAL SHELL IN THE CHAMBER.



The receivers on both Winchester® Super X® Pump Shadow Defender™ shotgun models are drilled and tapped for Winchester scope bases and rings, allowing you to easily attach an optional scope or electronic sight to fully utilize the incredible accuracy of today's shotgun slug ammo. See the full line of bases and rings on page 77.



## SHADOW DEFENDER™



- **SYNTHETIC PISTOL GRIP STOCK WITH TEXTURED GRIPPING SURFACES** gives your hands a sure, non-slip grip and the non-glare matte black finish won't give you away
- **TWO INTERCHANGEABLE COMB PIECES** allow you to fine-tune drop at comb for use with iron, electronic or optical sights
- **TWO INTERCHANGEABLE LENGTH OF PULL SPACERS** allow you to fine-tune length of pull for a perfect stock fit
- **TACTICAL RIBBED FOREARM** for better control when you need it most
- **HARD CHROME-PLATED CHAMBER AND BORE** make these surfaces highly resistant to wear and corrosion
- **INVECTOR-PLUS™ CYLINDER CHOKE TUBE** handles both slugs and buckshot

- **3" CHAMBER** gives you the ability to reach out for challenging shots
- **BLACK CHROME PROTECTION** on the bolt and other components lasts longer than traditional bluing
- **REMOVABLE TRUGLO® FIBER-OPTIC FRONT SIGHT** plus a traditional brass front bead offer a fast, natural sight picture
- **DRILLED AND TAPPED ALLOY RECEIVER** is ready for optics mounting
- **ROTARY BOLT** with four massive lugs provides strength, support and solid lockup
- **CROSSBOLT SAFETY** is easily operated, even with gloves
- **INFLEX TECHNOLOGY RECOIL PAD** directs felt recoil down and away from your cheek to reduce flinch and fatigue



## SHADOW MARINE DEFENDER™



- **MATTE HARD CHROME PLATING** on the barrel, magazine tube and slide arms for added resistance to wear and the elements
- **SYNTHETIC PISTOL GRIP STOCK WITH TEXTURED GRIPPING SURFACES** gives your hands a sure, non-slip grip and the non-glare matte black finish won't give you away
- **TWO INTERCHANGEABLE COMB PIECES** allow you to fine-tune drop at comb for use with iron, electronic or optical sights
- **TWO INTERCHANGEABLE LENGTH OF PULL SPACERS** allow you to fine-tune length of pull for a perfect stock fit
- **TACTICAL RIBBED FOREARM** for better control when you need it most
- **HARD CHROME-PLATED CHAMBER AND BORE** make these surfaces highly resistant to wear and corrosion

- **INVECTOR-PLUS™ CYLINDER CHOKE TUBE** handles both slugs and buckshot
- **3" CHAMBER** gives you the ability to reach out for challenging shots
- **BLACK CHROME PROTECTION** on the bolt and other components lasts longer than traditional bluing
- **REMOVABLE TRUGLO® FIBER-OPTIC FRONT SIGHT** plus a traditional brass front bead offer a fast, natural sight picture
- **DRILLED AND TAPPED ALLOY RECEIVER** is ready for optics mounting
- **ROTARY BOLT** with four massive lugs provides strength, support and solid lockup
- **CROSSBOLT SAFETY** is easily operated, even with gloves
- **INFLEX TECHNOLOGY RECOIL PAD** directs felt recoil down and away from your cheek to reduce flinch and fatigue



Two user-interchangeable combs and height adjust spacers let you tune comb height on your Super X® Pump Shadow Defender™ and Shadow Marine Defender™ for perfect eye-to-sight alignment with your choice of sighting systems.



SUPER X® PUMP

# SMART HOME SECURITY.

A WINCHESTER® SUPER X® PUMP DEFENDER IS THE SMART CHOICE FOR HOME SECURITY.



**STOP THE THREAT™**  
The 12-gauge PDX1 Defender ammunition features a distinctive black hull, black oxide high-base head and 3 pellets of Grex-buffered DD plated buckshot nested on top of a 1 oz. rifled slug. The result is the ideal, tight patterning personal defense load. The slug/buckshot combination provides optimum performance at short and long ranges while compensating for aim error.





The receivers on both the Winchester® Super X® Pump Defender™ and Marine Defender™ shotgun models are drilled and tapped for Winchester scope bases and rings. See the full line of bases and rings on page 77.



# DEFENDER™

- **SYNTHETIC STOCK WITH TEXTURED GRIPPING SURFACES** gives your hands a sure, non-slip grip and the non-glare matte black finish won't reveal your position
- **TACTICAL RIBBED FOREARM** for better control when you need it most
- **HARD CHROME-PLATED CHAMBER AND BORE** make these surfaces highly resistant to wear and corrosion
- **FIXED-CYLINDER CHOKED BARREL** handles both slugs and buckshot
- **DRILLED AND TAPPED ALLOY RECEIVER** is ready for optics mounting

- **TRADITIONAL BRASS BEAD FRONT SIGHT** offers a fast, natural sight picture
- **ROTARY BOLT** with four massive lugs provides strength and solid lockup
- **DROP-OUT TRIGGER GROUP** allows for easy cleaning
- **CROSSBOLT SAFETY** is easily operated, even with gloves
- **BLACK CHROME PROTECTION** on the bolt and other components lasts longer than traditional bluing
- **INFLEX TECHNOLOGY RECOIL PAD** directs felt recoil down and away from your cheek to reduce flinch and fatigue



# MARINE DEFENDER™

- **MATTE HARD CHROME PLATING** on barrel, magazine tube, slide arms and other components for the ultimate protection against wear and the elements
- **SYNTHETIC STOCK WITH TEXTURED GRIPPING SURFACES** gives your hands a sure, non-slip grip and the non-glare matte black finish won't give you away
- **TACTICAL RIBBED FOREARM** for better control when you need it most
- **HARD CHROME-PLATED CHAMBER AND BORE** make these surfaces highly resistant to wear and corrosion
- **DRILLED AND TAPPED ALLOY RECEIVER** is ready for optics mounting

- **REMOVABLE TRUGLO® FIBER-OPTIC FRONT SIGHT** plus a traditional brass front bead offer a fast, natural sight picture
- **INVECTOR-PLUS™ CHOKE TUBE SYSTEM** with cylinder choke installed, works with slugs or buckshot
- **ROTARY BOLT** with four massive lugs provides strength and solid lockup
- **DROP-OUT TRIGGER GROUP** allows for easy cleaning
- **CROSSBOLT SAFETY** is easily operated, even with gloves
- **INFLEX TECHNOLOGY RECOIL PAD** directs felt recoil down and away from your cheek to reduce flinch and fatigue



ITEM NUMBER	GAUGE	BARREL LENGTH	CHAMBER	MAG CAP	CHOKE TUBES INCLUDED	OVERALL LENGTH	LENGTH OF PULL	DROP AT COMB	DROP AT HEEL	NOMINAL WT. (LBS)	SUGGESTED RETAIL
<b>SXP DEFENDER</b>											
512252395	12	18"	3"	5*	N/A	38 1/2"	13 3/4"	13/8"	15/8"	6 1/4	\$349.99
512252695	20	18"	3"	5*	N/A	38 1/2"	13 3/4"	13/8"	15/8"	6	379.99
<b>SXP MARINE DEFENDER</b>											
512268395	12	18"	3"	5*	CYL	38 1/2"	13 3/4"	13/8"	15/8"	6 1/4	\$399.99
512268695	20	18"	3"	5*	CYL	38 1/2"	13 3/4"	13/8"	15/8"	6	429.99

\*TOTAL AMMUNITION CAPACITY INCLUDES ONE ADDITIONAL SHELL IN THE CHAMBER.



# TOOLS FOR TOMS.

A TRICKED-OUT TRIO OF TROPHY TOM TAKERS.



## TURKEY HUNTER



Two user-interchangeable combs and height adjustment spacers let you tune comb height on your Super X® Pump Long Beard™ for perfect eye-to-sight alignment with your choice of sighting systems.



### LONG BEARD™ CHOKE TUBE

Aggressively avid turkey hunters will go to great lengths to tag that trophy tom. The Winchester® Super X® Pump Long Beard™ model features an extended Extra-Full Turkey tube with a fluted body, knurled friction ring and camo front band. It's designed to extract every bit of potential from Winchester Long Beard® XR® turkey ammunition.

ITEM NUMBER	GAUGE	BARREL LENGTH	CHAMBER	MAG CAP	CHOKE TUBES INCLUDED	OVERALL LENGTH**	LENGTH OF PULL	DROP AT COMB	DROP AT HEEL	NOMINAL WT. (LBS)	SUGGESTED RETAIL
<b>SXP TURKEY</b>											
512341290	12	24"	3 1/2"	4*	T	45"	13 3/4"	1 5/8"	2"	6 5/8	\$439.99
512341690	20	24"	3"	5*	T	44 1/2"	13 3/4"	1 5/8"	2"	6 1/4	439.99
<b>SXP TURKEY HUNTER [MOSSY OAK BREAK-UP COUNTRY]</b>											
512307290	12	24"	3 1/2"	4*	T	45"	13 3/4"	1 5/8"	2"	6 5/8	\$519.99
512307690	20	24"	3"	5*	T	44 1/2"	13 3/4"	1 5/8"	2"	6 1/4	519.99
<b>SXP TURKEY HUNTER [MOSSY OAK OBSESSION]</b>											
512357290	12	24"	3 1/2"	4*	T	45"	13 3/4"	1 5/8"	2"	6 5/8	\$519.99
512357690	20	24"	3"	5*	T	44 1/2"	13 3/4"	1 5/8"	2"	6 1/4	519.99

\*TOTAL AMMUNITION CAPACITY INCLUDES ONE ADDITIONAL SHELL IN THE CHAMBER. \*\*OVERALL LENGTH DOES NOT INCLUDE CHOKE TUBE.



# TURKEY



- **SYNTHETIC STOCK WITH TEXTURED GRIPPING SURFACES** gives your hands a sure, non-slip grip and is available in your choice of either Mossy Oak® Break-Up Country® or Obsession® camo or a non-glare matte black finish that won't scare off skittish birds
- **BACK-BORED TECHNOLOGY** provides optimum shot patterns that are dense and even
- **A 3" CHAMBER IN 20 GAUGE, OR A 3 1/2" CHAMBER IN 12 GAUGE** gives you the power to reach out for those long-range turkeys
- **INVECTOR-PLUS™ EXTRA-FULL TURKEY CHOKE TUBE** for a tight, dense pattern
- **HARD CHROME-PLATED CHAMBER AND BORE** make these surfaces highly resistant to wear and corrosion

- **DRILLED AND TAPPED ALLOY RECEIVER** is ready for optics mounting
- **TRUGLO® FIBER-OPTIC ADJUSTABLE SIGHTS** offer a fast, natural sight picture
- **ROTARY BOLT** with four massive lugs provides strength and solid lockup
- **DROP-OUT TRIGGER GROUP** allows for easy cleaning
- **CROSSBOLT SAFETY** is easily operated, even with gloves
- **BLACK CHROME PROTECTION** on the bolt and other components lasts longer than traditional bluing
- **INFLEX TECHNOLOGY RECOIL PAD** directs felt recoil down and away from your cheek to reduce flinch and fatigue



# LONG BEARD™



- **SYNTHETIC PISTOL GRIP STOCK WITH TEXTURED GRIPPING SURFACES** gives your hands a sure, non-slip grip and the Mossy Oak® Break-Up Country® camo finish won't spook wary birds
- **TWO INTERCHANGEABLE COMB PIECES** allow you to fine-tune drop at comb for use with iron, electronic or optical sights
- **TWO INTERCHANGEABLE LENGTH OF PULL SPACERS** allow you to fine-tune length of pull for a perfect stock fit
- **BACK-BORED TECHNOLOGY** provides optimum shot patterns that are dense and even
- **CHOICE OF 3" OR 3 1/2" CHAMBER** gives you the power to reach out for those long-range turkeys
- **INVECTOR-PLUS™ EXTRA-FULL LONG BEARD™ TURKEY CHOKE TUBE** for a tight, dense pattern, especially with Winchester® Long Beard® XR® ammunition

- **HARD CHROME-PLATED CHAMBER AND BORE** make these surfaces highly resistant to wear and corrosion
- **DRILLED AND TAPPED ALLOY RECEIVER** is ready for optics mounting
- **TRUGLO® FIBER-OPTIC ADJUSTABLE SIGHTS** offer a fast, natural sight picture
- **ROTARY BOLT** with four massive lugs provides strength and solid lockup
- **DROP-OUT TRIGGER GROUP** allows for easy cleaning
- **CROSSBOLT SAFETY** is easily operated, even with gloves
- **BLACK CHROME PROTECTION** on the bolt and other components lasts longer than traditional bluing
- **INFLEX TECHNOLOGY RECOIL PAD** directs felt recoil down and away from your cheek to reduce flinch and fatigue

ITEM NUMBER	GAUGE	BARREL LENGTH	CHAMBER	MAG CAP	CHOKE TUBES INCLUDED	OVERALL LENGTH**	LENGTH OF PULL	DROP AT COMB	DROP AT HEEL	NOMINAL WT. (LBS)	SUGGESTED RETAIL
<b>SXP LONG BEARD (MOSSY OAK BREAK-UP COUNTRY)</b>											
512320290	12	24"	3 1/2"	4*	Long Beard	44 1/2"	13 3/4"	13/4"	2"	7 1/4	\$559.99
512320390	12	24"	3"	4*	Long Beard	44"	13 3/4"	13/4"	2"	7 1/4	529.99
512320690	20	24"	3"	5*	Long Beard	44"	13 3/4"	13/4"	2"	7 1/4	559.99
<b>SXP LONG BEARD (MOSSY OAK OBSESSION)</b>											
512352290	12	24"	3 1/2"	4*	Long Beard	44 1/2"	13 3/4"	13/4"	2"	7 1/4	\$559.99
512352390	12	24"	3"	4*	Long Beard	44"	13 3/4"	13/4"	2"	7 1/4	529.99
512352690	20	24"	3"	5*	Long Beard	44"	13 3/4"	13/4"	2"	7 1/4	559.99

\*TOTAL AMMUNITION CAPACITY INCLUDES ONE ADDITIONAL SHELL IN THE CHAMBER. \*\*OVERALL LENGTH DOES NOT INCLUDE CHOKE TUBE.



# MODEL 101™

**THE SHEER ELEGANCE OF THE MODEL 101 MAKES OWNING A CLASSIC WINCHESTER® OVER AND UNDER SHOTGUN LIKE NOTHING ELSE ON EARTH.**

The exceptional quality and lasting performance, along with the exquisite look and feel of a fine Belgian-made over and under is something few ever get to experience firsthand. Now there is a perfect European stackbarrel at a price that fits into almost any shooter's budget. Today's Model 101™ is built along the classic lines of the legendary original using the latest manufacturing processes and materials. It offers legendary Winchester® quality in an over and under that exacting shooters demand.



Today's Model 101™ features the same **FAMILIAR DIMENSIONS** set long ago by the original. The familiar drop at comb and narrow grip ensure time-tested comfort and performance.



The Model 101™ has the drop on the original with the advantage of a **LOW-PROFILE RECEIVER**. This means that recoil occurs in-line, directly back for faster follow-up shots with less muzzle jump. Also, your forward hand is placed closer to the bore centerline, bringing your hands, face and sighting plane into a more natural alignment for intuitive and accurate shooting.



An **ADJUSTABLE COMB** stock allows you to modify individual height and cast on/off for a custom fit in just seconds. (Hex wrench is included.)

Every Model 101™ shotgun has **FINELY CUT CHECKERING** to improve grip and add artistic elegance to the well-figured walnut stock and forearm.



Getting pounded by recoil is now a thing of the past with the patented **PACHMAYR® DECELERATOR® RECOIL PAD** found on all Model 101™ shotguns. The Pachmayr pad on the Sporting model has a snag-free heel for fast and easy shouldering.



An **ADJUSTABLE TRIGGER SHOE** lets you fine tune its fore and aft position to your precise length of pull for more comfortable shooting on Pigeon and Sporting models. (Hex wrench is included.)



Sporting and Field models have a fitted **STEEL GRIP CAP** to add a touch of graceful elegance.



**BACK-BORED TECHNOLOGY**

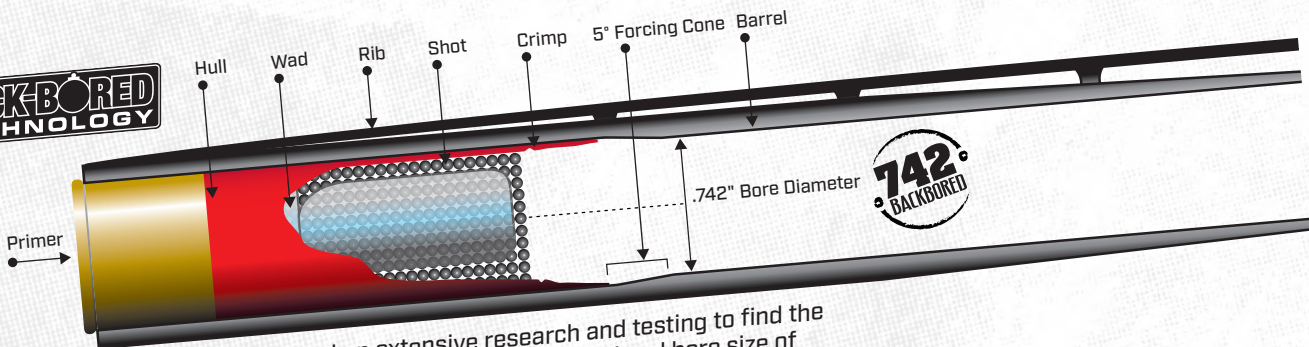

**BACK-BORED TECHNOLOGY** is based on extensive research and testing to find the secret to tighter, more consistent patterns. Instead of the traditional bore size of .729", this research shows the ideal 12 gauge interior diameter is .742". If the bore is any larger the gases will blow by the shot cup and reduce pellet velocity. If the bore is too tight the pellets are deformed as they pass through the forcing cone, causing poor ballistic performance.

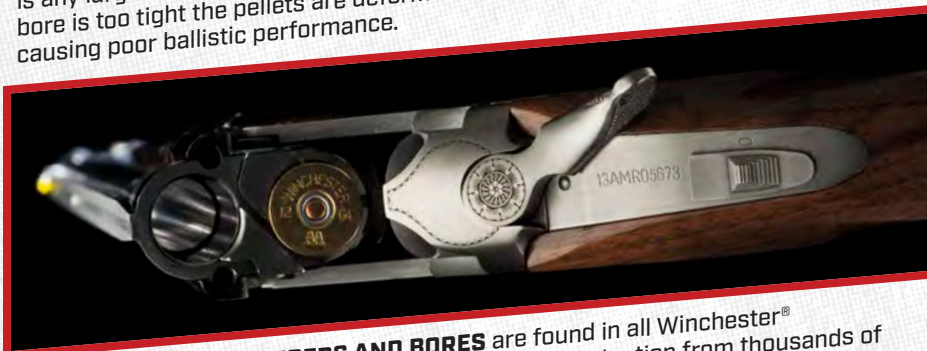

**CHROME-PLATED CHAMBERS AND BORES** are found in all Winchester® Model 101™ shotguns. This critical plating provides protection from thousands of heavy, high density, abrasive loads. This extra feature virtually eliminates wear and tear caused by thousands of shells.



**TOUGH STEEL HINGE** areas bear tension from recoil with each shot, so the Model 101™ shotgun is built with surfaces that are 49% larger than many competitors. The surfaces are machined simultaneously with the hinge, ensuring perfect alignment.



The Model 101™ shotgun's **LOCKING LUGS** have 30% more contact surface than the competition for an action that's the strongest in the industry and built to last.



From the field to the range, the **INVECTOR-PLUS™ CHOKE TUBE SYSTEM** is the world's most consistent. All Model 101™ shotguns come with either extended Signature or flush-mounted Invector-Plus tubes, depending on the model.



**TRUGLO®**

Model 101™ Pigeon Trap and Sporting models feature **TRUGLO® FIBER-OPTIC FRONT SIGHTS** for faster target acquisition.

# CLAY CRUSHERS.

POWDER EVERY CLAY TARGET THAT COMES YOUR WAY.



Model 101™ Pigeon Trap adjustable comb.



## SPORTING



**BACK-BORED TECHNOLOGY** TRUGLO

- **HIGH GLOSS GRADE II/III WALNUT STOCK WITH 20 LINES-PER-INCH CUT CHECKERING** looks elegant and improves grip
- **TRADITIONAL MODEL 101™ SHOTGUN DIMENSIONS** give you a performance advantage plus classic styling
- **LOW-PROFILE RECEIVER** gives you faster target acquisition, a more controlled swing and less felt recoil
- **TRUGLO® TRU-BEAD® INTERCHANGEABLE FIBER-OPTIC FRONT SIGHT** offers a fast, natural sight picture
- **BACK-BORED TECHNOLOGY** provides optimum shot patterns that are dense and even
- **STEEL GRIP CAP** adds a touch of classic elegance

- **EXTENDED SIGNATURE INVECTOR-PLUS™ CHOKE TUBES** offer predictable patterns to match your situation
- **ADJUSTABLE TRIGGER SHOE** for perfect length of pull
- **HARD CHROME-PLATED CHAMBERS AND BORES** make these surfaces highly resistant against wear and corrosion
- **49% MORE HINGE SURFACE AREA** than our competitors, giving you greater strength for long-term durability
- **30% MORE LOCKING LUG CONTACT AREA** keeps the action tighter and minimizes wear
- **PACHMAYR® DECELERATOR® RECOIL PAD** absorbs felt recoil to reduce flinch and fatigue



Every Model 101™ Sporting and Pigeon Trap shotgun comes with a durable, fitted ABS hard case imprinted with the Winchester Repeating Arms® logo.

# PIGEON TRAP



**BACK-BORED TECHNOLOGY**

**TRUGLO**

- **HIGH GLOSS GRADE II/III WALNUT STOCK WITH 20 LINES-PER-INCH CUT CHECKERING** looks elegant and improves grip
- **ADJUSTABLE COMB OPTION** lets you custom fit the stock to your shooting style
- **LOW-PROFILE NICKEL-PLATED RECEIVER WITH CLASSIC PIGEON ENGRAVING** gives you faster target acquisition, a more controlled swing and less felt recoil
- **TRUGLO® TRU-BEAD® INTERCHANGEABLE FIBER-OPTIC FRONT SIGHT** offers a true, precise sight picture
- **TRADITIONAL MODEL 101™ SHOTGUN DIMENSIONS** give you a performance advantage plus classic styling

- **EXTENDED SIGNATURE INVECTOR-PLUS™ CHOKE TUBES** offer predictable patterns to match your situation
- **BACK-BORED BARRELS** provide optimum shot patterns that are dense and even
- **PORTED BARRELS** reduce muzzle jump and help tame felt recoil
- **ADJUSTABLE TRIGGER** for perfect length of pull
- **HARD CHROME-PLATED CHAMBERS AND BORES** make these surfaces highly resistant to wear and corrosion
- **WHITE LINE SPACER PACHMAYR® DECELERATOR® RECOIL PAD** provides optimal protection against felt recoil

ITEM NUMBER	GAUGE	BARREL LENGTH	CHAMBER	CHOKE TUBES INCLUDED	OVERALL LENGTH**	LENGTH OF PULL	DROP AT COMB	DROP AT HEEL	NOMINAL WT. (LBS)	SUGGESTED RETAIL
<b>MODEL 101 PIGEON TRAP</b>										
513057493	12	30"	2 3/4"	XF, F, IM	47 5/8"	14 5/8"	11/2"	2 3/8"	7 1/2	\$2,519.99
513057494	12	32"	2 3/4"	XF, F, IM	49 5/8"	14 5/8"	11/2"	2 3/8"	7 5/8	2,519.99
<b>MODEL 101 PIGEON TRAP (ADJUSTABLE COMB)</b>										
513059493	12	30"	2 3/4"	XF, F, IM	47 5/8"	14 5/8"	11/2"*	2 3/8"*	7 1/2	\$2,679.99
513059494	12	32"	2 3/4"	XF, F, IM	49 5/8"	14 5/8"	11/2"*	2 3/8"*	7 5/8	2,679.99
<b>MODEL 101 SPORTING</b>										
513054492	12	28"	2 3/4"	LF, IM, M, IC, SK	45 5/8"	14 5/8"	13/8"	2 3/8"	7 1/8	\$2,379.99
513054493	12	30"	2 3/4"	LF, IM, M, IC, SK	47 5/8"	14 5/8"	13/8"	2 3/8"	7 1/4	2,379.99
513054494	12	32"	2 3/4"	LF, IM, M, IC, SK	49 5/8"	14 5/8"	13/8"	2 3/8"	7 3/8	2,379.99

\*ADJUSTABLE COMB STOCK DIMENSIONS ARE MEASURED WITH COMB IN THE LOWEST POSITION.  
 \*\*DOES NOT INCLUDE ADDED LENGTH OF CHOKE TUBES.



**MODEL 101™**

MODEL 101™

# UPLAND UPSCALE.

THIS CLASSIC WINCHESTER® DOUBLE WILL MAKE EVERY SHOOTER'S  
UPLAND DREAMS A REALITY.



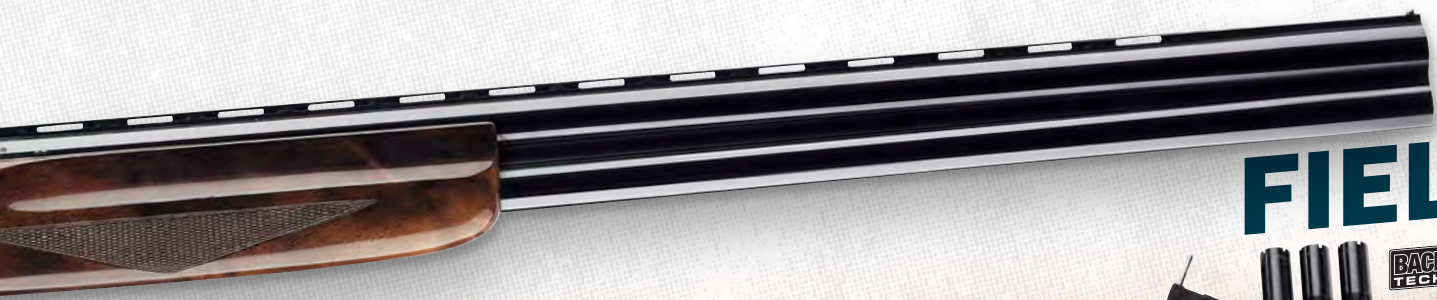

# FIELD



**BACK-BORED TECHNOLOGY**

- **HIGH GLOSS GRADE II/III WALNUT STOCK WITH 20 LINES-PER-INCH CUT CHECKERING** looks elegant and improves grip
- **LOW-PROFILE RECEIVER** gives you faster target acquisition, a more controlled swing and less felt recoil
- **STEEL GRIP CAP** adds a classic touch
- **BACK-BORED BARRELS** provide optimum shot patterns that are dense and even
- **HARD CHROME-PLATED CHAMBERS AND BORES** make these surfaces highly resistant against wear and corrosion

- **INVECTOR-PLUS™ CHOKE TUBES** offer predictable patterns to match your situation
- **49% MORE HINGE SURFACE AREA** than our competitors, giving you greater strength for long-term durability
- **30% MORE LOCKING LUG CONTACT AREA** keeps the action tighter and minimizes wear
- **WHITE LINE SPACER PACHMAYR® DECELERATOR® RECOIL PAD** provides optimal protection against felt recoil

ITEM NUMBER	GAUGE	BARREL LENGTH	CHAMBER	CHOKE TUBES INCLUDED	OVERALL LENGTH	LENGTH OF PULL	DROP AT COMB	DROP AT HEEL	NOMINAL WT. (LBS)	SUGGESTED RETAIL
<b>MODEL 101 FIELD</b>										
513046371	12	26"	3"	F, M, IC	43 1/4"	14 1/4"	1 3/8"	2 3/8"	6 3/4	\$1,899.99
513046361	12	28"	3"	F, M, IC	45 1/4"	14 1/4"	1 3/8"	2 3/8"	7	1,899.99

# MODEL 101™

**WINCHESTER® CHOKE TUBES**  
 Winchester® Signature choke tubes are unsurpassed in the shotgun industry. In collaboration with Briley®, one of the most renowned makers of choke tubes in the world, the Invector-Plus™ and Standard Invector™ tubes are carefully machined from the best materials and calibrated to the strictest tolerances to deliver shot patterns exceeding your highest expectations. Installing these tubes in our barrels ensure that the shooter is getting optimum patterning for the most challenging wild game and the most difficult presentations in clay target shooting.

ITEM NUMBER	GA.	DESCRIPTION	DIAMETER	CONstriction	SUGGESTED RETAIL
<b>INVECTOR-PLUS CHOKE TUBES</b>					
12 GAUGE FOR WINCHESTER SUPREME, SELECT, SUPER X2, SUPER X3, SUPER X4, SUPER X PUMP AND MODEL 101 SHOTGUNS.					
613050	12	Extra-Full	.700	.040	\$34.99
613051	12	Full	.705	.035	34.99
613052	12	Improved Modified	.715	.025	34.99
613053	12	Modified	.720	.020	34.99
613054	12	Improved Cylinder	.730	.010	34.99
613055	12	Skeet	.735	.005	34.99
613056	12	Cylinder	.740	.000	34.99

ITEM NUMBER	GA.	DESCRIPTION	DIAMETER	CONstriction	SUGGESTED RETAIL
<b>STANDARD INVECTOR CHOKE TUBES</b>					
12 GAUGE FOR WINCHESTER SUPER X2 PRACTICAL MODELS.					
6130303	12	Full	.690	.035	\$29.99
6130313	12	Improved Modified	.700	.025	29.99
6130323	12	Modified	.705	.020	29.99
6130333	12	Improved Cylinder	.715	.010	29.99
6130343	12	Skeet	.720	.005	29.99
6130353	12	Cylinder	.725	.000	29.99

ITEM NUMBER	GA.	DESCRIPTION	DIAMETER	CONstriction	SUGGESTED RETAIL
<b>SIGNATURE INVECTOR-PLUS CHOKE TUBES</b>					
12 GAUGE FOR WINCHESTER SUPREME, SELECT, SUPER X2, SUPER X3, SUPER X4, SUPER X PUMP AND MODEL 101 SHOTGUNS.					
61307103	12	Turkey (Camo Band)	.660	.082	\$49.99
6130703	12	Extra-Full Trap	.700	.040	49.99
6130713	12	Full	.705	.035	49.99
6130723	12	Light Full	.710	.030	49.99
6130733	12	Improved Modified	.715	.025	49.99
6130743	12	Modified	.720	.020	49.99
6130753	12	Light Modified	.725	.015	49.99
6130763	12	Improved Cylinder	.730	.010	49.99
6130773	12	Skeet	.735	.005	49.99
6130783	12	Cylinder	.740	.000	49.99
6130793	12	Spreader/Diffuser	Rifled	-	74.99

ITEM NUMBER	GA.	DESCRIPTION	DIAMETER	CONstriction	SUGGESTED RETAIL
<b>LONG BEARD INVECTOR-PLUS CHOKE TUBE</b>					
12 GAUGE FOR WINCHESTER SUPREME, SELECT, SUPER X2, SUPER X3, SUPER X4, SUPER X PUMP AND MODEL 101 SHOTGUNS.					
61305106	12	Long Beard	.665	.077	\$69.99

ITEM NUMBER	DESCRIPTION	SUGGESTED RETAIL
<b>SUPER X RIFLE HINGED FLOORPLATE MAGAZINE</b>		
112029907	30-06 Sprg	\$79.99
112029906	300 Win Mag	79.99
112029904	270 WSM	79.99
112029905	300 WSM	79.99
<b>SUPER X RIFLE DETACHABLE FLOORPLATE MAGAZINE</b>		
112029903	30-06 Sprg	\$79.99
112029902	300 Win Mag	79.99
112029900	270 WSM	79.99
112029901	300 WSM	79.99
<b>XPR RIFLE DETACHABLE BOX MAGAZINE</b>		
112098800	Long Standard: 270 Win, 30-06 Sprg	\$29.99
112098801	Long Magnum: 7mm Rem Mag, 300 Win Mag, 338 Win Mag	29.99
112098802	Short Standard: 243 Win, 6.5 Creedmoor, 7mm-08 Rem, 308 Win	29.99
112098803	Short Magnum: 270 WSM, 300 WSM, 325 WSM	29.99
<b>WILDCAT RIFLE MAGAZINE</b>		
112028022	22 Long Rifle	\$16.99

(AMMUNITION SHOWN NOT INCLUDED.)



**SUPER X® RIFLE HINGED FLOORPLATE MAGAZINE**



**SUPER X® RIFLE DETACHABLE FLOORPLATE MAGAZINE**



**XPR® RIFLE DETACHABLE BOX MAGAZINE**



**WILDCAT™ RIFLE MAGAZINE**

## WINCHESTER® SCOPE BASES AND RINGS

Your favorite Winchester® firearm should carry its scope in genuine Winchester bases and rings. Designed and manufactured with absolute precision from 7000-series aircraft grade aluminum alloy or solid steel (where noted) these mounts will reliably hold today's high-magnification optics without shifting zero.



**XPR® AND MODEL 70® RIFLE SCOPE SET WITH INTEGRATED BASES** simplify mounting and help ensure the scope will stay zeroed in adverse conditions.



**BASES AND RINGS** are available in **GLOSS FINISH** to match both scope and firearm.



**WINCHESTER® BASES** for XPR® RIFLES and SHOTGUNS accept Weaver®-style rings.

**BASES** for 1885 RIFLES accept Winchester® rings.



**SUPER X® PUMP BASE**

ITEM NUMBER	DESCRIPTION	SUGGESTED RETAIL
<b>SCOPE BASES AND RINGS</b>		
62100	Scope Set, M70, Low Height, Matte, 1"	\$69.99
62200	Scope Set, M70, Med Height, Matte, 1"	69.99
62300	Scope Set, M70, High Height, Matte, 1"	69.99
62101	Scope Set, M70, Low Height, Matte, 30mm	69.99
62201	Scope Set, M70, Med Height, Matte, 30mm	69.99
62301	Scope Set, M70, High Height, Matte, 30mm	69.99
62102	Scope Set, M70 Safari, Low Height, Matte, 1"	69.99
62202	Scope Set, M70 Safari, Med Height, Matte, 1"	69.99
62302	Scope Set, M70 Safari, High Height, Matte, 1"	69.99
62103	Scope Set, M70 Safari, Low Height, Matte, 30mm	69.99
62203	Scope Set, M70 Safari, Med Height, Matte, 30mm	69.99
62303	Scope Set, M70 Safari, High Height, Matte, 30mm	69.99
63100	Scope Set, M70, Low Height, Gloss, 1"	69.99
63200	Scope Set, M70, Med Height, Gloss, 1"	69.99
63300	Scope Set, M70, High Height, Gloss, 1"	69.99
63101	Scope Set, M70, Low Height, Gloss, 30mm	69.99
63201	Scope Set, M70, Med Height, Gloss, 30mm	69.99
63301	Scope Set, M70, High Height, Gloss, 30mm	69.99
63102	Scope Set, M70 Safari, Low Height, Gloss, 1"	69.99
63202	Scope Set, M70 Safari, Med Height, Gloss, 1"	69.99
63302	Scope Set, M70 Safari, High Height, Gloss, 1"	69.99
63103	Scope Set, M70 Safari, Low Height, Gloss, 30mm	69.99
63203	Scope Set, M70 Safari, Med Height, Gloss, 30mm	69.99
63303	Scope Set, M70 Safari, High Height, Gloss, 30mm	69.99
62620	Scope Set, XPR, Low Height, Matte, 1"	69.99
62621	Scope Set, XPR, Med Height, Matte, 1"	69.99
62622	Scope Set, XPR, High Height, Matte, 1"	69.99
64630	Scope Set, XPR, Low Height, Matte, 30mm	69.99
64631	Scope Set, XPR, Med Height, Matte, 30mm	69.99
64632	Scope Set, XPR, High Height, Matte, 30mm	44.99
63500	Steel Base, M70, Gloss	104.99
63501	Steel Base, M1885 High Wall Hunter, Gloss	104.99
63502	Steel Base, M1885 Low Wall, Gloss	99.99
63600	Steel Rings, Low Height, Gloss, 1"	99.99
63601	Steel Rings, Med Height, Gloss, 1"	99.99
63602	Steel Rings, High Height, Gloss, 1"	99.99
63603	Steel Rings, Low Height, Gloss, 30mm	99.99
63604	Steel Rings, Med Height, Gloss, 30mm	99.99
63605	Steel Rings, High Height, Gloss, 30mm	29.99
62500	Alloy Base, SXP, Matte	29.99
62501	Alloy Base, SX4/SX3/SX2, Matte	24.99
62502	Weaver-style Alloy Base, XPR, 2-Piece, Matte	34.99
62600	Weaver-style Alloy Rings, Low Height, Matte, 1"	34.99
62601	Weaver-style Alloy Rings, Med Height, Matte, 1"	34.99
62602	Weaver-style Alloy Rings, High Height, Matte, 1"	34.99
62610	Weaver-style Alloy Rings, Low Height, Matte, 30mm	34.99
62611	Weaver-style Alloy Rings, Med Height, Matte, 30mm	34.99
62612	Weaver-style Alloy Rings, High Height, Matte, 30mm	34.99

# EXTRA BARRELS

## DESCRIPTION

## SUGGESTED RETAIL

ITEM NUMBER	GA.	CHAMBER	BARREL LENGTH	DESCRIPTION	SUGGESTED RETAIL
<b>SUPER X PUMP RIFLED BARRELS</b>					
611261240	12	3.5"	22"	Matte Blued, Rifled, TruGlo Sights	\$179.99
611261340	12	3"	22"	Matte Blued, Rifled, TruGlo Sights	179.99
611261640	20	3"	22"	Matte Blued, Rifled, TruGlo Sights	179.99
<b>SUPER X PUMP FIELD AND TURKEY BARRELS</b>					
611251290	12	3.5"	24"	Matte Blued, Vent Rib, w/ One Modified Invector-Plus Choke Tube	\$149.99
611251291	12	3.5"	26"	Matte Blued, Vent Rib, w/ One Modified Invector-Plus Choke Tube	149.99
611251292	12	3.5"	28"	Matte Blued, Vent Rib, w/ One Modified Invector-Plus Choke Tube	149.99
611251390	12	3"	24"	Matte Blued, Vent Rib, w/ One Modified Invector-Plus Choke Tube	149.99
611251391	12	3"	26"	Matte Blued, Vent Rib, w/ One Modified Invector-Plus Choke Tube	149.99
611251392	12	3"	28"	Matte Blued, Vent Rib, w/ One Modified Invector-Plus Choke Tube	149.99
611251690	20	3"	24"	Matte Blued, Vent Rib, w/ One Modified Invector-Plus Choke Tube	189.99
611251691	20	3"	26"	Matte Blued, Vent Rib, w/ One Modified Invector-Plus Choke Tube	189.99
611251692	20	3"	28"	Matte Blued, Vent Rib, w/ One Modified Invector-Plus Choke Tube	189.99
611321291	12	3.5"	26"	MOBUC, Vent Rib, w/ One Modified Invector-Plus Choke Tube	189.99
611321292	12	3.5"	28"	MOBUC, Vent Rib, w/ One Modified Invector-Plus Choke Tube	189.99
611270291	12	3.5"	26"	MOSGB, Vent Rib, w/ One Modified Invector-Plus Choke Tube	189.99
611270292	12	3.5"	28"	MOSGB, Vent Rib, w/ One Modified Invector-Plus Choke Tube	189.99
611254291	12	3.5"	26"	MODB, Vent Rib, w/ One Modified Invector-Plus Choke Tube	189.99
611254292	12	3.5"	28"	MODB, Vent Rib, w/ One Modified Invector-Plus Choke Tube	189.99
611293291	12	3.5"	26"	MOBL, Vent Rib, w/ One Modified Invector-Plus Choke Tube	189.99
611293292	12	3.5"	28"	MOBL, Vent Rib, w/ One Modified Invector-Plus Choke Tube	189.99
611290291	12	3.5"	26"	MAX-5, Vent Rib, w/ One Modified Invector-Plus Choke Tube	189.99
611290292	12	3.5"	28"	MAX-5, Vent Rib, w/ One Modified Invector-Plus Choke Tube	189.99
611290391	12	3"	26"	MAX-5, Vent Rib, w/ One Modified Invector-Plus Choke Tube	189.99
611290392	12	3"	28"	MAX-5, Vent Rib, w/ One Modified Invector-Plus Choke Tube	189.99
611254391	12	3"	26"	MODB, Vent Rib, w/ One Modified Invector-Plus Choke Tube	149.99
611254392	12	3"	28"	MODB, Vent Rib, w/ One Modified Invector-Plus Choke Tube	149.99
611251253	12	3.5"	24"	Matte Blued, Vent Rib, w/ One X-Full Invector-Plus Choke Tube	139.99
611251353	12	3"	24"	Matte Blued, Vent Rib, w/ One X-Full Invector-Plus Choke Tube	139.99
611257391	12	3"	26"	Matte Blued, Vent Rib 5-Shot, w/ One X-Full Invector-Plus Choke Tube	149.99
611257392	12	3"	28"	Matte Blued, Vent Rib 5-Shot, w/ One X-Full Invector-Plus Choke Tube	149.99
611251653	20	3"	24"	Matte Blued, Vent Rib, w/ One X-Full Invector-Plus Choke Tube	\$579.99
<b>SUPER X3 RIFLED BARRELS</b>					
611108240	12	3.5"	22"	Matte Blued, Rifled, Cantilever Scope Mount w/ Synthetic Forearm*	\$579.99
611108340	12	3"	22"	Matte Blued, Rifled, Cantilever Scope Mount w/ Synthetic Forearm*	599.99
611107340	12	3"	22"	MOBUC, Rifled, Cantilever Scope Mount w/ Synthetic Forearm*	579.99
611062640	20	3"	22"	Matte Blued, Rifled, Cantilever Scope Mount w/ Synthetic Forearm	
<b>SUPER X3 FIELD AND TURKEY BARRELS</b>					
611053271	12	3.5"	26"	Perma-Cote UT Gray, Vent Rib, w/ One Modified Invector-Plus Choke Tube	\$419.99
611053261	12	3.5"	28"	Perma-Cote UT Gray, Vent Rib, w/ One Modified Invector-Plus Choke Tube	419.99
611054371	12	3"	26"	Perma-Cote UT Gray, Vent Rib, w/ One Modified Invector-Plus Choke Tube	419.99
611054361	12	3"	28"	Perma-Cote UT Gray, Vent Rib, w/ One Modified Invector-Plus Choke Tube	419.99
611054691	12	3"	26"	Perma-Cote UT Gray, Vent Rib, w/ One Modified Invector-Plus Choke Tube	399.99
611054692	12	3"	28"	Perma-Cote UT Gray, Vent Rib, w/ One Modified Invector-Plus Choke Tube	399.99
611123291	20	3"	26"	Matte Blued, Vent Rib, w/ One Modified Invector-Plus Choke Tube	399.99
611123292	12	3.5"	28"	Matte Blued, Vent Rib, w/ One Modified Invector-Plus Choke Tube	399.99
611123390	12	3"	24"	Matte Blued, Vent Rib, w/ One Modified Invector-Plus Choke Tube	399.99
611123391	12	3"	26"	Matte Blued, Vent Rib, w/ One Modified Invector-Plus Choke Tube	399.99
611123392	12	3"	28"	Matte Blued, Vent Rib, w/ One Modified Invector-Plus Choke Tube	399.99
611123690	20	3"	24"	Matte Blued, Vent Rib, w/ One Modified Invector-Plus Choke Tube	399.99
611123691	20	3"	26"	Matte Blued, Vent Rib, w/ One Modified Invector-Plus Choke Tube	499.99
611123692	20	3"	28"	Matte Blued, Vent Rib, w/ One Modified Invector-Plus Choke Tube	499.99
611155291	12	3.5"	26"	MOSGB, Vent Rib, w/ One Modified Invector-Plus Choke Tube	499.99
611155292	12	3.5"	28"	MOSGB, Vent Rib, w/ One Modified Invector-Plus Choke Tube	499.99
611158291	12	3.5"	26"	MOBL, Vent Rib, w/ One Modified Invector-Plus Choke Tube	499.99
611158292	12	3.5"	28"	MOBL, Vent Rib, w/ One Modified Invector-Plus Choke Tube	499.99
611158391	12	3"	26"	MOBL, Vent Rib, w/ One Modified Invector-Plus Choke Tube	499.99
611158392	12	3"	28"	MOBL, Vent Rib, w/ One Modified Invector-Plus Choke Tube	499.99

DO NOT ATTEMPT THE USE OF 3 1/2" CHAMBERED BARRELS WITH 3" RECEIVERS NOR 3" CHAMBERS WITH 3 1/2" RECEIVERS. \*TO PREVENT DAMAGE TO FOREARMS, THE 12 GAUGE SUPER X3 RIFLED CANTILEVER BARRELS ARE DELIVERED WITH A NEW FOREARM SPECIFICALLY DESIGNED TO FIT OVER THE THICKER, RIFLED BARREL WALL.



SUGGESTED  
RETAIL

DESCRIPTION

ITEM NUMBER	GA.	CHAMBER	BARREL LENGTH	DESCRIPTION	SUGGESTED RETAIL
<b>SUPER X3 FIELD AND TURKEY BARRELS</b>					
611158692	20	3"	28"	MOBL, Vent Rib, w/ One Modified Invector-Plus Choke Tube	\$499.99
611159291	12	3.5"	26"	MAX-5, Vent Rib, w/ One Modified Invector-Plus Choke Tube	499.99
611159292	12	3.5"	28"	MAX-5, Vent Rib, w/ One Modified Invector-Plus Choke Tube	499.99
611159391	12	3"	26"	MAX-5, Vent Rib, w/ One Modified Invector-Plus Choke Tube	499.99
611159392	12	3"	28"	MAX-5, Vent Rib, w/ One Modified Invector-Plus Choke Tube	499.99
611159691	20	3"	26"	MAX-5, Vent Rib, w/ One Modified Invector-Plus Choke Tube	399.99
611159692	20	3"	28"	MAX-5, Vent Rib, w/ One Modified Invector-Plus Choke Tube	399.99
611123253	12	3.5"	24"	Matte Blued, Vent Rib, Tru-Glo Sights, w/ One X-Full Extended Invector-Plus Choke Tube	399.99
611123353	12	3"	24"	Matte Blued, Vent Rib, Tru-Glo Sights, w/ One X-Full Extended Invector-Plus Choke Tube	399.99
611123653	20	3"	24"	Matte Blued, Vent Rib, Tru-Glo Sights, w/ One X-Full Extended Invector-Plus Choke Tube	\$299.99
<b>SUPER X4 FIELD AND TURKEY BARRELS</b>					
615205290	12	3.5"	24"	Matte Blued, Vent Rib, w/ One Modified Invector-Plus Choke Tube	299.99
615205291	12	3.5"	26"	Matte Blued, Vent Rib, w/ One Modified Invector-Plus Choke Tube	299.99
615205292	12	3.5"	28"	Matte Blued, Vent Rib, w/ One Modified Invector-Plus Choke Tube	299.99
615210390	12	3"	24"	Matte Blued, Vent Rib, w/ One Modified Invector-Plus Choke Tube	299.99
615210391	12	3"	26"	Matte Blued, Vent Rib, w/ One Modified Invector-Plus Choke Tube	369.99
615210392	12	3"	28"	Matte Blued, Vent Rib, w/ One Modified Invector-Plus Choke Tube	369.99
615206291	12	3.5"	26"	MOSGB, Vent Rib, w/ One Modified Invector-Plus Choke Tube	369.99
615206292	12	3.5"	28"	MOSGB, Vent Rib, w/ One Modified Invector-Plus Choke Tube	369.99
615206391	12	3"	26"	MOSGB, Vent Rib, w/ One Modified Invector-Plus Choke Tube	369.99
615206392	12	3"	28"	MOSGB, Vent Rib, w/ One Modified Invector-Plus Choke Tube	369.99
615212291	12	3.5"	26"	MOBL, Vent Rib, w/ One Modified Invector-Plus Choke Tube	369.99
615212292	12	3.5"	28"	MOBL, Vent Rib, w/ One Modified Invector-Plus Choke Tube	369.99
615212391	12	3"	26"	MOBL, Vent Rib, w/ One Modified Invector-Plus Choke Tube	369.99
615212392	12	3"	28"	MOBL, Vent Rib, w/ One Modified Invector-Plus Choke Tube	369.99
615207291	12	3.5"	26"	MAX-5, Vent Rib, w/ One Modified Invector-Plus Choke Tube	369.99
615207292	12	3.5"	28"	MAX-5, Vent Rib, w/ One Modified Invector-Plus Choke Tube	369.99
615207391	12	3"	26"	MAX-5, Vent Rib, w/ One Modified Invector-Plus Choke Tube	299.99
615207392	12	3"	28"	MAX-5, Vent Rib, w/ One Modified Invector-Plus Choke Tube	369.99
615205253	12	3.5"	24"	Matte Blued, Cantilever, Tru-Glo Sights, w/ One X-Full Extended Invector-Plus Choke Tube	299.99
615214390	12	3.5"	24"	MOOB, Cantilever, Tru-Glo Sights, w/ One X-Full Extended Invector-Plus Choke Tube	369.99
615215340	12	3"	22"	Matte Blued, Rifled, Cantilever Scope Mount w/ Synthetic Forearm*	299.99

DO NOT ATTEMPT THE USE OF 3 1/2" CHAMBERED BARRELS WITH 3" RECEIVERS NOR 3" CHAMBERS WITH 3 1/2" RECEIVERS. \*TO PREVENT DAMAGE TO FOREARMS, THE 12 GAUGE SUPER X3 RIFLED CANTILEVER BARRELS ARE DELIVERED WITH A NEW FOREARM SPECIFICALLY DESIGNED TO FIT OVER THE THICKER, RIFLED BARREL WALL.



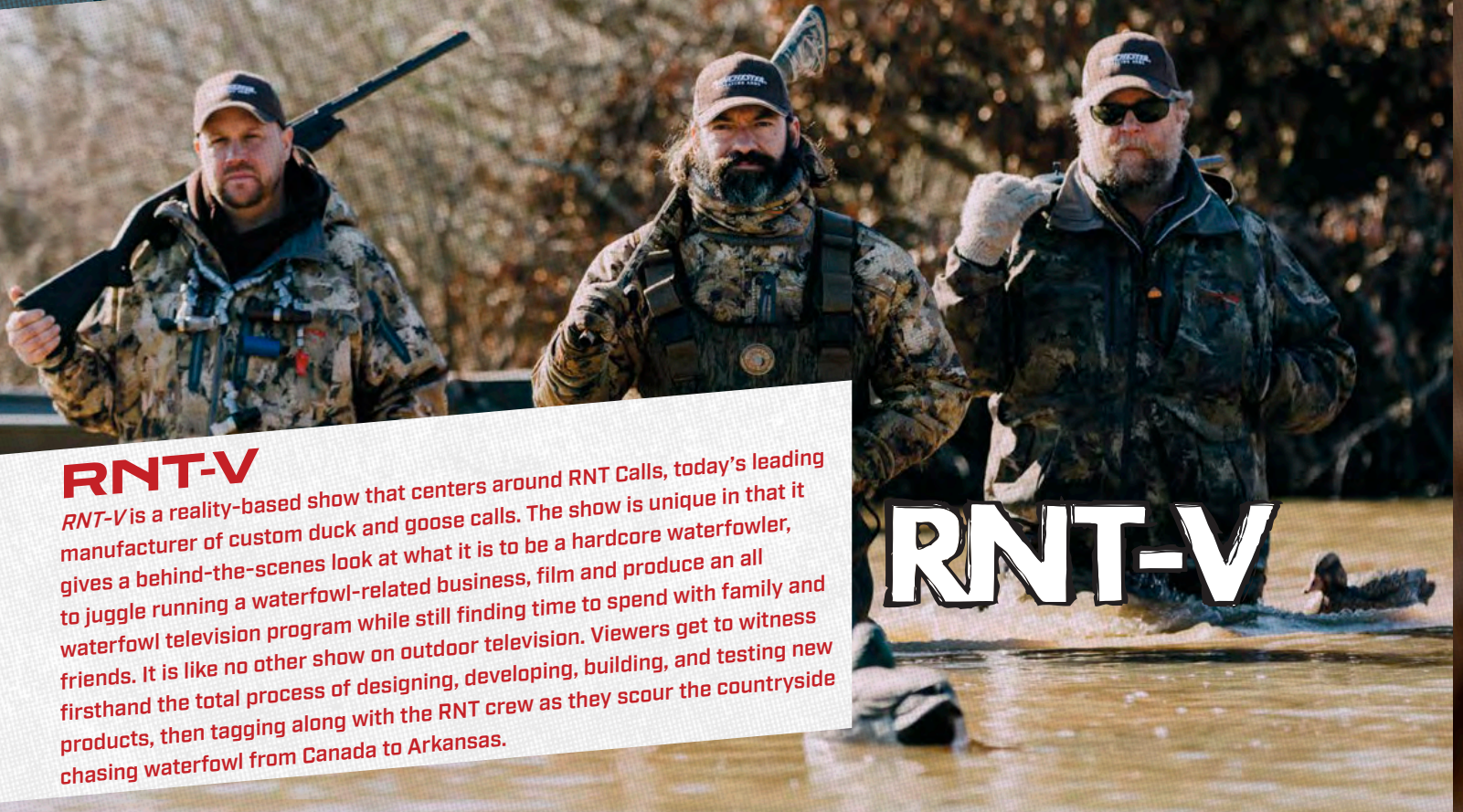

## RNT-V

RNT-V is a reality-based show that centers around RNT Calls, today's leading manufacturer of custom duck and goose calls. The show is unique in that it gives a behind-the-scenes look at what it is to be a hardcore waterfowler, to juggle running a waterfowl-related business, film and produce an all waterfowl television program while still finding time to spend with family and friends. It is like no other show on outdoor television. Viewers get to witness firsthand the total process of designing, developing, building, and testing new products, then tagging along with the RNT crew as they scour the countryside chasing waterfowl from Canada to Arkansas.

## RNT-V

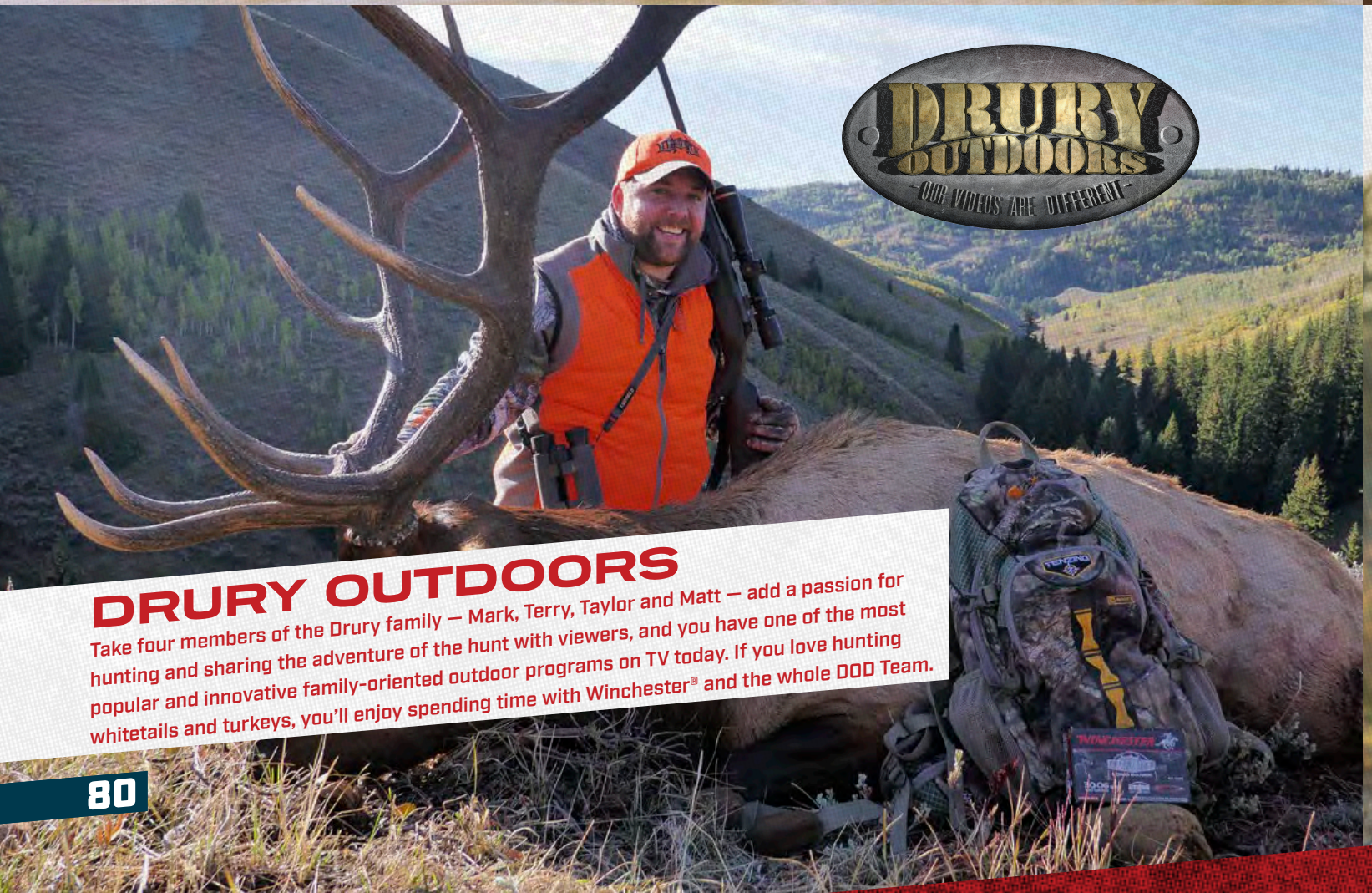

## DRURY OUTDOORS

Take four members of the Drury family — Mark, Terry, Taylor and Matt — add a passion for hunting and sharing the adventure of the hunt with viewers, and you have one of the most popular and innovative family-oriented outdoor programs on TV today. If you love hunting whitetails and turkeys, you'll enjoy spending time with Winchester® and the whole DOD Team.



## WINCHESTER® DEADLY PASSION

Melissa Bachman is an accomplished hunter with a unique ability to share her love for the great outdoors and all things wild with her passionate fans and viewers. Growing up in central Minnesota, surrounded by an avid hunting family filled with love and mentors galore, Melissa pursued her academic life with the same moxie as her passion for hunting. After graduating with honors and armed with degrees in both television broadcasting and Spanish from St. Cloud State University, she trained her sights on a career in outdoor television. Now Melissa spends nearly 200 days a year in the field, hunting, producing and editing for her television show *Winchester Deadly Passion*.



## WINCHESTER® WORLD OF WHITETAIL

*Winchester World of Whitetail* is a hard-core whitetail hunting series featuring low-fence spot-and-stalk action with hosts Ron Spomer and Allen Treadwell. Follow along as they hunt top whitetail locations across the country, hot on the trail of big deer. Ron and Allen are true whitetail experts who reveal their secrets and tricks of the trade for finding and harvesting mature bucks. We'll also vicariously shadow Ron and Allen as they connect with family and friends, prep for their hunts, and showcase their strategies and techniques that allow them continuous success. *Winchester World of Whitetail* combines the legendary performance of Winchester® with America's favorite big-game species.

# EXPERTS

## DROPPED

**DROPPED**  
Brothers Chris and Casey Keefer are well-known personalities in the outdoor and hunting world. After spending their boyhoods hunting and playing ice hockey, the pair has begun to live out their dreams and springboard their lifelong passion for the outdoors into successful careers in big-game guiding, broadcasting and as respected pro-staffers for Winchester Repeating Arms®. Their current TV series *Dropped* literally drops the pair into some of North America's most rugged environments where they must survive by their woodcraft, wits and hunting skills, often for weeks at a time.



**WINCHESTER LIFE™**  
For many people, Winchester® is a lifestyle. Winchester Life is an online series that makes nature and wildlife the stars. Hosts use epic locations and exciting hunts to bring clarity to the outdoor experience and connect at an emotional level with the viewer.





## GOULD BROTHERS® EXHIBITION SHOOTING

With little more than a vision of becoming professional exhibition shooters, the Gould Brothers searched for shotguns that would consistently perform at the highest level. They checked out all the manufacturers and both decided Winchester® was the way to go. Now, after countless rounds of practice and well over a decade of performing live shows on the biggest stages, the Gould Brothers are still relying on the Winchester® Super X® 4 and the Super X® Pump to help them amaze crowds across the country at their one-of-a-kind live exhibition shows.



## GUN IT WITH BENNY SPIES\*

### GUN IT WITH BENNY SPIES

Benny Spies is America's EveryOutdoorsMan® who proudly represents the majority of America's outdoorsmen and women — the weekend warriors and part-time hunters. To Benny, hunting is not just about shooting the biggest deer, the most geese or climbing the highest mountain. It's always been about enjoying the outdoors with family and friends, no matter the outcome of the adventure. For seven seasons Benny produced the *Gun It with Benny Spies* television series on NBC Sports and The Sportsman Channel. Today he continues his entertaining stories through social media. We know the outdoors can be an unforgiving environment. Sometimes things go right and sometimes they don't. Benny has always been among the best at representing both sides of that story!



# WINCHESTER®

REPEATING ARMS

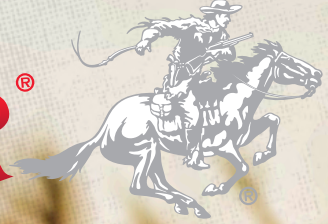

**CUSTOMER SERVICE FOR WINCHESTER® FIREARMS**  
Expect the same great customer service you've become accustomed to over the years. Expert gunsmiths can help you with the most technical questions. There are many Authorized Repair Centers (ARC) throughout the country with gun repair professionals who know your firearm inside and out. If you need service on current models, as well as older models, please contact one of the Authorized Repair Centers or our main Service Center in Arnold, Missouri. Please call (800) 333-3288 or visit online at <http://www.winchesterguns.com/customerservice/partsservice/index.asp> for more information.

**WINCHESTER REPEATING ARMS®  
Customer Service Department**  
275 Winchester Avenue  
Morgan, UT 84050  
(800) 945-5237  
(801) 876-3440

**Parts and Service**  
3005 Arnold Tenbrook Road  
Arnold, MO 63010  
(800) 322-4626



**ALL WINCHESTER® FIREARMS ARE  
SHIPPED WITH A FREE LOCKING DEVICE  
TO ASSIST IN THE SAFE STORAGE  
OF FIREARMS. (NOT SHOWN ACTUAL SIZE.)**



**FOR FIREARMS: WINCHESTERGUNS.COM**  
**FOR AMMUNITION: WINCHESTER.COM**

Owner's manuals for all Winchester® firearms in this catalog or previous catalogs are available upon request at no charge. Owners of Winchester firearms without owner's manuals are encouraged to view one online or request one from our Customer Service Department. Some models and calibers are only made periodically. Winchester Repeating Arms® (WRA) reserves the right to delay, postpone or discontinue production of any Winchester firearm for any reason, and to modify or change product specifications (including those listed in this catalog) without notice. Weights, stock dimensions, wood appearance, etc., may vary slightly between individual firearms. Wood is a natural product. No two pieces are alike and variation between stocks is to be expected. WRA will make every reasonable effort to make sure this catalog is accurate at the time of printing and apologizes for any errors in photographs, descriptions and specifications.

Please note that the following models are made in Japan: Models 1866, 1873, 1885, 1886, 1892, 1894, 1895, 63 and 52B. Model 101 shotguns are made in Belgium and assembled in Portugal. Super X4 shotguns, XPR rifles and Model 70 rifles are made in Portugal. The following trademarks are used with permission from Olin Corporation: Winchester, the Horse and Rider design, Super X, SX4 design, Super X4, Model 1892, Select, Model 101, Model 1300, Model 94, Model 70, Super X Pump, Long Beard, XPR, red W design, Wildcat name and the Wildcat design. Other trademarks used in this catalog: Mossy Oak Shadow Grass Blades, Mossy Oak Break-Up Infinity, Mossy Oak Break-Up Country, Mossy Oak Bottomland, Mossy Oak Obsession and Mossy Oak Duck Blind are registered trademarks of Lyman. Invector-Plus, Dura-Touch and Perma-Cote are trademarks of Browning. TRUGLO is a trademark of TRUGLO, Inc. Marble Arms is a trademark of Marbles Arms. Weaver is a registered trademark of Vista Outdoor. 10/22 is a registered trademark of Sturm, Ruger & Co., Inc.

© Copyright, WRA, December 2018. No part of this catalog may be reproduced without the written permission of Winchester Repeating Arms. Pricing is in U.S. dollars, are approximate and subject to change without notice. Printed in USA. CG18124/18075 Winchester firearms are imported by BACD, Inc. Winchester is a registered trademark of Olin Corporation.

A portion of the sale of every Winchester firearm is proudly donated to the Heritage Fund, which helps to expand the legal defense against politically motivated lawsuits against the hunting and shooting industry. Working together, the rightful tradition of firearms in America will continue.





**WINCHESTER**®

REPEATING ARMS



**WILDCAT**™

WINCHESTER REPEATING ARMS  
275 WINCHESTER AVE., MORGAN, UT  
84050-9333