



WINCHESTER
REPEATING ARMS



SXP NOW IN 3 1/2"

2012

Prices in US \$

WINCHESTER REPEATING ARMS.®

2012. PERFECTION REPEATED.

Proudly presented here for 2012 are new Model 94® and Model 1892 rifles; Super X®3 shotguns, which are still the fastest autoloading shotgun ever and the new Super X® Pump shotgun with 3½" chambers. The timeless Model 70®, still revered as "The Rifleman's Rifle" is commemorating its 75th Anniversary this year, and honored with a superb model in 30-06 Sprg. Plus a few more surprises that will get your trigger finger twitching. Many new models like the 3½" Super X Pump and Historical rifles are guns all built for the demands of today's shooters. Each is backed by the Winchester Repeating Arms reputation for reliability, performance and accuracy. You'll find other brands that have similar models but they'll never have the reputation that stands behind the name Winchester®.



NEW

**MODEL 70
75TH
ANNIVERSARY
SUPER
GRADE**



NEW

**MODEL 94
TAKEDOWN**



NEW

**MODEL
1892
LARGE
LOOP
CARBINE**

| | |
|---|--------------|
| MODEL 70® | 02-15 |
| TECHNICAL FEATURES | 02-03 |
| 75TH ANNIVERSARY SUPER GRADE | 04-05 |
| SUPER GRADE / SPORTER | 06-07 |
| SAFARI EXPRESS / ALASKAN | 08-09 |
| FEATHERWEIGHT / FEATHERWEIGHT COMPACT | 10-11 |
| EXTREME WEATHER SS / COYOTE LIGHT | 12-13 |
| ULTIMATE SHADOW / ULTIMATE SHADOW SS | 14-15 |

| | |
|-----------------------------|--------------|
| MODEL 94® | 16-21 |
| TECHNICAL FEATURES | 16-17 |
| TRAILS END TAKEDOWN | 18-19 |
| SPORTER / SHORT RIFLE | 20-21 |

| | |
|---|--------------|
| HISTORICAL | 22-27 |
| 1892 LARGE LOOP CARBINE / 1892 CARBINE | 22-23 |
| 1886 SHORT RIFLE / 1886 EXTRA LIGHT RIFLE | 24-25 |
| MODEL 71 DELUXE / MODEL 71 STANDARD | 26-27 |

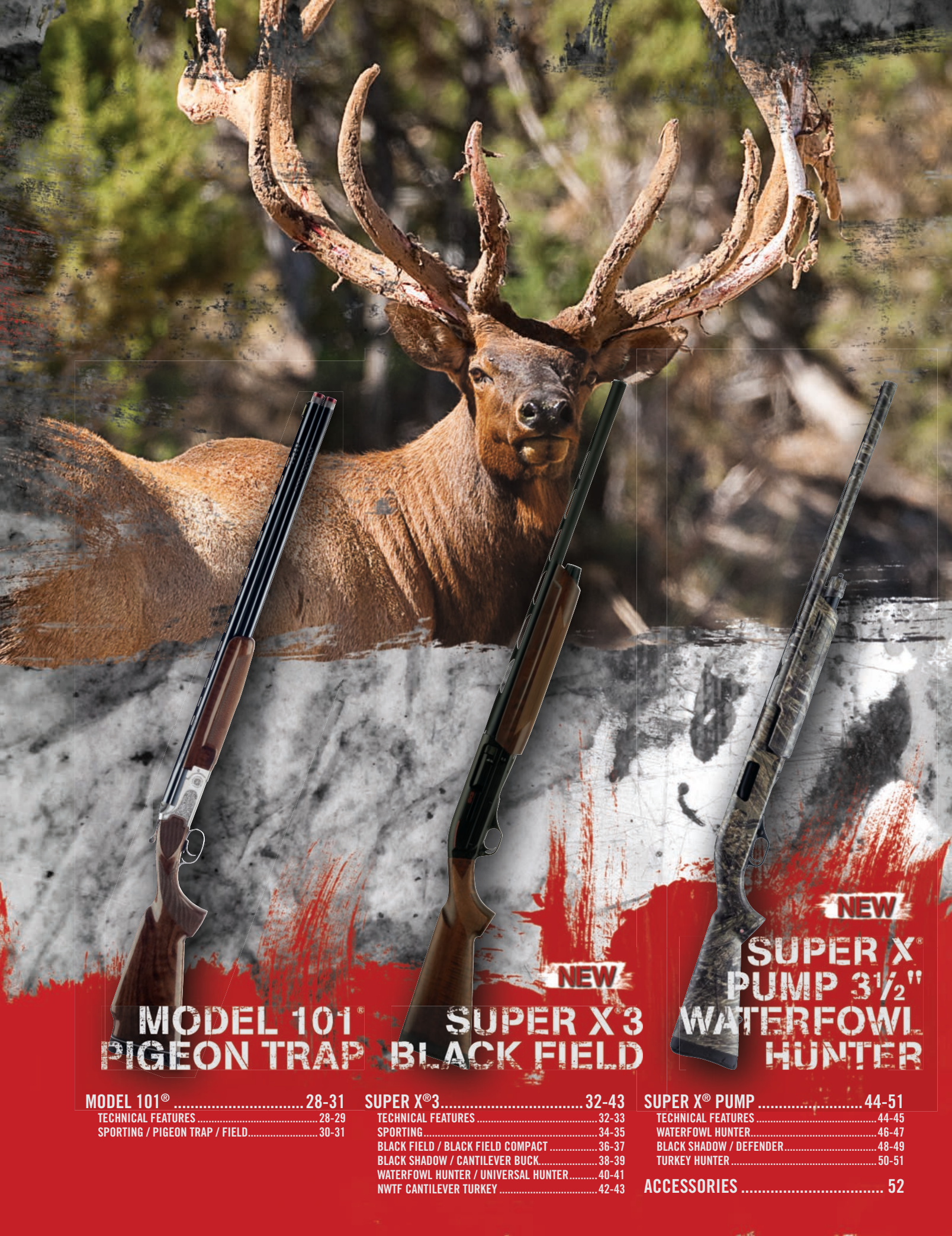

**MODEL 101[®]
PIGEON TRAP**



NEW
**SUPER X³
BLACK FIELD**



NEW
**SUPER X[®]
PUMP 3 1/2"
WATERFOWL
HUNTER**

| | |
|--------------------------------------|--------------|
| MODEL 101[®] | 28-31 |
| TECHNICAL FEATURES | 28-29 |
| SPORTING / PIGEON TRAP / FIELD | 30-31 |

| | |
|---|--------------|
| SUPER X[®]3 | 32-43 |
| TECHNICAL FEATURES | 32-33 |
| SPORTING | 34-35 |
| BLACK FIELD / BLACK FIELD COMPACT | 36-37 |
| BLACK SHADOW / CANTILEVER BUCK | 38-39 |
| WATERFOWL HUNTER / UNIVERSAL HUNTER | 40-41 |
| NWTF CANTILEVER TURKEY | 42-43 |

| | |
|---------------------------------------|--------------|
| SUPER X[®] PUMP | 44-51 |
| TECHNICAL FEATURES | 44-45 |
| WATERFOWL HUNTER | 46-47 |
| BLACK SHADOW / DEFENDER | 48-49 |
| TURKEY HUNTER | 50-51 |
| ACCESSORIES | 52 |

MODEL 70[®] TOUGH. TOUGHER. AND TOUGHEST.

The Model 70 is the best-known, most respected bolt-action rifle in the world. Join us in celebrating its 75th anniversary in 2012. Well known by savvy sportsmen everywhere, it has endured as the Rifleman's Rifle. No other centerfire bolt-action rifle carries a reputation like the real thing — the Winchester[®] Model 70.



ZERO TAKE-UP

Take-up is the distance the triggerpiece travels prior to the sear moving toward release and the shooter feeling resistance. The M.O.A. Trigger System uses a spring to eliminate take-up by keeping the triggerpiece in constant contact with the actuator. Unlike competitors' designs, the unique geometry of the M.O.A. pre-loads the entire trigger system to bias out normal manufacturing tolerances.

ZERO CREEP

Creep is the perceptible movement of the trigger prior to the release of the firing pin and has a negative influence on accuracy causing inconsistency and uncertainty during the pull of the trigger. Creep contributes to jerking the trigger, thus adding to movement of the gun during firing. The 2:1 mechanical advantage created by the M.O.A. Trigger's unique design geometry has virtually eliminated creep in the Model 70[®] M.O.A. Trigger.

ZERO OVERTRAVEL

Overtravel is the rearward movement of the trigger after the firing pin has been released. It can actually jar the gun away from its intended point of aim and is very distracting to the shooter. The Model 70[®] M.O.A. Trigger System is set at the factory to have no perceptible overtravel. When the sear drops, the trigger stops! Where you aim is where you shoot.

1) M.O.A. TRIGGER SYSTEM

The Model 70[®] M.O.A. Trigger System works on the simple principle of the pivoting lever. Pictured at the left are the triggerpiece (A), actuator (B), and sear (C). The housing and all internal parts, pins and springs are precision crafted from stainless steel. In addition, the sear and actuator are Slick Shot[®] electroless nickel Teflon[®] coated for corrosion resistance and smoother operation.

2) 2:1 MECHANICAL ADVANTAGE

The M.O.A.'s triggerpiece offers a wide, smooth face to better distribute finger pressure for a lighter, more sensitive feel. Because of its geometry and 2:1 mechanical advantage, the triggerpiece travels only half the distance of the actuator (2X). Since this distance is cut in half, the perception of creep and overtravel are virtually eliminated.

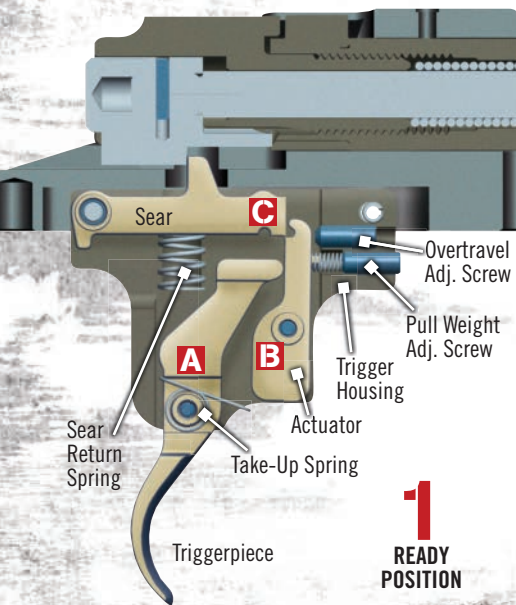

1
READY
POSITION

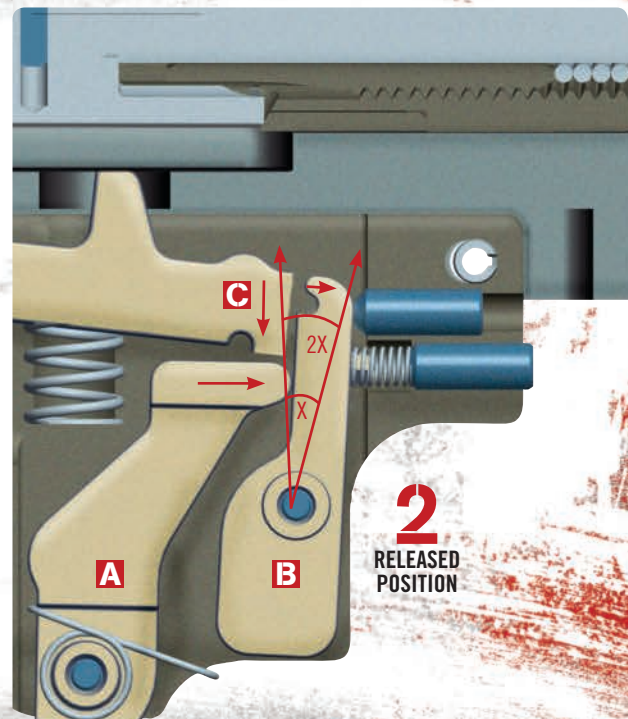

2
RELEASED
POSITION



MADE IN THE USA

The All-American Model 70[®] is built by American craftsmen in Columbia, South Carolina. This is the same state-of-the-art factory where rifles and machine guns used by America's Armed Forces around the world are built. They are made to the exact ISO 9001 standard of quality that Uncle Sam insists upon for military firearms.

WANNA
SEE
TOUGH?
Scan this





Every Model 70® has a **THREE-POSITION SAFETY** that is convenient to operate with the thumb of your firing hand. The design lifts the firing pin away from the sear. When the safety selector is in the middle position, the action can still be operated, allowing unfired cartridges to be cycled with the safety on. It's smooth to engage and easily identifies by sight and feel the safety status of the rifle.

THE STEEL RECEIVER IS FORGED from a solid block of steel. Each forging is precision machined to create a strong, stiff and solid receiver that resists flexing and delivers top accuracy over a lifetime of shooting. The bottom profile of the Model 70® receiver is flat to offer more surface area for bedding. It's then bedded front and rear with a two-part epoxy, eliminating shifts in zero and preserving pinpoint accuracy. The flat bottom contour also resists twisting inside the stock during firing, making it superior to the competitors' round bottom receivers.



THE INTEGRAL RECOIL LUG on the Model 70® is actually forged and machined as part of the receiver. It's not a separate part that's installed between the barrel and the action during assembly. This allows the barrel to be trued in perfect alignment to the front ring of the receiver for greater accuracy. There is nothing to move or shift the barrel out of alignment, ever.



A **BLADE-TYPE EJECTOR** gives you full control when ejecting a fired case. Pull the bolt back slowly and the empty case pops out gently — perfect for target shooters and varminters. Pull the bolt back smartly and the empty case clears the port with greater force.

The trigger guard and magazine frame of each Model 70® feature a solid, **ONE-PIECE BOTTOM METAL** supporting the action through the magazine well. This added rigidity contributes to accuracy and integrity better than two-piece or plastic systems. The hinged magazine floorplate speeds unloading of the cartridges, to avoid having to cycle them through the action. The action and trigger guard are held in place by stout hex head screws.



If there were a single feature responsible for the Model 70® being labeled the "Bolt-Action Rifle of the Century," it would be the classic **CONTROLLED ROUND FEED AND CLAW EXTRACTOR (CRF)** bolt design. The Pre-'64 style massive claw extractor smoothly slips onto and secures the cartridge's base, exerting full control from the very moment it leaves the magazine and enters the chamber, gripping tightly until it's fully ejected. This time-proven design allows an unfired cartridge to be extracted even if it is not yet fully chambered.



You can expect **1 MOA ACCURACY** for three-shot groups from your Model 70® using premium ammo and quality optics under suitable weather and range conditions.



Every Model 70® features a **RECESSED TARGET CROWN** at the muzzle to protect the rifling from nicks and dings. Each bullet exits the barrel uniformly, with ultimate precision.

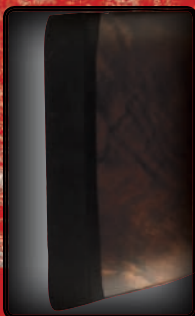

The **RECOIL PAD** on Model 70® rifles (except the Ultimate Shadow) is a premium Pachmayr® Decelerator® recoil pad. This ideally contoured pad's contact area offers optimal protection against felt recoil.



A critical feature of any high-powered rifle is how the barrel is made and set in the stock. Most Model 70® barrels are **COLD HAMMER-FORGED AND FREE-FLOATING** — forged from a solid billet of steel, shaped by massive rotary hammers over a mandrel to create the rifling. Then each barrel is stress relieved to ensure top accuracy, even during the heat of long strings of fire. The Model 70 barrel is free-floating in the stock so that no part of the fore-end touches the barrel, because pressure from the stock adversely influences accuracy.

MODEL 70[®] 75 YEARS OF PERFECTION.

It doesn't happen often that a firearm has the endurance to celebrate its 75th Anniversary. The Winchester[®] Model 70 has earned it, with thousands of sportsmen the world over having relied on its smooth-handling Pre-'64 style action and legendary accuracy. The 75th Anniversary Edition is here, as noble as ever and determined to earn another 75 years as "The Rifleman's Rifle."



SHADOWLINE CHEEKPIECE places your eye in perfect alignment with the scope.



SOLID STEEL FITTED GRIP CAP is elegantly engraved with scroll work.



A FORGED STEEL RECEIVER with elegant engraving creates the ideal foundation for accuracy and reliability. The flat bottom profile has additional surface area for more precise bedding, and the integral recoil lug keeps the barrel and receiver in perfect alignment for the life of the rifle.



BOTTOM METAL has full coverage engraving with scroll patterning and the emblem, "75th Anniversary Model 70."



NEW 75TH ANNIVERSARY SUPER GRADE

■ **GRADE IV / V FULL FANCY WALNUT STOCK WITH SHADOWLINE CHEEKPIECE** allows perfect eye alignment with scope ■ **ENGRAVED STEEL GRIP CAP** adds a touch of class ■ **HIGHLY POLISHED METAL SURFACES** adds style and elegance ■ **SPECIAL 75TH ANNIVERSARY ENGRAVING** on bottom metal honors this legendary rifle ■ **INTEGRATED SLING SWIVEL STUDS** to attach your favorite sling ■ **DECORATIVE STEEL CROSSBOLT** adds a touch of refinement ■ **STEEL ONE-PIECE BOTTOM METAL** adds solid rigidity for better accuracy ■ **M.O.A. TRIGGER SYSTEM** for zero take-up, zero creep and zero overtravel ■ **FORGED STEEL RECEIVER** for strength, engraved and **BEDDED ACTION FRONT AND REAR** to eliminate shifts in zero for exceptional long-range accuracy ■ **THREE-POSITION SAFETY** shows safety status at a glance ■ **INTEGRAL RECOIL LUG** is forged and machined as part of the receiver for perfect barrel alignment and greater accuracy ■ **BLADE-TYPE EJECTOR** for full ejection control ■ **PRE-'64 STYLE CONTROLLED ROUND FEED WITH CLAW EXTRACTOR** fully controls the cartridge from magazine, to chamber, to ejection ■ **RECESSED TARGET CROWN** protects rifling ■ **COLD HAMMER-FORGED FREE-FLOATED BARREL** means pinpoint accuracy ■ **PACHMAYR® DECELERATOR® RECOIL PAD** for optimal protection against felt recoil

**MODEL[®]
70**

| Item Number | Caliber | Magazine Capacity | Barrel Length | Overall Length | Length of Pull | Drop at Comb | Drop at Heel | Nominal Wt. (lbs.) | Rate of Twist | Sugg. Retail |
|--|------------|-------------------|---------------|----------------------------------|----------------------------------|--------------|--------------|-------------------------------|---------------|--------------|
| MODEL 70 75TH ANNIVERSARY SUPER GRADE | | | | | | | | | | |
| NEW 535133228 | 30-06 Sprg | 5 | 24" | 44 ³ / ₄ " | 13 ³ / ₄ " | 1/2" | 1/2" | 8 ¹ / ₄ | 10" | \$1,999.99 |

05

MODEL 70[®] THE RIFLEMAN'S RIFLE.

Its highly polished, deeply-blued steel and finely checkered, fancy grain walnut stock with shadowline cheekpiece define the elegant style of the Model 70 Super Grade. The Model 70 Sporter is pure and traditional; the very essence of a bolt-action rifle for the serious sportsman.

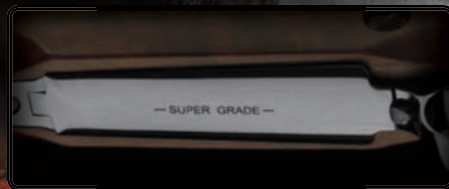

A ONE-PIECE STEEL BOTTOM METAL adds extra rigidity to the stock and action for improved accuracy.



SHADOWLINE CHEEKPIECE is beautifully functional, placing your eye in perfect alignment with the scope.

| | Item Number | Caliber | Magazine Capacity | Barrel Length | Overall Length | Length of Pull | Drop at Comb | Drop at Heel | Nominal Wt. (lbs.) | Rate of Twist | Sugg. Retail |
|-----------------------------|-------------|-------------|-------------------|---------------|----------------|----------------|--------------|--------------|--------------------|---------------|--------------|
| MODEL 70 SUPER GRADE | | | | | | | | | | | |
| | 535107264 | 270 WSM | 3 | 24" | 44¼" | 13¾" | ½" | ½" | 8 | 10" | \$1,339.99 |
| | 535107255 | 300 WSM | 3 | 24" | 44¼" | 13¾" | ½" | ½" | 8 | 10" | 1,339.99 |
| | 535107226 | 270 Win | 5 | 24" | 44¾" | 13¾" | ½" | ½" | 8¼ | 10" | 1,299.99 |
| | 535107228 | 30-06 Sprg | 5 | 24" | 44¾" | 13¾" | ½" | ½" | 8¼ | 10" | 1,299.99 |
| NEW | 535107230 | 7mm Rem Mag | 3 | 26" | 46¾" | 13¾" | ½" | ½" | 8½ | 9½" | 1,339.99 |
| | 535107233 | 300 Win Mag | 3 | 26" | 46¾" | 13¾" | ½" | ½" | 8½ | 10" | 1,339.99 |
| | 535107236 | 338 Win Mag | 3 | 26" | 46¾" | 13¾" | ½" | ½" | 8½ | 10" | 1,339.99 |
| MODEL 70 SPORTER | | | | | | | | | | | |
| | 535108264 | 270 WSM | 3 | 24" | 44¼" | 13¾" | ½" | ½" | 7¼ | 10" | \$919.99 |
| | 535108255 | 300 WSM | 3 | 24" | 44¼" | 13¾" | ½" | ½" | 7¼ | 10" | 919.99 |
| | 535108277 | 325 WSM | 3 | 24" | 44¼" | 13¾" | ½" | ½" | 7¼ | 10" | 919.99 |
| | 535108225 | 25-06 Rem | 5 | 24" | 44¾" | 13¾" | ½" | ½" | 7¼ | 10" | 879.99 |
| | 535108226 | 270 Win | 5 | 24" | 44¾" | 13¾" | ½" | ½" | 7¼ | 10" | 879.99 |
| | 535108228 | 30-06 Sprg | 5 | 24" | 44¾" | 13¾" | ½" | ½" | 7¼ | 10" | 879.99 |
| NEW | 535108229 | 264 Win Mag | 3 | 26" | 46¾" | 13¾" | ½" | ½" | 7¼ | 9" | 919.99 |
| | 535108230 | 7mm Rem Mag | 3 | 26" | 46¾" | 13¾" | ½" | ½" | 7¼ | 9½" | 919.99 |
| | 535108233 | 300 Win Mag | 3 | 26" | 46¾" | 13¾" | ½" | ½" | 7¼ | 10" | 919.99 |
| | 535108236 | 338 Win Mag | 3 | 26" | 46¾" | 13¾" | ½" | ½" | 7¼ | 10" | 919.99 |

SUPER GRADE

- **GRADE IV / V FULL FANCY WALNUT STOCK WITH SHADOWLINE CHEEKPIECE** places your eye in perfect alignment with scope
- **HIGHLY POLISHED METAL SURFACES** add style and elegance
- **ONE-PIECE BOTTOM METAL WITH STEEL FLOORPLATE** adds solid rigidity for better accuracy
- **DECORATIVE STEEL CROSSBOLT** adds a touch of refinement
- **INTEGRATED SLING SWIVEL STUDS** to attach your favorite sling
- **M.O.A. TRIGGER SYSTEM** for zero take-up, zero creep and zero overtravel
- **FORGED STEEL RECEIVER** and **BEDDED ACTION FRONT AND REAR** eliminate shifts in zero for exceptional long-range accuracy
- **BLADE-TYPE EJECTOR** for full ejection control
- **PRE-'64 STYLE CONTROLLED ROUND FEED WITH CLAW EXTRACTOR** fully controls the cartridge from magazine, to chamber, to ejection
- **RECESSED TARGET CROWN** protects rifling
- **COLD HAMMER-FORGED FREE-FLOATED BARREL** means pinpoint accuracy
- **PACHMAYR® DECELERATOR® RECOIL PAD** for optimal protection against felt recoil



(Scope and mounts shown not included.)



RAISED CHEEKPIECE puts your eye in perfect alignment behind a scope.

SPORTER

- **SATIN FINISH GRADE I WALNUT STOCK WITH CUT CHECKERING** and **DELUXE CHEEKPIECE** places your eye in perfect alignment with scope
- **POLISHED METAL SURFACES** add style and elegance
- **ALLOY ONE-PIECE BOTTOM METAL** adds solid rigidity for better accuracy
- **M.O.A. TRIGGER SYSTEM** for zero take-up, zero creep and zero overtravel
- **FORGED STEEL RECEIVER** and **BEDDED ACTION FRONT AND REAR** eliminate shifts in zero for exceptional long-range accuracy
- **THREE-POSITION SAFETY** shows safety status at a glance
- **INTEGRAL RECOIL LUG** is forged and machined as part of the receiver for greater accuracy
- **BLADE-TYPE EJECTOR** for full ejection control
- **PRE-'64 STYLE CONTROLLED ROUND FEED WITH CLAW EXTRACTOR** fully controls cartridge from magazine to chamber to ejection
- **RECESSED TARGET CROWN** protects rifling
- **PACHMAYR® DECELERATOR® RECOIL PAD** for optimal protection against felt recoil

MODEL®
70

MODEL 70[®] ENOUGH GUN FOR ANY GAME.

When planning your hunting trip to Alaska or Africa, be prepared with a reliable rifle of the proper caliber and a proven action you can trust your life to. The Winchester[®] Model 70 Safari Express is the rifle all seasoned dangerous game hunters respect. The new Model 70 Alaskan has returned and it's just like the original with a walnut Monte Carlo stock, rear sight barrel boss, open sights and chambered for the classic cartridges that are tailor-made for big bruins, moose and caribou.

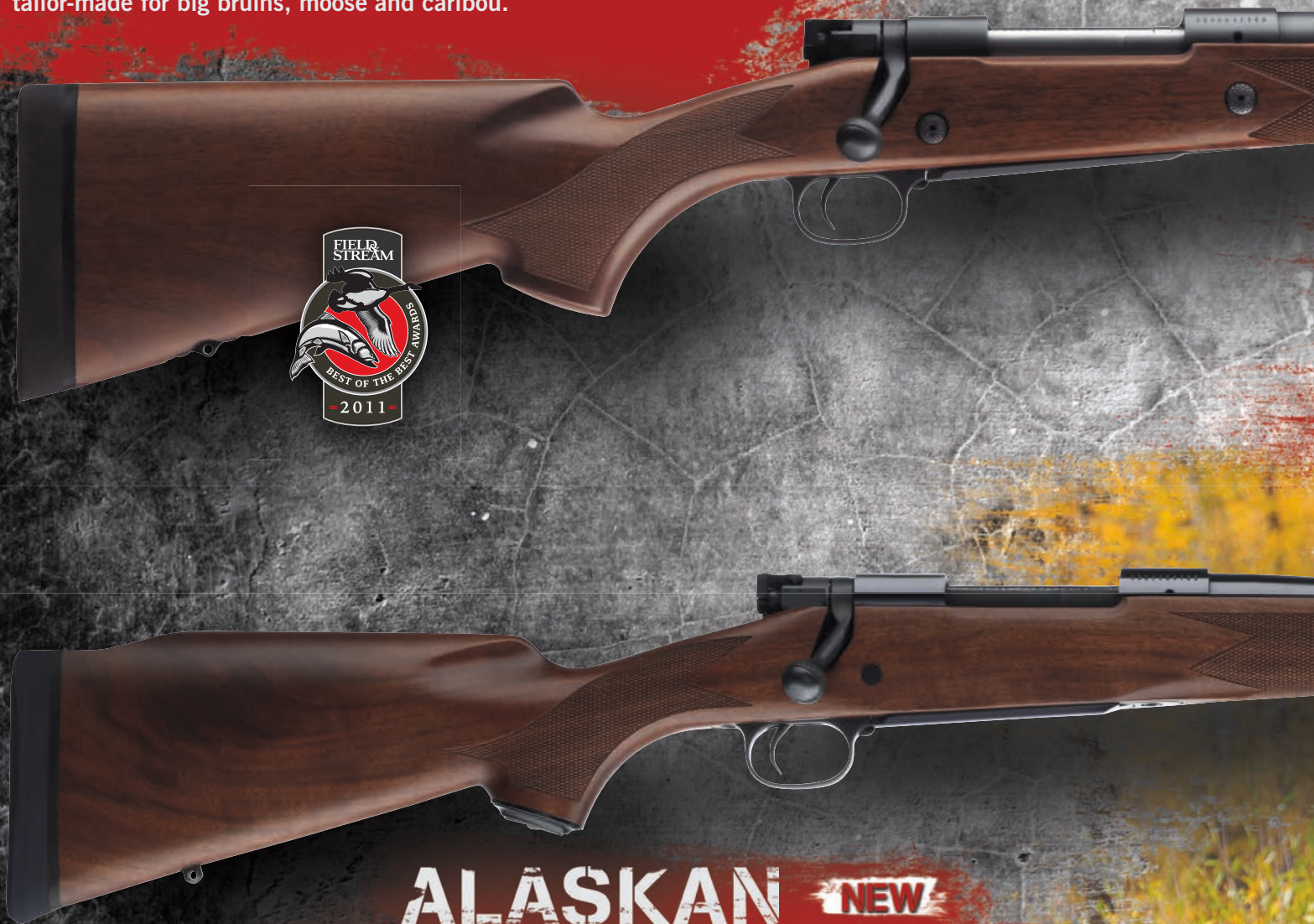

ALASKAN **NEW**

- SATIN FINISH MONTE CARLO WALNUT STOCK WITH CUT CHECKERING looks exquisite and aligns your eye perfectly with open sights or a scope
- FOLDING ADJUSTABLE REAR SIGHT WITH HOODED GOLD BEAD FRONT for fast and sure target acquisition
- POLISHED METAL SURFACES add style and elegance
- ALLOY ONE-PIECE BOTTOM METAL adds solid rigidity for better accuracy
- M.O.A. TRIGGER SYSTEM for zero take-up, zero creep and zero overtravel
- OPEN SIGHTS are ideal for thick cover and quick shots
- INTEGRAL RECOIL LUG forged and machined as part of receiver for greater accuracy
- PRE-'64 STYLE CONTROLLED ROUND FEED WITH CLAW EXTRACTOR fully controls the cartridge from magazine, to chamber, to ejection
- RECESSED TARGET CROWN protects the rifling
- COLD HAMMER-FORGED FREE-FLOATING BARREL means pinpoint accuracy
- PACHMAYR[®] DECELERATOR[®] RECOIL PAD for optimal protection against felt recoil

MODEL[®]
70

08

WINCHESTERGUNS.COM



DOUBLE RECOIL LUGS add strength to the stock and action of the Safari Express to better handle heavy magnum recoil.



The Safari Express has a **DELUXE CHEEKPIECE** that's beautifully functional, placing your eye in perfect alignment behind either open sights or a scope.



TWO CROSS BOLTS and solid, one-piece steel bottom metal and steel floorplate add extra rigidity to the stock of the Safari Express.



SAFARI EXPRESS

- **SATIN FINISH GRADE I WALNUT STOCK WITH CUT CHECKERING** and **DELUXE CHEEKPIECE** allow perfect eye alignment with scope
- **ONE-PIECE BOTTOM METAL WITH STEEL FLOORPLATE** adds solid rigidity for better accuracy
- **MATTE FINISHED METAL SURFACES** reduce glare
- **DOUBLE RECOIL LUGS** add strength to the stock and action
- **DUAL DECORATIVE CROSS BOLTS** add extra strength to receiver
- **FULLY ADJUSTABLE REAR SIGHT WITH HOODED GOLD BEAD FRONT** for fast and sure target acquisition
- **BARREL MOUNTED FRONT SLING SWIVEL** moves sling stud away from hand under heavy recoil, lets rifle sit lower on your back for easy carrying
- **M.O.A. TRIGGER SYSTEM** for zero take-up, zero creep and zero overtravel
- **BLADE-TYPE EJECTOR** for full ejection control
- **PRE-'64 STYLE CONTROLLED ROUND FEED WITH CLAW EXTRACTOR** fully controls the cartridge from magazine, to chamber, to ejection
- **RECESSED TARGET CROWN** protects the rifling
- **COLD HAMMER-FORGED FREE-FLOATING BARREL** means pinpoint accuracy
- **PACHMAYR® DECELERATOR® RECOIL PAD** for optimal protection against felt recoil



BARREL BOSS provides a solid mounting point for the fully-adjustable open rear sight.

| Item Number | Caliber | Magazine Capacity | Barrel Length | Overall Length | Length of Pull | Drop at Comb | Drop at Heel | Nominal Wt. (lbs.) | Rate of Twist | Sugg. Retail |
|--------------------------------|-------------|-------------------|---------------|----------------|----------------|--------------|--------------|--------------------|---------------|--------------|
| MODEL 70 SAFARI EXPRESS | | | | | | | | | | |
| 535116161 | 375 H&H Mag | 3 | 24" | 44¾" | 13¾" | ½" | ½" | 9 | 12" | \$1,419.99 |
| 535116139 | 416 Rem Mag | 3 | 24" | 44¾" | 13¾" | ½" | ½" | 9 | 14" | 1,419.99 |
| 535116144 | 458 Win Mag | 3 | 24" | 44¾" | 13¾" | ½" | ½" | 9 | 14" | 1,419.99 |
| MODEL 70 ALASKAN | | | | | | | | | | |
| NEW 535134128 | 30-06 Sprg | 5 | 25" | 45¾" | 13¾" | ½" | ½" | 8½ | 10" | \$1,269.99 |
| NEW 535134133 | 300 Win Mag | 3 | 25" | 45¾" | 13¾" | ½" | ½" | 8½ | 10" | 1,269.99 |
| NEW 535134136 | 338 Win Mag | 3 | 25" | 45¾" | 13¾" | ½" | ½" | 8½ | 10" | 1,269.99 |

*Drop at Monte Carlo is 2"



MODEL 70[®] STILL AMERICA'S FAVORITE.

The Model 70 Featherweight has remained the all-around, lightweight favorite of seasoned hunters for decades. Its easy-to-carry, lightweight design, dependable cycling and reputation make it excellent for deer, varmints, hogs and antelope. Its fast-handling reputation is even more evident in the Featherweight Compact.



FEATHERWEIGHT COMPACT

- SATIN FINISH WALNUT STOCK WITH CLASSIC FEATHERWEIGHT CUT CHECKERING, retaining the iconic look of this popular model
- POLISHED METAL SURFACES add style and elegance
- ERGONOMIC COMPACT DIMENSIONS ideal for women and younger shooters
- FEATHERWEIGHT BARREL PROFILE for easy all-day carry in the field
- ALLOY ONE-PIECE BOTTOM METAL adds solid rigidity for better accuracy
- M.O.A. TRIGGER SYSTEM for zero take-up, zero creep and zero overtravel
- FORGED STEEL RECEIVER bedded front and rear to eliminate shifts in zero
- INTEGRAL RECOIL LUG is forged and machined as part of the receiver for greater accuracy
- BLADE-TYPE EJECTOR for full ejection control
- RECESSED TARGET CROWN protects rifling
- COLD HAMMER-FORGED FREE-FLOATING BARREL means pinpoint accuracy
- PACHMAYR[®] DECELERATOR[®] RECOIL PAD for optimal protection against felt recoil



FEATHERWEIGHT

- **SATIN FINISH WALNUT STOCK WITH CLASSIC FEATHERWEIGHT CUT CHECKERING AND SCHNABEL FOREARM** retains the iconic look of this popular model
- **POLISHED METAL SURFACES** add style and elegance
- **FEATHERWEIGHT BARREL PROFILE** for easy all-day carry in the field
- **ALLOY ONE-PIECE BOTTOM METAL** adds solid rigidity for better accuracy
- **M.O.A. TRIGGER SYSTEM** for zero take-up, zero creep and zero overtravel
- **FORGED STEEL RECEIVER AND BEDDED ACTION FRONT AND REAR** eliminates shifts in zero for exceptional long-range accuracy
- **BLADE-TYPE EJECTOR** for full ejection control
- **PRE-'64 STYLE CONTROLLED ROUND FEED WITH CLAW EXTRACTOR** fully controls cartridge from magazine, to chamber, to ejection
- **RECESSED TARGET CROWN** protects rifling
- **COLD HAMMER-FORGED FREE-FLOATING BARREL** means pinpoint accuracy
- **PACHMAYR® DECELERATOR® RECOIL PAD** for optimal protection against felt recoil

| | Item Number | Caliber | Magazine Capacity | Barrel Length | Overall Length | Length of Pull | Drop at Comb | Drop at Heel | Nominal Wt. (lbs.) | Rate of Twist | Sugg. Retail |
|---------------------------------------|-------------|-------------|-------------------|---------------|----------------|----------------|--------------|--------------|--------------------|---------------|--------------|
| MODEL 70 FEATHERWEIGHT | | | | | | | | | | | |
| | 535109210 | 22-250 Rem | 5 | 22" | 42¼" | 13¾" | ½" | ¾" | 6¾" | 14" | \$879.99 |
| | 535109212 | 243 Win | 5 | 22" | 42¼" | 13¾" | ½" | ¾" | 6¾" | 10" | 879.99 |
| | 535109218 | 7mm-08 Rem | 5 | 22" | 42¼" | 13¾" | ½" | ¾" | 6¾" | 9½" | 879.99 |
| | 535109220 | 308 Win | 5 | 22" | 42¼" | 13¾" | ½" | ¾" | 6¾" | 12" | 879.99 |
| | 535109264 | 270 WSM | 3 | 24" | 44¼" | 13¾" | ½" | ¾" | 7 | 10" | 919.99 |
| | 535109255 | 300 WSM | 3 | 24" | 44¼" | 13¾" | ½" | ¾" | 7 | 10" | 919.99 |
| | 535109277 | 325 WSM | 3 | 24" | 44¼" | 13¾" | ½" | ¾" | 7 | 10" | 919.99 |
| | 535109225 | 25-06 Rem | 5 | 22" | 42¾" | 13¾" | ½" | ¾" | 7 | 10" | 879.99 |
| | 535109226 | 270 Win | 5 | 22" | 42¾" | 13¾" | ½" | ¾" | 7 | 10" | 879.99 |
| | 535109228 | 30-06 Sprg | 5 | 22" | 42¾" | 13¾" | ½" | ¾" | 7 | 10" | 879.99 |
| NEW | 535109229 | 264 Win Mag | 3 | 24" | 44¾" | 13¾" | ½" | ¾" | 7¼" | 9" | 919.99 |
| | 535109233 | 300 Win Mag | 3 | 24" | 44¾" | 13¾" | ½" | ¾" | 7¼" | 10" | 919.99 |
| MODEL 70 FEATHERWEIGHT COMPACT | | | | | | | | | | | |
| | 535126210 | 22-250 Rem | 5 | 20" | 39½" | 13" | ½" | ¾" | 6½" | 14" | \$879.99 |
| | 535126212 | 243 Win | 5 | 20" | 39½" | 13" | ½" | ¾" | 6½" | 10" | 879.99 |
| | 535126218 | 7mm-08 Rem | 5 | 20" | 39½" | 13" | ½" | ¾" | 6½" | 9½" | 879.99 |
| | 535126220 | 308 Win | 5 | 20" | 39½" | 13" | ½" | ¾" | 6½" | 12" | 879.99 |



MODEL 70[®] WELL SEASONED.

Extreme conditions and hard hunting can take their toll on high-power rifles. The Model 70 Extreme Weather SS (Stainless Steel) is specifically built for heavy hunting in adverse weather of any kind. The Model 70 Coyote Light is the ideal crossover rifle for big game and wary varmints like coyotes. It's a tack driver, with a fluted stainless barrel and vented fore-end. Both rifles have Controlled Round Feed and the M.O.A. Trigger System.



(Scope and mounts shown not included.)

(Scope and mounts shown not included.)

| Item Number | Caliber | Magazine Capacity | Barrel Length | Overall Length | Length of Pull | Drop at Comb | Drop at Heel | Nominal Wt. (lbs.) | Rate of Twist | Sugg. Retail |
|------------------------------------|-------------|-------------------|---------------|----------------|----------------|--------------|--------------|--------------------|---------------|--------------|
| MODEL 70 EXTREME WEATHER SS | | | | | | | | | | |
| 535110212 | 243 Win | 5 | 22" | 42¼" | 13¾" | ½" | ½" | 6¾ | 10" | \$1,199.99 |
| 535110218 | 7mm-08 Rem | 5 | 22" | 42¼" | 13¾" | ½" | ½" | 6¾ | 9½" | 1,199.99 |
| 535110220 | 308 Win | 5 | 22" | 42¼" | 13¾" | ½" | ½" | 6¾ | 12" | 1,199.99 |
| 535110264 | 270 WSM | 3 | 24" | 44¼" | 13¾" | ½" | ½" | 7 | 10" | 1,239.99 |
| 535110255 | 300 WSM | 3 | 24" | 44¼" | 13¾" | ½" | ½" | 7 | 10" | 1,239.99 |
| 535110277 | 325 WSM | 3 | 24" | 44¼" | 13¾" | ½" | ½" | 7 | 10" | 1,239.99 |
| 535110225 | 25-06 Rem | 5 | 22" | 42¼" | 13¾" | ½" | ½" | 7½ | 10" | 1,199.99 |
| 535110226 | 270 Win | 5 | 22" | 42¼" | 13¾" | ½" | ½" | 7½ | 10" | 1,199.99 |
| 535110228 | 30-06 Sprg | 5 | 22" | 42¼" | 13¾" | ½" | ½" | 7½ | 10" | 1,199.99 |
| 535110230 | 7mm Rem Mag | 3 | 26" | 46¼" | 13¾" | ½" | ½" | 7¼ | 9½" | 1,239.99 |
| 535110233 | 300 Win Mag | 3 | 26" | 46¼" | 13¾" | ½" | ½" | 7¼ | 10" | 1,239.99 |
| 535110236 | 338 Win Mag | 3 | 26" | 46¼" | 13¾" | ½" | ½" | 7¼ | 10" | 1,239.99 |

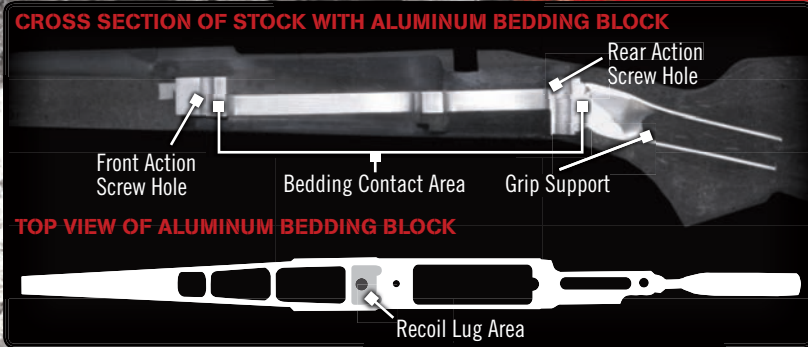

A **ONE-PIECE ALUMINUM BEDDING BLOCK** in the Extreme Weather SS and the Coyote Light is molded right into the stock during manufacturing, providing a solid, rigid base. This feature ensures flat-out reliability. The rifle holds a tight zero, placing every shot where you aim — dead on, in any weather condition, in any season.

EXTREME WEATHER SS

- **BELL AND CARLSON™ TEXTURED STOCK** matte finish, charcoal gray synthetic for no glare, firm grip and rough conditions
- **SCULPTED CHEEKPIECE** allows perfect eye alignment with scope
- **MATTE FINISHED METAL SURFACES** reduce glare
- **ONE-PIECE ALUMINUM BEDDING BLOCK** molded into stock ensures extreme reliability and accuracy
- **ALLOY ONE-PIECE BOTTOM METAL** adds solid rigidity for better accuracy
- **STAINLESS STEEL, FREE-FLOATING FLUTED BARREL** sporter contour for reduced weight, stiffer, improved cooling
- **M.O.A. TRIGGER SYSTEM** for zero take-up, zero creep and zero overtravel
- **FORGED STEEL RECEIVER** and **BEDDED ACTION FRONT AND REAR** eliminate shifts in zero for exceptional long-range accuracy
- **THREE-POSITION SAFETY** shows safety status at a glance
- **BLADE-TYPE EJECTOR** for full ejection control
- **RECESSED TARGET CROWN** protects rifling
- **PACHMAYR® DECELERATOR® RECOIL PAD** for optimal protection against felt recoil

COYOTE LIGHT

- **BELL AND CARLSON™ TEXTURED STOCK** matte finish, charcoal gray synthetic for no glare, firm grip and rough conditions
- **MATTE FINISHED METAL SURFACES** reduce glare
- **DUAL FRONT SLING SWIVEL STUDS** allow mounting a bipod
- **ONE-PIECE ALUMINUM BEDDING BLOCK** molded into stock ensures extreme reliability and accuracy
- **FLOW-THROUGH VENTS IN FOREARM** improve cooling, reduce weight
- **MEDIUM HEAVY STAINLESS STEEL FREE-FLOATING FLUTED BARREL** offers reduced weight, improved cooling
- **ALLOY ONE-PIECE BOTTOM METAL WITH STEEL FLOORPLATE** adds solid rigidity for better accuracy
- **FORGED STEEL RECEIVER AND BEDDED ACTION FRONT AND REAR** eliminate shifts in zero
- **THREE-POSITION SAFETY** shows safety status at a glance
- **INTEGRAL RECOIL LUG** forged and machined as part of the receiver for greater accuracy
- **BLADE-TYPE EJECTOR** for full ejection control
- **PRE-'64 STYLE CONTROLLED ROUND FEED WITH CLAW EXTRACTOR** fully controls cartridge from magazine, to chamber, to ejection
- **RECESSED TARGET CROWN** protects rifling
- **PACHMAYR® DECELERATOR® RECOIL PAD** for optimal protection against felt recoil

| Item Number | Caliber | Magazine Capacity | Barrel Length | Overall Length | Length of Pull | Drop at Comb | Drop at Heel | Nominal Wt. (lbs.) | Rate of Twist | Sugg. Retail |
|------------------------------|------------|-------------------|---------------|----------------|----------------|--------------|--------------|--------------------|---------------|--------------|
| MODEL 70 COYOTE LIGHT | | | | | | | | | | |
| 535115210 | 22-250 Rem | 5 | 24" | 44" | 13½" | ½" | ½" | 7½ | 14" | \$1,099.99 |
| 535115212 | 243 Win | 5 | 24" | 44" | 13½" | ½" | ½" | 7½ | 10" | 1,099.99 |
| 535115220 | 308 Win | 5 | 24" | 44" | 13½" | ½" | ½" | 7½ | 12" | 1,099.99 |
| 535115264 | 270 WSM | 3 | 24" | 44" | 13½" | ½" | ½" | 7½ | 10" | 1,149.99 |
| 535115255 | 300 WSM | 3 | 24" | 44" | 13½" | ½" | ½" | 7½ | 10" | 1,149.99 |
| 535115277 | 325 WSM | 3 | 24" | 44" | 13½" | ½" | ½" | 7½ | 10" | 1,149.99 |



MODEL 70[®] A SHOT FROM THE SHADOWS.

The Model 70 Ultimate Shadow[®] offers a tough, weather-resistant composite stock with raised rubber gripping surfaces for a sure hold in any condition. Every contour and ridge, plus the fitting of stock-to-steel, are carefully engineered to provide maximum strength and efficiency with minimum weight. Available in stainless or blued steel models; these are the ultimate all-weather rifles.



ULTIMATE SHADOW[®]

- **LIGHTWEIGHT GRAY SYNTHETIC STOCK WITH OVERMOLDED RUBBERIZED GRIPPING SURFACES** for enhanced control
- **HAMMER-FORGED STEEL BARREL** matte finish, sporter contour offers reduced weight and pinpoint accuracy
- **POLISHED METAL SURFACES** add style and elegance
- **M.O.A. TRIGGER SYSTEM** for zero take-up, zero creep and zero overtravel
- **THREE-POSITION SAFETY** shows safety status at a glance
- **INTEGRAL RECOIL LUG** is forged and machined as part of the receiver for greater accuracy
- **BLADE-TYPE EJECTOR** for full ejection control
- **ALLOY ONE-PIECE BOTTOM METAL WITH STEEL FLOORPLATE** adds solid rigidity for better accuracy
- **TARGET CROWN** for optimum accuracy
- **WINSORB™ TECHNOLOGY RECOIL PAD** for optimal protection against felt recoil

MODEL 70

| | Item Number | Caliber | Magazine Capacity | Barrel Length | Overall Length | Length of Pull | Drop at Comb | Drop at Heel | Nominal Wt. (lbs.) | Rate of Twist | Sugg. Retail |
|---------------------------------|-------------|-------------|-------------------|---------------|----------------|----------------|--------------|--------------|--------------------|---------------|--------------|
| MODEL 70 ULTIMATE SHADOW | | | | | | | | | | | |
| | 535114212 | 243 Win | 5 | 22" | 42" | 13½" | ¾" | ¾" | 6¾" | 10" | \$759.99 |
| | 535114218 | 7mm-08 Rem | 5 | 22" | 42" | 13½" | ¾" | ¾" | 6¾" | 9½" | 759.99 |
| | 535114220 | 308 Win | 5 | 22" | 42" | 13½" | ¾" | ¾" | 7 | 12" | 759.99 |
| | 535114264 | 270 WSM | 3 | 24" | 44" | 13½" | ¾" | ¾" | 7 | 10" | 799.99 |
| | 535114255 | 300 WSM | 3 | 24" | 44" | 13½" | ¾" | ¾" | 7 | 10" | 799.99 |
| | 535114277 | 325 WSM | 3 | 24" | 44" | 13½" | ¾" | ¾" | 7 | 10" | 799.99 |
| | 535114225 | 25-06 Rem | 5 | 24" | 44¾" | 13¾" | ¾" | ¾" | 7 | 10" | 759.99 |
| | 535114226 | 270 Win | 5 | 24" | 44¾" | 13¾" | ¾" | ¾" | 7 | 10" | 759.99 |
| | 535114228 | 30-06 Sprg | 5 | 24" | 44¾" | 13¾" | ¾" | ¾" | 7 | 10" | 759.99 |
| NEW | 535114229 | 264 Win Mag | 3 | 24" | 44¾" | 13¾" | ½" | ¾" | 7¼" | 9" | 799.99 |
| | 535114230 | 7mm Rem Mag | 3 | 26" | 46¾" | 13¾" | ¾" | ¾" | 7¼" | 9½" | 799.99 |
| | 535114233 | 300 Win Mag | 3 | 26" | 46¾" | 13¾" | ¾" | ¾" | 7¼" | 10" | 799.99 |
| | 535114236 | 338 Win Mag | 3 | 26" | 46¾" | 13¾" | ¾" | ¾" | 7¼" | 10" | 799.99 |

WinSorb™
TECHNOLOGY

WINSORB TECHNOLOGY recoil pad is specifically designed for Ultimate Shadow® composite stocks. It cushions and absorbs sharp recoil, allowing more pleasant shooting at the bench, especially with heavy magnum calibers.

NEW

ULTIMATE SHADOW® SS

- **LIGHTWEIGHT GRAY SYNTHETIC STOCK WITH OVERMOLDED RUBBERIZED GRIPPING SURFACES** for enhanced control
- **MATTE METAL SURFACES** reduce glare
- **STAINLESS STEEL BARREL** matte finish sporter contour offers reduced weight and pinpoint accuracy
- **ALLOY ONE-PIECE BOTTOM METAL WITH STEEL FLOORPLATE** adds solid rigidity for better accuracy
- **M.O.A. TRIGGER SYSTEM** for zero take-up, zero creep and zero overtravel
- **FORGED STEEL RECEIVER** is bedded front and rear to eliminate shifts in zero
- **INTEGRAL RECOIL LUG** is forged and machined as part of the receiver for greater accuracy
- **BLADE-TYPE EJECTOR** for full ejection control
- **PRE-'64 STYLE CONTROLLED ROUND FEED WITH CLAW EXTRACTOR** fully controls cartridge from magazine, to chamber, to ejection
- **TARGET CROWN** for ultimate accuracy
- **WINSORB™ TECHNOLOGY RECOIL PAD** for optimal protection against felt recoil

| | Item Number | Caliber | Magazine Capacity | Barrel Length | Overall Length | Length of Pull | Drop at Comb | Drop at Heel | Nominal Wt. (lbs.) | Rate of Twist | Sugg. Retail |
|------------------------------------|-------------|-------------|-------------------|---------------|----------------|----------------|--------------|--------------|--------------------|---------------|--------------|
| MODEL 70 ULTIMATE SHADOW SS | | | | | | | | | | | |
| NEW | 535135212 | 243 Win | 5 | 22" | 42" | 13½" | ⅜" | ⅜" | 6¾ | 10" | \$929.99 |
| NEW | 535135218 | 7mm-08 | 5 | 22" | 42" | 13½" | ⅜" | ⅜" | 6¾ | 9½" | 929.99 |
| NEW | 535135220 | 308 Win | 5 | 22" | 42" | 13½" | ⅜" | ⅜" | 7 | 12" | 929.99 |
| NEW | 535135264 | 270 WSM | 3 | 24" | 44" | 13½" | ⅜" | ⅜" | 7 | 10" | 969.99 |
| NEW | 535135255 | 300 WSM | 3 | 24" | 44" | 13½" | ⅜" | ⅜" | 7 | 10" | 969.99 |
| NEW | 535135277 | 325 WSM | 3 | 24" | 44" | 13½" | ⅜" | ⅜" | 7 | 10" | 969.99 |
| NEW | 535135225 | 25-06 Rem | 5 | 24" | 44¾" | 13¾" | ⅜" | ⅜" | 7 | 10" | 929.99 |
| NEW | 535135226 | 270 Win | 5 | 24" | 44¾" | 13¾" | ⅜" | ⅜" | 7 | 10" | 929.99 |
| NEW | 535135228 | 30-06 Sprg | 5 | 24" | 44¾" | 13¾" | ⅜" | ⅜" | 7 | 10" | 929.99 |
| NEW | 535135230 | 7mm Rem Mag | 3 | 26" | 46¾" | 13¾" | ⅜" | ⅜" | 7¼ | 9½" | 969.99 |
| NEW | 535135233 | 300 Win Mag | 3 | 26" | 46¾" | 13¾" | ⅜" | ⅜" | 7¼ | 10" | 969.99 |
| NEW | 535135236 | 338 Win Mag | 3 | 26" | 46¾" | 13¾" | ⅜" | ⅜" | 7¼ | 10" | 969.99 |

MODEL 94[®] FOR LEVER LOVIN' HUNTERS.

In 1893, John M. Browning designed a rifle that was a perfect match for the new 30-30 Winchester smokeless cartridge, and ushered in a new era in firearm performance. The Winchester[®] Model 94 is the most popular lever-action rifle in history, and that makes it all the more fun to own today. For brush busting hunting, a new Trails End Takedown model is offered. If you haven't cycled the lever of a Model 94 lately, you'll be pleased with its handling and superb accuracy.

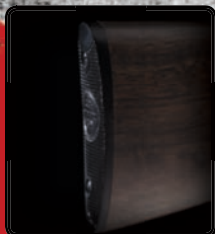

BUTTPLATES are offered in functional "shotgun" style and traditional crescent versions throughout the Model 94[®] line.



ROUND LOCKING BOLT TRUNNIONS like in the original design, ensure smoothness of the entire lever throw. There is little take-up, no hesitation and much less friction. You cycle a smoother, faster lever with less movement and more assurance.

TOP-TANG SAFETY design is easy to see and convenient to operate with the thumb of the firing hand, while the **REBOUNING HAMMER** provides an added margin of safety.



LEVER edges are radiused for a smooth feel. An improved lever slot, not a kidney cut, is closer to the original design for smoother operation.



KNURLED HAMMER SPUR EXTENSION aids in cocking and decocking the hammer when a scope is mounted. A hammer spur extension is included with every Model 94® that has been drilled and tapped for scope mounts. Simply screw it into the threaded hole in the side of the hammer.



REDUCED HAMMER DRAG from a relief cut on the underside of the bolt gives smoother operation during cocking.



MARBLE ARMS® FRONT SIGHT is known the world over for precision and quality. All Model 94® rifles have a Marble Arms front sight with a brass bead.



STEEL LOADING GATE is machined from solid steel with radiused edges like the original. Cartridges feed easily and dependably into the magazine.



ADJUSTABLE REAR SIGHT is a buckhorn style that's adjustable for windage and elevation.

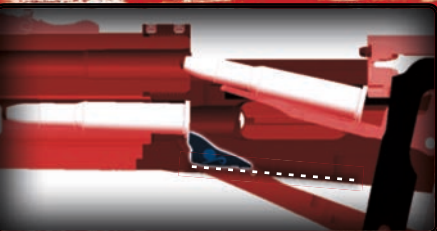
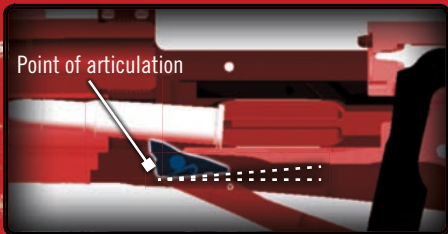

ARTICULATED CARTRIDGE STOP ensures total reliability without damaging the cartridges, allowing them to cycle directly and smoothly with no misfeeds or double feeds under the carrier. It's designed to provide years of reliable service.



BARRELS on Winchester® Model 94® rifles are button-ripped with a recessed crown. Each barrel is triple-checked for ultimate accuracy and precision.



BLUED STEEL FOREARM CAP completes the nostalgic look of the forearm and enhances the overall appearance of the rifle.

MODEL 94[®] TAKE DOWN A TROPHY OR TWO.

The Winchester[®] Model 94[®] is popular throughout the world, and today's production utilizes the latest manufacturing technology to bring you some of the most accurate models ever produced. John M. Browning's original takedown design in the new Trails End Takedown rifle comes apart quickly for easy transporting just about anywhere. The versatile Model 94 is perfect for hunting in thick brush for hogs and other fast-moving game. The Trails End Takedown in 450 Marlin is ported for less muzzle jump, less recoil and is fitted with a Pachmayr[®] Decelerator[®] recoil pad. Select your caliber and get after it.



| | Item Number | Caliber | Magazine Capacity | Barrel Length | Overall Length | Length of Pull | Drop at Comb | Drop at Heel | Nominal Wt. (lbs.) | Rate of Twist | Sugg. Retail |
|-------------------------------------|-------------|------------|-------------------|---------------|----------------|----------------|--------------|--------------|--------------------|---------------|--------------|
| MODEL 94 TRAILS END TAKEDOWN | | | | | | | | | | | |
| NEW | 534191114 | 30-30 Win | 6 | 20" | 38" | 13½" | 1¼" | 1¾" | 6¾ | 12" | \$1,459.99 |
| NEW | 534191160 | 450 Marlin | 6 | 20" | 38" | 13½" | 1¼" | 1¾" | 6¾ | 20" | 1,459.99 |



TAKE DOWN the Model 94® into two compact components — the barrel assembly and the stocked receiver assembly then slip it into your backpack, wrap it in your bedroll, strap it on your ATV or tuck it behind the seat of your truck, boat or bush plane.

REASSEMBLY is easy. Put the two pieces together, give the end of the magazine tube a few turns and you have a full-length rifle with the same superb accuracy as the other models.



NEW

TRAILS END TAKEDOWN

- **WALNUT STOCK** with satin-finish, authentic straight-grip styling and blued steel forearm mean nostalgic, elegant looks
- **TRADITIONAL TAKEDOWN MECHANISM** is easy and fast
- **ROUND LOCKING BOLT TRUNNIONS** ensure a smooth, quick lever throw, less movement, more assurance
- **TOP-TANG SAFETY WITH REBOUNDED HAMMER** easy to see, provides extra margin of safety
- **BOLT RELIEF CUT** reduces hammer drag, smoother cocking
- **RADIUSED LEVER EDGES** for comfort when cycling
- **HAMMER** is drilled and tapped for **KNURLED HAMMER SPUR EXTENSION** (included) aids cocking, decocking hammer when scope is mounted
- **MARBLE ARMS® FRONT SIGHT WITH SEMI-BUCKHORN REAR** for fast, easier sighting
- **ADJUSTABLE REAR SIGHT** gets you on target
- **STEEL LOADING GATE** for reliable, smooth loading
- **TRIPLE CHECKED BUTTON RIFLED BARREL** for ultimate accuracy and precision
- **ARTICULATED CARTRIDGE STOP** gives reliability without damaging cartridges
- **DRILLED AND TAPPED FOR SCOPE MOUNTS** to attach your favorite optics



A THICK PACHMAYR® DECELERATOR® RECOIL PAD is featured on the 450 Marlin model. No other recoil pad matches recoil absorption like a Pachmayr pad.



BARREL PORTING on the 450 Marlin model significantly reduces muzzle jump for multiple shots and also softens felt recoil.

MODEL 94

MODEL 94[®] OWN THE MOST FAMOUS LEVER.

What makes selecting your Winchester[®] Model 94 so exciting is the variety of features you want, and accuracy that will surprise you. The Sporter model with its traditional straight grip stock, blued steel crescent buttplate, and the elegant half-round, half-octagon barrel, is a nostalgic favorite. The satin oil finished walnut stock is finely checkered with double-line bordering. The 20" Short Rifle's barrel makes it quick-swinging, lightweight and lightning fast. It has a rifle-style forearm with blued forearm cap and a full-length magazine. The receivers on both rifles are drilled and tapped for a scope. The Winchester Model 94 — fun to own, more fun to shoot.



| Item Number | Caliber | Magazine Capacity | Barrel Length | Overall Length | Length of Pull | Drop at Comb | Drop at Heel | Nominal Wt. (lbs.) | Rate of Twist | Sugg. Retail |
|-----------------------------|-----------|-------------------|---------------|----------------|----------------|--------------|--------------|--------------------|---------------|--------------|
| MODEL 94 SPORTER | | | | | | | | | | |
| 534178114 | 30-30 Win | 8 | 24" | 42½" | 13½" | 1¼" | 1¾" | 7½ | 12" | \$1,399.99 |
| 534178117 | 38-55 Win | 8 | 24" | 42½" | 13½" | 1¼" | 1¾" | 7½ | 15" | 1,399.99 |
| MODEL 94 SHORT RIFLE | | | | | | | | | | |
| 534174114 | 30-30 Win | 7 | 20" | 38" | 13½" | 1¼" | 1¾" | 6¾ | 12" | \$1,229.99 |
| NEW 534174117 | 38-55 Win | 7 | 20" | 38" | 13½" | 1¼" | 1¾" | 6¾ | 15" | 1,229.99 |



SPORTER

- WALNUT STOCK AND FOREARM WITH TRADITIONAL STYLED CUT CHECKERING adds great looks and firm gripping surface
- RIFLE STYLE FOREARM WITH FOREARM CAP for fast pointing, handsome looks
- DEEPLY BLUED CRESCENT BUTT PLATE nostalgic look
- ROUND LOCKING BOLT TRUNNIONS ensure a smooth, quick lever throw, less movement, more assurance
- TOP-TANG SAFETY WITH REBOUNDED HAMMER easy to see, provides extra margin of safety
- RADIUSSED LEVER EDGES for comfort when cycling
- HAMMER is drilled and tapped for KNURLED HAMMER SPUR EXTENSION (included) aids cocking, decocking hammer when scope is mounted
- BOLT RELIEF CUT reduces drag while cocking hammer
- MARBLE ARMS® FRONT SIGHT WITH SEMI-BUCKHORN REAR for fast, easier sighting
- ADJUSTABLE REAR SIGHT gets you on target
- TRIPLE CHECKED BUTTON RIFLED BARREL for ultimate accuracy and precision
- ARTICULATED CARTRIDGE STOP gives reliability without damaging cartridges
- DRILLED AND TAPPED FOR SCOPE MOUNTS to attach your favorite optics



SHORT RIFLE

- WALNUT STOCK AND FOREARM with satin oil-like finish for traditional look
- RIFLE STYLE FOREARM WITH FOREARM CAP classic look, locks forearm solidly in place
- CHECKERED SYNTHETIC RECOIL PLATE reduces slip and protects stock from nicks and dings
- ROUND LOCKING BOLT TRUNNIONS ensure a smooth, quick lever throw, less movement, more assurance
- TOP-TANG SAFETY WITH REBOUNDED HAMMER easy to see, provides extra margin of safety
- RADIUSSED LEVER EDGES for comfort when cycling
- HAMMER is drilled and tapped for KNURLED HAMMER SPUR EXTENSION (included) aids cocking, decocking hammer when scope is mounted
- BOLT RELIEF CUT reduces drag while cocking hammer
- MARBLE ARMS® FRONT SIGHT WITH SEMI-BUCKHORN REAR for fast, easier sighting
- STEEL LOADING GATE for reliable, smooth loading
- TRIPLE CHECKED BUTTON RIFLED BARREL for ultimate accuracy and precision
- ARTICULATED CARTRIDGE STOP gives reliability without damaging cartridges
- DRILLED AND TAPPED FOR SCOPE MOUNTS to attach your favorite optics

MODEL 94

HISTORICAL YOU KNOW HE'S A COWBOY IF...

The Model 1892 has a rich and colorful lineage. It is very similar to the Model 1886™ with the double locking bolt system, but designed to handle the lighter pistol calibers of yesteryear. Cowboy Action shooters love it. It is ideal for having plain, simple fun. The large loop model is suitable for fast, fun cycling especially when wearing gloves. These special models are limited in production. Don't be disappointed. See your Winchester Repeating Arms® dealer before they are gone.



| | Item Number | Caliber | Magazine Capacity | Barrel Length | Overall Length | Length of Pull | Drop at Comb | Drop at Heel | Nominal Wt. (lbs.) | Rate of Twist | Sugg. Retail |
|--------------------------------------|-------------|------------|-------------------|---------------|----------------|----------------|--------------|--------------|--------------------|---------------|--------------|
| MODEL 1892 LARGE LOOP CARBINE | | | | | | | | | | | |
| NEW | 534190137 | 357 Mag | 10 | 20" | 37½" | 12¾" | 1½" | 1¾" | 6 | 18¾" | \$1,259.99 |
| NEW | 534190124 | 44 Rem Mag | 10 | 20" | 37½" | 12¾" | 1½" | 1¾" | 6 | 26" | 1,259.99 |
| NEW | 534190140 | 44-40 Win | 10 | 20" | 37½" | 12¾" | 1½" | 1¾" | 6 | 36" | 1,259.99 |
| NEW | 534190141 | 45 Colt | 10 | 20" | 37½" | 12¾" | 1½" | 1¾" | 6 | 26" | 1,259.99 |
| MODEL 1892 CARBINE | | | | | | | | | | | |
| | 534177137 | 357 Mag | 10 | 20" | 37½" | 12¾" | 1½" | 1¾" | 6 | 18¾" | \$1,159.99 |
| | 534177124 | 44 Rem Mag | 10 | 20" | 37½" | 12¾" | 1½" | 1¾" | 6 | 26" | 1,159.99 |
| | 534177140 | 44-40 Win | 10 | 20" | 37½" | 12¾" | 1½" | 1¾" | 6 | 36" | 1,159.99 |
| | 534177141 | 45 Colt | 10 | 20" | 37½" | 12¾" | 1½" | 1¾" | 6 | 26" | 1,159.99 |

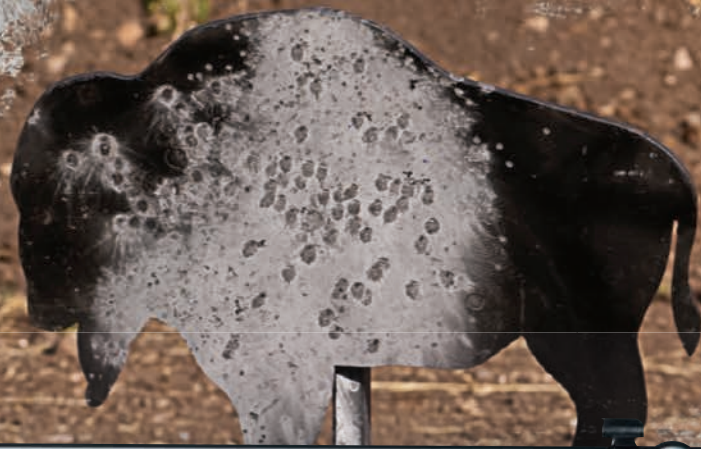

MODEL 1892 **NEW** LARGE LOOP CARBINE

▪ **WALNUT STOCK** Grade I with rich, satin finish, authentic straight-grip, contoured for better feel ▪ **STEEL CONTOURED CARBINE STRAP BUTTPLATE** is quick to shoulder and protects buttstock from damage ▪ **TOP-TANG SAFETY** is easy to see and operate ▪ **REBOUNGING HAMMER** provides added margin of safety ▪ **LARGE LOOP LEVER** with radiused edges, large enough for use with gloves ▪ **MARBLE ARMS® FRONT SIGHT** with brass bead for easier sighting ▪ **ADJUSTABLE REAR SIGHT** gets you on target with any ammo ▪ **SADDLE RING** attaches rifle to the saddle ▪ **STEEL LOADING GATE** for smoother loading ▪ **BARREL** is button-rifled with recessed crown to protect rifling for consistent bullet departure and ultimate accuracy



MODEL 1892 CARBINE

▪ **WALNUT STOCK** Grade I with rich, satin finish, authentic straight-grip, contoured for better feel ▪ **STEEL CARBINE BUTTPLATE** is quick to shoulder and protects buttstock from damage ▪ **TOP-TANG SAFETY** is easy to see and operate ▪ **REBOUNGING HAMMER** provides added margin of safety ▪ **LOOP LEVER** with radiused edges for smoothness ▪ **MARBLE ARMS® FRONT SIGHT** with brass bead for easier sighting ▪ **ADJUSTABLE REAR SIGHT** gets you on target with any ammo ▪ **SADDLE RING** attaches rifle to the saddle ▪ **STEEL LOADING GATE** for smoother loading ▪ **BARREL** is button-rifled with recessed crown to protect rifling for consistent bullet departure and ultimate accuracy



A **SADDLE RING** is always eye-catching — typical of many carbine models, securing the rifle to the saddle for quick access.

HISTORICAL

HISTORICAL. BIG GUNS. BIG STEAKS.

The Model 1886™ was designed to handle the powerful centerfire cartridges of the period, like the timeless 45-70 Government. You'll find that famous, hard-hitting caliber here in two superb choices of the Model 1886. Bear, elk, moose and bison are fair targets for this nostalgic rifle and cartridge. Slide the Extra Light Rifle into your scabbard because it was made for the saddle. You owe it to yourself to take a Winchester® Model 1886 on your next big game hunt.



| | Item Number | Caliber | Magazine Capacity | Barrel Length | Overall Length | Length of Pull | Drop at Comb | Drop at Heel | Nominal Wt. (lbs.) | Rate of Twist | Sugg. Retail |
|-------------------------------------|-------------|------------|-------------------|---------------|----------------|----------------|--------------|--------------|--------------------|---------------|--------------|
| MODEL 1886 SHORT RIFLE | | | | | | | | | | | |
| | 534175142 | 45-70 Govt | 8 | 24" | 43" | 13¼" | 1¼" | 2" | 8¾ | 20" | \$1,339.99 |
| MODEL 1886 EXTRA LIGHT RIFLE | | | | | | | | | | | |
| NEW | 534053142 | 45-70 Govt | 4 | 22" | 40½" | 13¼" | 1¼" | 1½" | 7¼ | 20 | \$1,269.99 |



MODEL 1886™ SHORT RIFLE

- WALNUT STOCK GRADE I, SATIN FINISH for deep grain beauty, STRAIGHT GRIP for genuine good looks and fast handling
- STEEL CRESCENT BUTTPLATE adds traditional, typical look, protects the buttstock ▪ FULL-LENGTH MAGAZINE provides balance, classic lines and higher capacity ▪ TOP-TANG SAFETY is easy to see and operate ▪ REBOUNDED HAMMER provides added margin of safety ▪ MARBLE ARMS® FRONT SIGHT with brass bead for easier sighting ▪ ADJUSTABLE REAR SIGHT gets you on target with any ammo ▪ STEEL LOADING GATE for smoother loading ▪ BARREL is button-rifled with recessed crown for ultimate accuracy
- RECEIVER is drilled and tapped for traditional side mounted receiver sight



MODEL 1886™ **NEW** EXTRA LIGHT RIFLE

- WALNUT STOCK GRADE I, SATIN FINISH for deep grain beauty, STRAIGHT GRIP for genuine good looks and fast handling
- STEEL BUTTPLATE is quick to shoulder and protects the stock ▪ HALF-LENGTH MAGAZINE reduces weight and is fast out of the scabbard ▪ TOP-TANG SAFETY is easy to see and operate ▪ REBOUNDED HAMMER provides added margin of safety ▪ MARBLE ARMS® FRONT SIGHT with brass bead for easier sighting ▪ ADJUSTABLE REAR SIGHT gets you on target with any ammo ▪ STEEL LOADING GATE for smoother loading ▪ BARREL button-rifled with recessed crown for ultimate accuracy ▪ RECEIVER is drilled and tapped for traditional side mounted receiver sight

HISTORICAL CYCLE A SMOOTH ACTION.

In 1936, the Winchester® Model 71™ lever-action rifle was introduced to handle one cartridge — the hard-hitting 348 Winchester. It proved excellent for stopping all big game at close range, with the Model 71 being well suited for its delivery. The curved lever, conforming to the Deluxe Model's Grade IV checkered walnut pistol grip stock add to the nostalgic profile of this historic rifle.



| | Item Number | Caliber | Magazine Capacity | Barrel Length | Overall Length | Length of Pull | Drop at Comb | Drop at Heel | Nominal Wt. (lbs.) | Rate of Twist | Sugg. Retail |
|--------------------------|-------------|---------|-------------------|---------------|----------------------------------|----------------------------------|----------------------------------|---------------------------------|--------------------|---------------|--------------|
| MODEL 71 DELUXE | | | | | | | | | | | |
| NEW | 534192183 | 348 Win | 4 | 24" | 43 ³ / ₈ " | 13 ³ / ₄ " | 13 ³ / ₈ " | 1 ¹ / ₂ " | 8 | 12" | \$1,659.99 |
| MODEL 71 STANDARD | | | | | | | | | | | |
| NEW | 534187183 | 348 Win | 4 | 24" | 43 ³ / ₈ " | 13 ³ / ₄ " | 13 ³ / ₈ " | 1 ¹ / ₂ " | 8 | 12" | \$1,469.99 |



MODEL 71™ DELUXE

NEW

- **GRADE IV WALNUT, FULL PISTOL GRIP STOCK WITH CLASSIC RIFLE STYLE FOREARM, HIGH GLOSS FINISH, CUT CHECKERING** blued steel forearm cap for the genuine look, feel and finish as original from muzzle to buttstock
- **STRAIGHT CHECKERED STEEL BUTTPLATE** is quick to shoulder and protects buttstock
- **ROUND, TAPERED 24" BARREL WITH HALF MAGAZINE TUBE**, holds 4 rounds of 348 Win.
- **OPEN BUCKHORN TYPE SIGHTS WITH HOODED FRONT RAMP SIGHT** gets you on target quickly
- **TOP-TANG SAFETY** is easy to see and operate
- **REBOUNGING HAMMER** provides added margin of safety
- **STEEL LOADING GATE** for smoother loading
- **RECEIVER** is drilled and tapped for traditional side mount receiver sight



MODEL 71™ STANDARD

NEW

- **SELECT WALNUT, FULL PISTOL GRIP STOCK WITH CLASSIC RIFLE STYLE FOREARM, SATIN FINISH**, blued steel forearm cap for the genuine look, feel and finish as original from muzzle to buttstock
- **STRAIGHT CHECKERED STEEL BUTTPLATE** is quick to shoulder and protects buttstock
- **ROUND, TAPERED 20" BARREL WITH HALF MAGAZINE TUBE**, holds 4 rounds of 348 Win.
- **OPEN BUCKHORN TYPE SIGHTS WITH HOODED FRONT RAMP SIGHT** gets you on target quickly
- **TOP-TANG SAFETY** is easy to see and operate
- **REBOUNGING HAMMER** provides added margin of safety
- **STEEL LOADING GATE** for smoother loading
- **RECEIVER** is drilled and tapped for traditional side mount receiver sight

HISTORICAL

MODEL 101[®] OVER AND UNDER ELEGANCE.

If you are considering a fast-handling, smooth-swinging over and under shotgun, bring a Model 101 up to your shoulder at your Winchester Repeating Arms[®] dealer. It offers Belgian-made craftsmanship, engraved steel and finely cut checkered walnut at a low price few over and unders can match. Its strong action was tested by firing 25,000 shells without a single part failure. The low-profile receiver and mild recoil make the Model 101 extremely pleasant to shoot all day. The Model 101 begs to be examined and yearns to be yours.

Today's Model 101[®] features the same **FAMILIAR DIMENSIONS** set long ago by the original. The familiar drop at comb and narrow, comfortable grip insure time-tested comfort and performance.



The Model 101[®] has the drop on the original with the advantage of a **LOW-PROFILE RECEIVER**. This means that recoil occurs in-line, directly back for faster follow-up shots with less muzzle jump. Also, your forward hand can be closer to the bore centerline, bringing your hands, face and sighting plane into a more natural alignment for more intuitive and accurate shooting.



An **ADJUSTABLE COMB** stock allows you to modify individual height and cast on/off custom fitting in just seconds. (Hex wrench is included.)

Every Model 101[®] has **FINELY CUT CHECKERING** to improve grip and add artistic elegance to the walnut stock and forearm.



An **ADJUSTABLE TRIGGER** lets you fine tune your precise length of pull for more comfortable shooting on Pigeon models. (Hex wrench is included.)



Getting pounded by your gun is now a thing of the past with the patented **PACHMAYR[®] DECELERATOR[®] RECOIL PAD** with snag-free heel. Found on all Model 101[®] shotguns, it reduces felt recoil to very manageable levels, even when shooting heavy magnum loads.



Sporting and Field models have an elegant fitted **GRIP CAP**.

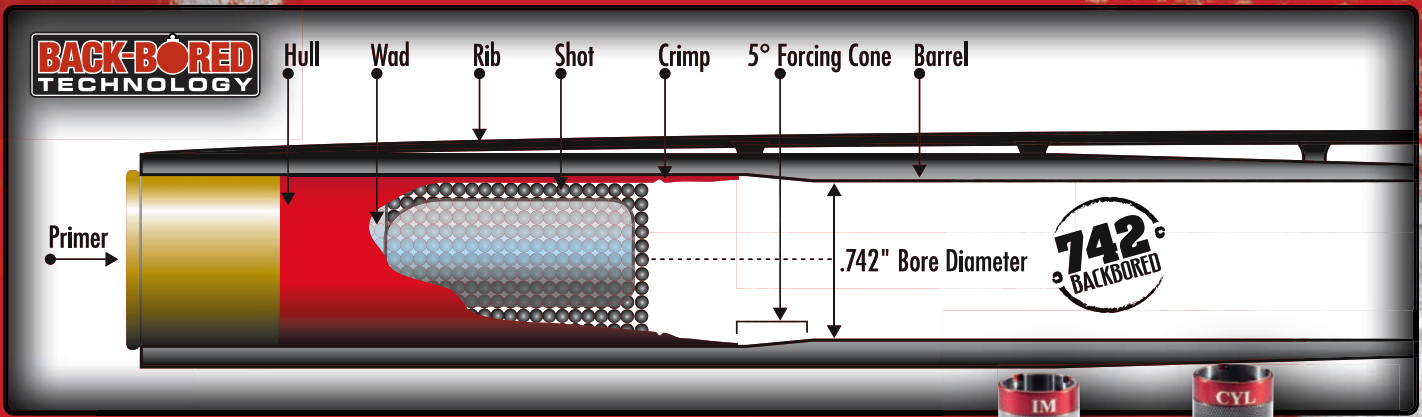

.742" BACK-BORED TECHNOLOGY is based on extensive research and testing showing that when it comes to back-boring, .742" is the ideal 12 gauge interior barrel diameter, ensuring tight, consistent patterns. Any larger and gases blow by the shot cup and reduce pellet velocity. Too tight and the pellets are deformed as they pass through the forcing cone, causing poor ballistic performance.



CHROME PLATED CHAMBERS AND BORES are found in all Winchester® Model 101® shotguns. This critical plating provides protection from thousands of heavy, high density, abrasive loads. This extra feature virtually eliminates wear and tear caused by the elements.



TOUGH STEEL HINGE areas bear tension from recoil with each shot, so the Model 101® is built with surfaces that are 49% larger than many competitors. The surfaces are machined simultaneously with the hinge, ensuring perfect alignment.



From the field to the range, the **INVECTOR-PLUS™ CHOKE TUBE SYSTEM** is the world's favorite. All Model 101® shotguns come with either extended Signature or flush-mounted Invector-Plus™ tubes, depending on the model. Additional tubes are available at your local Winchester Repeating Arms® dealer.

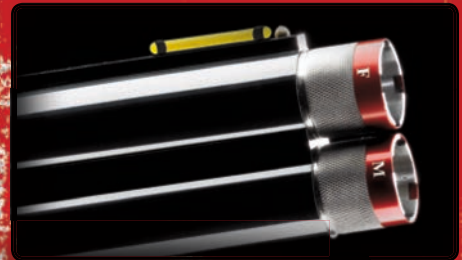

TRUGLO



The Model 101® shotgun's **LOCKING LUGS** have 30% more contact surface than the competition for an action that's the strongest in the industry and built to last!



MODEL 101[®] TWO REFINED SHOTS.

Serious hunters and sport shooters realize that a comfortable shotgun is critical for success and increases your fun. All Winchester[®] Model 101 shotguns feature a low-profile receiver that places your forward hand and eye closer to the centerline of the bore, giving you faster target acquisition with less felt recoil. What you get is a crisp, controlled swing, resulting in more hits and higher scores. See for yourself by shouldering a classic Winchester Model 101 at your dealer.



BACK-BORED TECHNOLOGY **TRUGLO**

SPORTING



T-Wrench, LF, IM, M, IC, SK

- **HIGH GLOSS GRADE II / III WALNUT STOCK WITH 20 LINES-PER-INCH CUT CHECKERING** looks elegant and improves grip
- **TRADITIONAL MODEL 101[®] DIMENSIONS** give you the advantage in performance and handsome looks
- **LOW-PROFILE RECEIVER** gives you faster target acquisition, a more controlled swing and less felt recoil
- **TRUGLO[®] TRU-BEAD[®] INTERCHANGEABLE FIBER-OPTIC FRONT SIGHT** offers a true, precise sight picture
- **742" BACK-BORED BARRELS** reduce recoil and shot deformation
- **STEEL GRIP CAP** on Sporting and Field models adds class
- **EXTENDED SIGNATURE INVECTOR-PLUS[™] CHOKE TUBES** offer uniform, reliable patterns
- **ADJUSTABLE TRIGGER** for your exact length of pull
- **HARD CHROME PLATED CHAMBERS AND BORES** stand up to heavy use and corrosion
- **49% MORE HINGE SURFACE AREA** than the competition provides more strength for long-term wear
- **30% MORE LOCKING LUG CONTACT AREA** for greater strength, keeps action tighter, longer, minimizing wear
- **PACHMAYR[®] DECELERATOR[®] RECOIL PAD** offers optimal protection against felt recoil

| | Item Number | Gauge | Barrel Length | Chamber | Choke Tubes Included | Overall Length | Length of Pull | Drop at Comb | Drop at Heel | Nominal Wt. (lbs.) | Sugg. Retail |
|--|-------------|-------|---------------|---------|----------------------|----------------|----------------|--------------|--------------|--------------------|--------------|
| MODEL 101 PIGEON TRAP | | | | | | | | | | | |
| | 513057493 | 12 | 30" | 2¾" | XF, F, IM | 47½" | 14½" | 1½" | 2¾" | 7½ | \$2,469.99 |
| | 513057494 | 12 | 32" | 2¾" | XF, F, IM | 49½" | 14½" | 1½" | 2¾" | 7½ | 2,469.99 |
| MODEL 101 PIGEON TRAP (ADJUSTABLE COMB) | | | | | | | | | | | |
| | 513059493 | 12 | 30" | 2¾" | XF, F, IM | 47½" | 14½" | 1½"* | 2¾"* | 7½ | \$2,629.99 |
| | 513059494 | 12 | 32" | 2¾" | XF, F, IM | 49½" | 14½" | 1½"* | 2¾"* | 7½ | 2,629.99 |
| MODEL 101 SPORTING | | | | | | | | | | | |
| | 513054492 | 12 | 28" | 2¾" | LF, IM, M, IC, SK | 45½" | 14½" | 1¾" | 2¾" | 7½ | \$2,319.99 |
| | 513054493 | 12 | 30" | 2¾" | LF, IM, M, IC, SK | 47½" | 14½" | 1¾" | 2¾" | 7¼ | 2,319.99 |
| | 513054494 | 12 | 32" | 2¾" | LF, IM, M, IC, SK | 49½" | 14½" | 1¾" | 2¾" | 7¾ | 2,319.99 |
| MODEL 101 FIELD | | | | | | | | | | | |
| | 513046371 | 12 | 26" | 3" | F, M, IC | 43¼" | 14¼" | 1¾" | 2¾" | 6¾ | \$1,869.99 |
| | 513046361 | 12 | 28" | 3" | F, M, IC | 45¼" | 14¼" | 1¾" | 2¾" | 7 | 1,869.99 |

*Adjustable comb stock dimensions are measured with comb in the lowest position.

30

WINCHESTERGUNS.COM



The Model 101® Pigeon Trap is available with an adjustable comb stock.



Every Model 101® Sporting/Trap shotgun comes with a durable, fitted ABS hard case embossed with the Winchester® logo.



BACK-BORED TECHNOLOGY **TRUGLO**



T-Wrench, XF, F, IM

PIGEON TRAP

▪ **HIGH GLOSS GRADE II / III WALNUT STOCK WITH 20 LINES-PER-INCH CUT CHECKERING** looks elegant and improves grip ▪ **ADJUSTABLE COMB OPTION AVAILABLE** helps fit the stock exactly to your shooting dimensions ▪ **LOW-PROFILE NICKEL PLATED RECEIVER WITH CLASSIC PIGEON ENGRAVING** gives you faster target acquisition, more controlled swing, less felt recoil ▪ **TRUGLO® TRU-BEAD® INTERCHANGEABLE FIBER-OPTIC FRONT SIGHT** offers true, precise sight picture ▪ **TRADITIONAL MODEL 101® DIMENSIONS** give you the advantage in performance and handsome looks ▪ **EXTENDED SIGNATURE INVECTOR-PLUS™ CHOKE TUBES** offer uniform, reliable patterns ▪ **.742" BACK-BORED BARRELS** reduce recoil and provide ideal ballistic performance ▪ **PORTED BARRELS** reduce muzzle jump for more accurate follow-up shots ▪ **ADJUSTABLE TRIGGER** for your exact length of pull ▪ **HARD CHROME PLATED CHAMBERS AND BORES** stand up to heavy use and corrosion ▪ **WHITE LINE SPACER PACHMAYR® DECELERATOR® RECOIL PAD** offers optimal protection against felt recoil



BACK-BORED TECHNOLOGY



F, M, IC

FIELD

▪ **HIGH GLOSS GRADE II / III WALNUT STOCK WITH 20 LINES-PER-INCH CUT CHECKERING** looks elegant and improves grip ▪ **LOW-PROFILE RECEIVER** gives you faster target acquisition, more controlled swing, less recoil ▪ **STEEL GRIP CAP** on Sporting and Field models adds class, looks elegant ▪ **WHITE LINE SPACER PACHMAYR® DECELERATOR® RECOIL PAD** offers optimal protection against felt recoil ▪ **.742" BACK-BORED BARRELS** reduce recoil and shot deformation ▪ **HARD CHROME PLATED CHAMBERS AND BORES** stand up to heavy use and corrosion ▪ **INVECTOR-PLUS™ CHOKE TUBES** offer uniform, reliable patterns ▪ **49% MORE HINGE SURFACE AREA** than the competition provides more strength for long-term wear ▪ **30% MORE LOCKING LUG CONTACT AREA** for greater strength, keeps action tighter, longer, minimizing wear

MODEL 101

SUPER X[®]3 HOW FAST IS SUPER X3 FAST?

12 shots in 1.442 seconds — that's how fast the Winchester[®] Super X3 is, and because it fits you so naturally, your balanced swing becomes a perfect extension of your body from impact to follow-through. You'll love the softer recoil provided by the Inflex Technology recoil pad, the adjustable stock and the way this autoloader keeps itself clean. Additional innovative features that no other autoloader can match contribute to your accuracy and overall enjoyable shooting, all weekend long.

12 SHOTS IN
1.442
SECONDS



There is no reason to put up with a shotgun that does not fit you, because proper stock fit is critical to comfortable and accurate shooting. Most Super X[®]3 shotguns come with **LENGTH OF PULL SPACERS** that fit between the stock and the recoil pad, allowing easy adjustments to length of pull. When the length of pull is adjusted properly, you'll find you can shoulder the gun with ease and confidence, and the felt recoil you experience is greatly diminished. Adjustments range from 13³/₄" to 14¹/₄" on wood stocks and from 14¹/₄" to 14³/₄" on composite models.



Getting pounded by your gun's recoil is a thing of the past with the **INFLEX TECHNOLOGY RECOIL PAD**. Specially shaped rib structures located inside the pad help direct and channel the recoil impulse, moving the comb down and away from your cheek to reduce felt recoil to very manageable levels, even when shooting heavy magnum loads. A hard heel insert on the pad makes mounting the Super X[®]3 snag-free.

SHIM CAST ADJUSTMENT

SHIM COMB DROP ADJUSTMENT

| | | |
|--|-------------------------------------|--|
| 1- Neutral cast. Raises the comb. | 2- Neutral cast. Neutral comb. | 3- Neutral cast. Lowers the comb. |
| 1R/1L - Changes cast. Raises the comb. | 2R/2L - Changes cast. Neutral comb. | 3R/3L - Changes cast. Lowers the comb. |

Every shooter is different, and no one stock will perfectly fit every person. **CAST/DROP SHIMS** on the Composite Super X[®]3 models allow you to easily adjust both cast on/cast off and drop at comb over a 1/4" range simply by inserting one of the six special shims between the receiver and the buttstock.

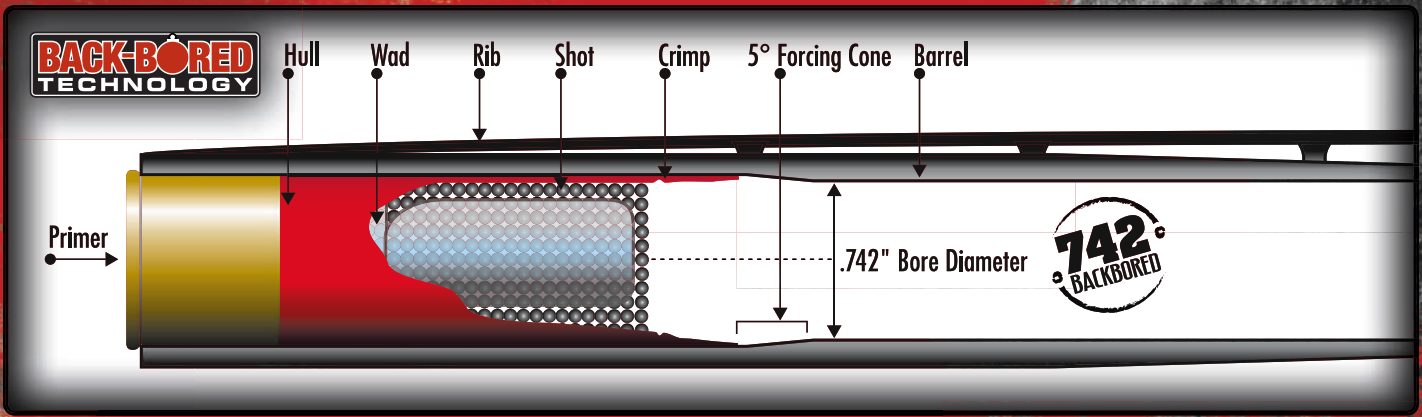

.742" BACK-BORED TECHNOLOGY is based on extensive research and testing. .742" is the ideal 12 gauge interior barrel diameter, insuring uniform, consistent patterns. Any larger and gases blow by the shot cup and reduce pellet velocity. Too tight and the pellets are deformed as they pass through the forcing cone, causing poor ballistic performance.



A HARD CHROME CHAMBER AND BORE are optimum features when using steel or tungsten shot. This makes the surfaces highly resistant to wear and gives you superior protection from rust and corrosion. All Super X^{®3} shotguns (except rifled barrels) feature a hard-chromed bore and chamber.



LOAD DIVERSITY means from light factory target shells to heavy waterfowl and turkey loads, the Super X^{®3} shoots them all reliably. 3" models fire everything from light, 1 1/2 oz., 2 3/4" target loads to 3" magnums, while 3 1/2" guns handle everything from 1 1/2 oz., 2 3/4" field loads up to heavy 3 1/2" magnums.



From the duck blind to the firing line, the **INVECTOR-PLUS™ CHOKE TUBE SYSTEM** is the world's favorite. The Super X^{®3} comes with either extended Signature or flush-mounted tubes, depending on the model. Additional tubes are available at your local Winchester Repeating Arms[®] dealer.

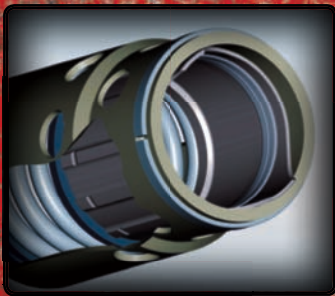

The **ACTIVE VALVE SYSTEM** automatically self-adjusts, allocating the exact gas pressure necessary to fire a wide range of loads — critical for any autoloader used in real life hunting or target shooting. When firing the heaviest magnum loads in 3 1/2" models, gases vent upward and a portion of them are vented forward out the Quadra-Vent™ ports in the forearm to help regulate bolt speed. 3" and 3 1/2" models will fire light, 1 1/2 oz., 2 3/4" target loads.

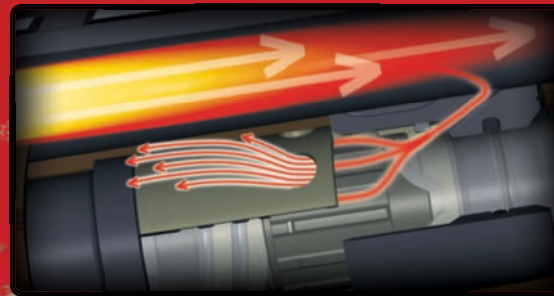

Excess gases from heavy loads are channeled through the forward **QUADRA-VENT™** ports for cleaner and more reliable operation.



The **AMBIDEXTROUS SAFETY** button on the Super X^{®3} is located at the rear of the trigger guard and is easily reversible for both right- or left-handed shooters.



The **DROP-OUT TRIGGER GROUP** is easy to remove for cleaning.

RNT-V

Winchester Repeating Arms is a **PROUD SPONSOR** of the television show RNT-V. If you want to stay on top of your game in expert waterfowl calling and shooting, tune in for timely tactics. Check your local listings for show times.

WANNA SEE FAST?
Scan this ▶



SUPER X[®]3 FAST. FASTER. AND FASTEST.

The Winchester[®] Super X3 Sporting gives you the kind of speed you need to take clay targets traveling 55 mph — faster than flushed birds fly. The Super X3 Sporting weighs a tad over 7 pounds, giving you a well-balanced, more controlled swing. Simply move the comb up or down, left or right, custom fitting your Super X3 Sporting and putting you on target to take home the trophy.



SX3[®]

| Item Number | Gauge | Barrel Length | Chamber | Magazine Capacity | Choke Tubes Included | Overall Length | Length of Pull | Drop at Comb | Drop at Heel | Nominal Wt. (lbs.) | Sugg. Retail |
|---------------------------------------|-------|---------------|---------|-------------------|----------------------|----------------|----------------|--------------|--------------|--------------------|--------------|
| SX3 SPORTING (ADJUSTABLE COMB) | | | | | | | | | | | |
| 511115392 | 12 | 28" | 2¾" | 4* | LF, IM, M, IC, SK | 49¼" | 14½" | 1½"† | 1¾"† | 7½ | \$1,699.99 |
| 511115393 | 12 | 30" | 2¾" | 4* | LF, IM, M, IC, SK | 51¼" | 14½" | 1½"† | 1¾"† | 7½ | 1,699.99 |
| 511115394 | 12 | 32" | 2¾" | 4* | LF, IM, M, IC, SK | 53¼" | 14½" | 1½"† | 1¾"† | 7½ | 1,699.99 |

*Total Capacity (Includes one shell in the chamber): 2¾" = 5 †Adjustable comb stock dimensions are measured with comb in the lowest position.



The Super X³ Sporting comes with a durable, fitted ABS hard case embossed with the Winchester[®] logo.

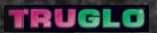

T-Wrench, LF, IM, M, IC, SK

SPORTING

- **SATIN OIL FINISH GRADE II / III WALNUT STOCK WITH CUT CHECKERING** improves grip and looks elegant
- **FULLY ADJUSTABLE COMB** allows perfect stock fit to your personal dimensions
- **NICKEL PLATED BOLT, CARRIER, SLIDE AND COCKING HANDLE** are extremely durable and easy to keep clean
- **.742" BACK-BORED BARREL** reduces recoil and provides ideal ballistic performance
- **2¾" CHROME PLATED CHAMBER AND BORE** stand up to heavy use and corrosion
- **TRUGLO[®] TRU-BEAD[®] FIBER-OPTIC FRONT SIGHT** with interchangeable light pipes and white mid-bead offers true, precise sight picture in any light
- **PORTED BARREL** reduces muzzle jump and helps tame recoil
- **EXTENDED SIGNATURE INVECTOR-PLUS[™] CHOKE TUBES** offer uniform, reliable patterns
- **CUSTOM ACTIVE VALVE SYSTEM DESIGNED FOR THE SUPER X³ SPORTING** cycles the lightest to the heaviest 2¾" loads while reducing felt recoil
- **PACHMAYR[®] DECELERATOR[®] RECOIL PAD** provides optimal protection against felt recoil
- **AMBIDEXTROUS SAFETY** is easily reversible
- **DROP-OUT TRIGGER** can be removed for cleaning

12 SHOTS IN
1.442
SECONDS



SUPER X[®] 3 FIT TO BE TRIED.

All Super X3 autoloading shotguns have the advanced technical features that make them fast, reliable, comfortable to shoot and easy to clean. The Super X3 Black Field is tailor-made for the most rugged hunting conditions. Check out the new Super X3 Black Field Compact. Now youth, ladies and shooters with smaller frames can be out in the field or on the range with a high-quality shotgun that fits them right.



12 SHOTS IN
1.442
SECONDS

SX3[®]



| | Item Number | Gauge | Barrel Length | Chamber | Magazine Capacity | Choke Tubes Included | Overall Length | Length of Pull | Drop at Comb | Drop at Heel | Nominal Wt. (lbs.) | Sugg. Retail |
|--------------------------------|-------------|-------|---------------|---------|-------------------|----------------------|----------------|----------------|--------------|--------------|--------------------|--------------|
| SX3 BLACK FIELD | | | | | | | | | | | | |
| NEW | 511144391 | 12 | 26" | 3" | 4* | F, M, IC | 46¾" | 14" | 1½" | 1¾" | 6¾ | \$1,069.99 |
| NEW | 511144392 | 12 | 28" | 3" | 4* | F, M, IC | 48¾" | 14" | 1½" | 1¾" | 6½ | 1,069.99 |
| NEW | 511144691 | 20 | 26" | 3" | 4* | F, M, IC | 46¾" | 14" | 1¾" | 1¾" | 6¾ | 1,069.99 |
| NEW | 511144692 | 20 | 28" | 3" | 4* | F, M, IC | 48¾" | 14" | 1¾" | 1¾" | 6½ | 1,069.99 |
| SX3 BLACK FIELD COMPACT | | | | | | | | | | | | |
| NEW | 511146391 | 12 | 26" | 3" | 4* | F, M, IC | 45¾" | 13" | 1½" | 1¾" | 6¾ | \$1,069.99 |
| NEW | 511146392 | 12 | 28" | 3" | 4* | F, M, IC | 47¾" | 13" | 1½" | 1¾" | 6½ | 1,069.99 |
| NEW | 511146691 | 20 | 26" | 3" | 4* | F, M, IC | 45¾" | 13" | 1¾" | 1¾" | 6¾ | 1,069.99 |
| NEW | 511146692 | 20 | 28" | 3" | 4* | F, M, IC | 47¾" | 13" | 1¾" | 1¾" | 6½ | 1,069.99 |

*Total Capacity (Includes one shell in the chamber): 2¾" = 5, 3" = 4



F, M, IC



BLACK FIELD

NEW

- SATIN OIL FINISH WALNUT STOCK WITH CLASSIC CUT CHECKERING improves grip and looks elegant
- MATTE BLACK RECEIVER is strong, lightweight aluminum alloy, no glare, easy carrying
- 742" BACK-BORED TECHNOLOGY provides optimum shot patterns
- TRADITIONAL BRASS FRONT SIGHT BEAD for great visibility in all conditions
- 3" CHROME PLATED CHAMBER AND BORE stand up to heavy use and corrosion
- INVECTOR-PLUS™ CHOKE TUBES offer consistent, reliable patterns
- ACTIVE VALVE SYSTEM cycles a wide variety of loads while reducing felt recoil
- PACHMAYR® DECELERATOR® RECOIL PAD provides optimal protection against felt recoil
- AMBIDEXTROUS SAFETY is easily reversible
- DROP-OUT TRIGGER can be removed for cleaning



F, M, IC



BLACK FIELD COMPACT

NEW

- SATIN OIL FINISH WALNUT STOCK WITH CLASSIC CUT CHECKERING improves grip and looks elegant
- MATTE BLACK RECEIVER is strong, lightweight aluminum alloy, no glare, easy carrying
- .742" BACK-BORED TECHNOLOGY provides optimum shot patterns
- TRADITIONAL BRASS FRONT SIGHT BEAD for great visibility in all conditions
- 3" CHROME PLATED CHAMBER AND BORE stand up to heavy use and corrosion
- INVECTOR-PLUS™ CHOKE TUBES offer consistent, reliable patterns
- ACTIVE VALVE SYSTEM cycles a wide variety of loads while reducing felt recoil
- PACHMAYR® DECELERATOR® RECOIL PAD provides optimal protection against felt recoil
- DIMENSIONS ARE TRIMMED FOR SMALLER-FRAME SHOOTERS AND HUNTERS so they can have a gun that fits them right
- AMBIDEXTROUS SAFETY is easily reversible
- DROP-OUT TRIGGER can be removed for cleaning

SUPER X[®]3 GET READY FOR THE OPENER.

Shotguns look great in black, and no faster swinging, faster cycling, better looking autoloader can be found than the Super X3 Black Shadow[®]. Its tough composite stock is ready for days full of rain-soaked mud, squalls, corn fields or dusty hedgerows. Deer hunters using shotguns with slugs will love the Cantilever Buck. Attach a conventional scope, an electronic red dot sight or use the open sights for a natural, perfect sight picture.

RNT-V

"As hunters, we live by the whims of Mother Nature; there are no absolutes. As a duck hunter, I rely on the things I can control such as lifelike decoys, a good duck call, a warm pair of waders, shells and a trusty shotgun. I know that when it's time to get things done, every time I punch the safety and pull the trigger, my Super X[®]3 is gonna work."

— JIM RONQUEST
 Producer RNT-V
 World Champion Duck Caller
 Co-Host of RNT-V

| | Item Number | Gauge | Barrel Length | Chamber | Magazine Capacity | Choke Tubes Included | Overall Length | Length of Pull | Drop at Comb | Drop at Heel | Nominal Wt. (lbs.) | Sugg. Retail |
|----------------------------|-------------|-------|---------------|---------|-------------------|----------------------|----------------|----------------|--------------|--------------|--------------------|--------------|
| SX3 BLACK SHADOW | | | | | | | | | | | | |
| NEW | 511123291 | 12 | 26" | 3½" | 4* | F, M, IC | 47" | 14¼" | 1¾" | 2" | 7 | \$1,069.99 |
| NEW | 511123292 | 12 | 28" | 3½" | 4* | F, M, IC | 49" | 14¼" | 1¾" | 2" | 7¼ | 1,069.99 |
| NEW | 511123391 | 12 | 26" | 3" | 4* | F, M, IC | 47" | 14¼" | 1¾" | 2" | 7 | 999.99 |
| NEW | 511123392 | 12 | 28" | 3" | 4* | F, M, IC | 49" | 14¼" | 1¾" | 2" | 7¼ | 999.99 |
| NEW | 511123691 | 20 | 26" | 3" | 4* | F, M, IC | 47" | 14¼" | 1¾" | 2" | 6½ | 999.99 |
| NEW | 511123692 | 20 | 28" | 3" | 4* | F, M, IC | 49" | 14¼" | 1¾" | 2" | 6¾ | 999.99 |
| SX3 CANTILEVER BUCK | | | | | | | | | | | | |
| NEW | 511147340 | 12 | 22" | 3" | 4† | N/A | 43" | 14¼" | 1¾" | 2" | 7¼ | \$1,149.99 |
| NEW | 511147640 | 20 | 22" | 3" | 4† | N/A | 43" | 14¼" | 1¾" | 2" | 7½ | 1,149.99 |

*Total Capacity (Includes one shell in the chamber): 2¾" = 5, 3" = 4, 3½" = 4 †Magazine capacity depends on shell length. Some slugs are longer than standard 2¾" shot shells.



BLACK SHADOW® **NEW**

- **MATTE BLACK SYNTHETIC STOCK WITH TEXTURED GRIPPING SURFACE** gives your hands a sure, non-slip grip and a rugged, non-glare finish
- **.742" BACK-BORED TECHNOLOGY BARREL** reduces recoil and provides ideal shot performance with less shot deformation
- **INVECTOR-PLUS™ CHOKE TUBE SYSTEM** offers uniform, reliable patterns
- **HARD CHROME CHAMBER AND BORE** make surfaces highly resistant to wear and corrosion
- **TRADITIONAL BRASS BEAD FRONT SIGHT** for great visibility in all conditions
- **SELF-ADJUSTING ACTIVE VALVE SYSTEM** cycles a wide variety of loads from factory target to heavy waterfowl and turkey loads while reducing felt recoil
- **QUADRA-VENT™ PORTS** vent excess gases for cleaner operation
- **12 SHOTS IN JUST 1.442 SECONDS** for multiple shots when needed
- **DROP-OUT TRIGGER** easily removed for cleaning
- **AMBIDEXTROUS SAFETY** is easily reversible
- **CAST/DROP SHIMS AND LENGTH OF PULL SPACERS** allow adjustments for perfect fit
- **INFLEX TECHNOLOGY RECOIL PAD** channels felt recoil down and away from your cheek

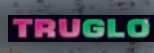

CANTILEVER BUCK® **NEW**

- **MATTE BLACK SYNTHETIC STOCK WITH TEXTURED GRIPPING SURFACE** gives your hands a sure, non-slip grip and a rugged, non-glare finish
- **RIFLED 22" BARREL** optimized for extreme accuracy with 2¾" and 3" sabot slugs
- **RECEIVER** is strong, lightweight aluminum alloy
- **WEAVER™ STYLE CANTILEVER RAIL DESIGN** makes it easy to attach a red dot or conventional scope
- **TRUGLO® FIBER-OPTIC FRONT SIGHT** with adjustable rear sight gathers light for fast, quick pointing
- **HARD CHROME CHAMBER AND BORE** make the surfaces highly resistant to wear and corrosion
- **DROP-OUT TRIGGER** easily removed for cleaning
- **AMBIDEXTROUS SAFETY** is easily reversible
- **INFLEX TECHNOLOGY RECOIL PAD** channels felt recoil down and away from your cheek

12 SHOTS IN
1.442
SECONDS



SUPER X[®]3 ALL-TERRAIN HUNTERS.

The Super X3 Waterfowl Hunter is well hidden in Mossy Oak[®] Duck Blind[®] camo, ready to take on wary ducks and geese. The Universal Hunter gives you a fully concealed, Mossy Oak[®] Break-Up Infinity[®] camo pattern that disappears in your blind. It's also drilled and tapped for scope mounts. Get the renowned Invector-Plus[™] choke tube system on both of these models and be ready in seconds with the proper shot pattern.

RNT-V

"Born and raised duck hunting in Stuttgart, Arkansas along with traveling around the country gathering footage for RNT-V, I have had the opportunity to shoot several different shotguns. For me, the Winchester Super X[®]3 is hands down the best fitting, best handling, most reliable shotgun I have ever shot. The Super X3 has done everything I have ever asked a shotgun to do — every time I pull the trigger."

— JOHN STEPHENS
President RNT Calls
3-time World Champion Duck Caller
Executive Producer and Co-Host of RNT-V

| | Item Number | Gauge | Barrel Length | Chamber | Magazine Capacity | Choke Tubes Included | Overall Length | Length of Pull | Drop at Comb | Drop at Heel | Nominal Wt. (lbs.) | Sugg. Retail |
|-----------------------------|-------------|-------|---------------|---------|-------------------|----------------------|----------------|----------------|--------------|--------------|--------------------|--------------|
| SX3 WATERFOWL HUNTER | | | | | | | | | | | | |
| NEW | 511150291 | 12 | 26" | 3½" | 4* | F, M, IC | 47" | 14¼" | 1¾" | 2" | 7 | \$1,199.99 |
| NEW | 511150292 | 12 | 28" | 3½" | 4* | F, M, IC | 49" | 14¼" | 1¾" | 2" | 7½ | 1,199.99 |
| NEW | 511150391 | 12 | 26" | 3" | 4* | F, M, IC | 47" | 14¼" | 1¾" | 2" | 7 | 1,139.99 |
| NEW | 511150392 | 12 | 28" | 3" | 4* | F, M, IC | 49" | 14¼" | 1¾" | 2" | 7½ | 1,139.99 |
| NEW | 511150691 | 20 | 26" | 3" | 4* | F, M, IC | 47" | 14¼" | 1¾" | 2" | 6½ | 1,139.99 |
| NEW | 511150692 | 20 | 28" | 3" | 4* | F, M, IC | 49" | 14¼" | 1¾" | 2" | 6¾ | 1,139.99 |
| SX3 UNIVERSAL HUNTER | | | | | | | | | | | | |
| NEW | 511148291 | 12 | 26" | 3½" | 4* | F, M, IC | 47" | 14¼" | 1¾" | 2" | 7 | \$1,229.99 |
| NEW | 511148292 | 12 | 28" | 3½" | 4* | F, M, IC | 49" | 14¼" | 1¾" | 2" | 7½ | 1,229.99 |
| NEW | 511148691 | 20 | 26" | 3" | 4* | F, M, IC | 47" | 14¼" | 1¾" | 2" | 6½ | 1,159.99 |
| NEW | 511148692 | 20 | 28" | 3" | 4* | F, M, IC | 49" | 14¼" | 1¾" | 2" | 6¾ | 1,159.99 |

*Total Capacity (Includes one shell in the chamber): 2¾" = 5, 3" = 4, 3½" = 4



F, M, IC

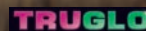

WATERFOWL HUNTER **NEW**

- **SYNTHETIC STOCK WITH TEXTURED GRIPPING SURFACES** dipped in Mossy Oak® Duck Blind® give your hands a sure, non-slip grip and non-glare finish for wary waterfowl
- **.742" BACK-BORED TECHNOLOGY BARREL** reduces recoil and provides ideal shot performance with less shot deformation
- **INVECTOR-PLUS™ CHOKE TUBE SYSTEM** offers uniform, reliable patterns
- **HARD CHROME CHAMBER AND BORE** make surfaces highly resistant to wear and corrosion
- **TRUGLO® LONG BEAD® FIBER-OPTIC FRONT SIGHT** offers true, precise sight picture
- **LOAD DIVERSITY** shoots all shells from factory target to heavy waterfowl and turkey loads
- **QUADRA-VENT™ PORTS** vent excess gases for cleaner operation
- **12 SHOTS IN JUST 1.442 SECONDS** put you on the game faster
- **DROP-OUT TRIGGER** is easily removed for cleaning
- **AMBIDEXTROUS SAFETY** is easily reversible
- **CAST/DROP SHIMS AND LENGTH OF PULL SPACERS** allow adjustments for perfect fit, both 12 and 20 gauge



F, M, IC

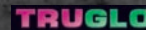

UNIVERSAL HUNTER **NEW**

- **SYNTHETIC STOCK WITH TEXTURED GRIPPING SURFACES** dipped in Mossy Oak® Break-Up Infinity® give your hands a sure, non-slip grip and non-glare finish
- **.742" BACK-BORED TECHNOLOGY BARREL** reduces recoil and provides ideal shot performance with less shot deformation
- **INVECTOR-PLUS™ CHOKE TUBE SYSTEM** offers uniform, reliable patterns
- **HARD CHROME CHAMBER AND BORE** make surfaces highly resistant to wear and corrosion
- **TRUGLO® LONG BEAD® FIBER-OPTIC FRONT SIGHT** offers true, precise sight picture
- **LOAD DIVERSITY** shoots all shells from factory target to heavy waterfowl and turkey loads
- **12 SHOTS IN JUST 1.442 SECONDS** put you on the game faster
- **DROP-OUT TRIGGER** is easily removed for cleaning
- **AMBIDEXTROUS SAFETY** is easily reversible
- **CAST/DROP SHIMS AND LENGTH OF PULL SPACERS** allow adjustments for perfect fit
- **DRILLED AND TAPPED RECEIVER** for mounting your favorite scope

12 SHOTS IN
1.442
SECONDS

SXB®

SUPER X[®]3 PASS THE GRAVY.

Don't take an inferior, unreliable shotgun after the largest and smartest game bird in the country. The Winchester[®] Super X3 NWTF[®] Cantilever Turkey with its 24" barrel and 3½" chamber means serious business for Mr. Tom. The Invector-Plus™ Extra-Full turkey choke tube funnels heavy shot right where you need it. Gas-operation tames recoil from heavy loads. All of these great features will help you bring home a memorable trophy.



SXB[®]



EXTRA-FULL TURKEY CHOKE TUBE

A tight, dense pattern of heavy shot is critical for taking turkeys. You get an Invector-Plus™ Extra-Full Turkey choke tube standard with the Super X[®]3 NWTF[®] Cantilever Turkey. The knurled band makes it easy to install or remove and the camo band won't give you away to a sharp-eyed tom.

12 SHOTS IN
1.442
SECONDS



Made by F.H. Blackburner and Son, Inc., Winchester, MA
Winchester is a registered trademark of F.H. Blackburner and Son, Inc.



NEW

NWTF[®] CANTILEVER TURKEY



- **SYNTHETIC STOCK WITH TEXTURED GRIPPING SURFACE** dipped in Mossy Oak[®] Break-Up Infinity[®] gives your hands a sure, non-slip grip and non-glare finish for wary toms
- **.742" BACK-BORED TECHNOLOGY** provides optimum shot patterns and softens recoil
- **INVECTOR-PLUS™ EXTRA FULL TURKEY CHOKE TUBE** with Mossy Oak[®] Break-Up Infinity[®] band gives you the optimum pattern
- **24" BARREL** is easy to swing in tight brush
- **TRUGLO[®] FIBER-OPTIC FRONT SIGHT WITH ADJUSTABLE REAR SIGHT** gathers light for fast, quick pointing
- **WEAVER™ STYLE CANTILEVER RAIL DESIGN** makes it easy to attach a red dot or conventional scope
- **QUADRA-VENT™ PORTS** vent excess gases for cleaner operation
- **12 SHOTS IN JUST 1.442 SECONDS** for fast, multiple shots when needed
- **DROP-OUT TRIGGER** is easily removed for cleaning
- **AMBIDEXTROUS SAFETY** is easily reversible
- **CAST/DROP SHIMS AND LENGTH OF PULL SPACERS** allow adjustments for perfect fit
- **INFLEX TECHNOLOGY RECOIL PAD** channels felt recoil down and away from your cheek

| | Item Number | Gauge | Barrel Length | Chamber | Magazine Capacity | Choke Tubes Included | Overall Length | Length of Pull | Drop at Comb | Drop at Heel | Nominal Wt. (lbs.) | Sugg. Retail |
|-----------------------------------|-------------|-------|---------------|---------|-------------------|----------------------|----------------|----------------|--------------|--------------|--------------------|--------------|
| SX3 NWTF CANTILEVER TURKEY | | | | | | | | | | | | |
| NEW | 511149290 | 12 | 24" | 3½" | 4* | T | 45" | 14¼" | 1¾" | 2" | 7½ | \$1,199.99 |
| NEW | 511149690 | 20 | 24" | 3" | 4* | T | 45" | 14¼" | 1¾" | 2" | 7⅞ | 1,139.99 |

*Total Capacity (Includes one shell in the chamber): 2¾" = 5, 3" = 4, 3½" = 4

SUPER X[®] PUMP

FASTEST
PUMP ACTION
EVER.

Nothing sounds more exciting than the sure, fast cycling of a reliable pump shotgun. The Winchester[®] Super X Pump is the perfect choice for pump shotgun lovers because of its rocket-like inertia-assisted slide action. Three shots can be delivered in just a half second, taking first place for speed and smooth cycling ahead of all other pump shotguns. Your buddies may think it's an autoloader, especially when you're faster on follow-up shots.

NOW IN
3 1/2"

44

WINCHESTERGUNS.COM

WANNA
SEE
FAST?
Scan this



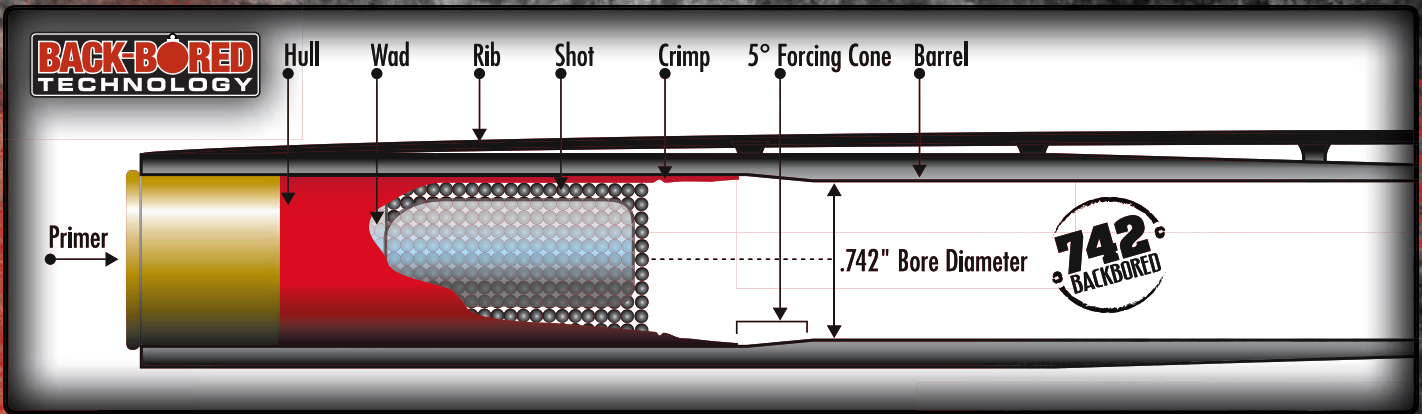

.742" BACK-BORED TECHNOLOGY is based on extensive research and testing showing that when it comes to back-boring, .742" is the ideal 12 gauge interior barrel diameter, ensuring tight, consistent patterns. Any larger and gases blow by the shot cup and reduce pellet velocity. Too tight and the pellets are deformed as they pass through the forcing cone, causing poor ballistic performance.



HARD CHROME CHAMBER AND BORE are optimum features when using steel or tungsten shot. This makes the surfaces highly resistant to wear and gives you superior protection from rust and corrosion. All Super X[®] Pump shotguns feature a hard-chromed bore and chamber.

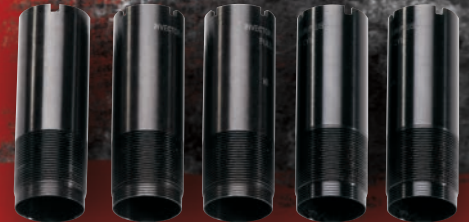

From the duck blind to the firing line, the **INVECTOR-PLUS™ CHOKE TUBE SYSTEM** is the world's favorite. The Super X[®] Pump comes with full, modified and improved cylinder flush-mounted tubes so your gun is ready to shoot right out of the box. Additional tubes are available at your local Winchester Repeating Arms[®] dealer.

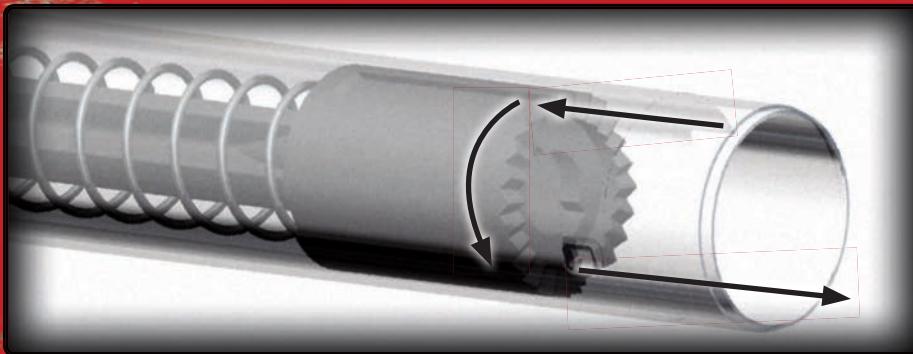

SPEED-PLUG SYSTEM lets you remove the three-shot adapter by removing the magazine cap, pushing on the spring retainer holding the spring in place and removing the adapter. It's trouble-free. In seconds you can remove or install the adapter without tools.

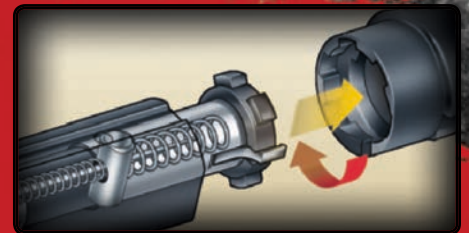

Four massive **ROTARY BOLT LUGS** provide support, strength and solid lockup in the receiver of the lightning-fast Super X[®] Pump. Under recoil, the mass of your body slows the rearward travel of the shotgun, while the inertia of the bolt, slide and forearm continue cycling the action to help you get a head start on your next shot. Dual steel action guide bars channel and eliminate twisting, binding, wasted time and energy when cycling the action.



The **CROSSBOLT SAFETY** button on the Super X[®] Pump is located on the front of the trigger guard for easy access, even when wearing gloves.

DROP-OUT TRIGGER GROUP removes with one pin and allows you to drop out the complete trigger system for cleaning and inspection. Nothing could be more simple for keeping your Super X[®] Pump in excellent working condition.



Recoil absorption is critical on any shotgun, and the new Super X[®] Pump has the best pad made. Rib structures inside the **INFLEX TECHNOLOGY RECOIL PAD** help direct and channel the recoil impulse, moving the comb down and away from your cheek. A hard heel insert on the pad makes mounting the Super X Pump snag free.

Better than conventional bluing, **BLACK CHROME FINISHES** stand up to years of wear and last longer. Parts and surfaces are easier to clean and stay cleaner.

SUPER X[®] PUMP

SPEED PUMP
ACTION.

If you're looking for a pump-action shotgun that's fast and dependable, get the speed you need from the Super X Pump. No pump-actuated system can match the fast, dependable, inertia-assisted rotary bolt. It delivers three shots in a half-second. Pick one up, shoulder it, shoot it and you'll agree it's a solid handling shotgun with speed to spare.

NOW IN
3 1/2"

SXP[®]

46

WINCHESTERGUNS.COM



HARD CHROME CHAMBER AND BORE are optimum features when using steel or tungsten shot. This makes the surfaces highly resistant to wear and gives you superior protection from rust and corrosion. All Super X® Pump shotguns feature a hard-chromed bore and chamber.

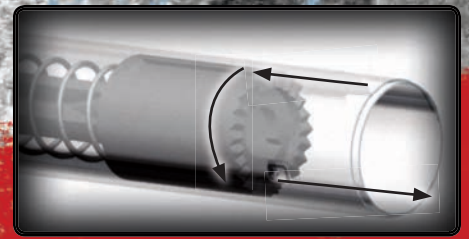

SPEED-PLUG SYSTEM lets you remove the three-shot adapter by removing the magazine cap, pushing on the spring retainer holding the spring in place and removing the adapter. It's trouble-free. In seconds you can remove or install the adapter without tools.

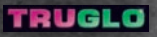
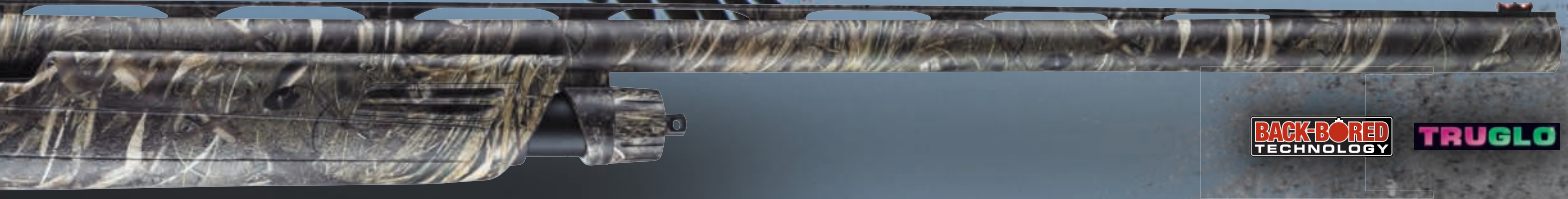

F, M, IC

WATERFOWL HUNTER

- **SYNTHETIC STOCK WITH TEXTURED GRIPPING SURFACES** dipped in Mossy Oak® Duck Blind® give your hands a sure, non-slip grip and non-glare finish for wary waterfowl
- **.742" BACK-BORED TECHNOLOGY BARREL** reduces recoil and provides ideal shot performance with less shot deformation
- **NEW 3½" CHAMBER** gives you the advantage to reach out for heavy, long-range waterfowl
- **INVECTOR-PLUS™ CHOKE TUBE SYSTEM** offers uniform, reliable patterns
- **HARD CHROME CHAMBER AND BORE** make surfaces highly resistant to wear, more durable and corrosion resistant
- **BLACK CHROME PROTECTION** on bolt and other components is better than bluing
- **TRUGLO® LONG BEAD® FIBER-OPTIC FRONT SIGHT** offers true, precise sight picture
- **3-SHOT ADAPTER WITH SPEED-PLUG SYSTEM** is easily and quickly removed
- **ROTARY BOLT** with four massive lugs provide strength, support and solid lockup
- **DROP-OUT TRIGGER GROUP** allows easy cleaning
- **CROSSBOLT SAFETY** is easily operated
- **INFLEX TECHNOLOGY RECOIL PAD** directs felt recoil down and away from your cheek



| | Item Number | Gauge | Barrel Length | Chamber | Magazine Capacity | Choke Tubes Included | Overall Length | Length of Pull | Drop at Comb | Drop at Heel | Nominal Wt. (lbs.) | Sugg. Retail |
|-----------------------------|-------------|-------|---------------|---------|-------------------|----------------------|----------------|----------------|--------------|--------------|--------------------|--------------|
| SXP WATERFOWL HUNTER | | | | | | | | | | | | |
| NEW | 512254291 | 12 | 26" | 3½" | 4* | F, M, IC | 47" | 13¾" | 1⅝" | 2" | 6⅞ | \$579.99 |
| NEW | 512254292 | 12 | 28" | 3½" | 4* | F, M, IC | 49" | 13¾" | 1⅝" | 2" | 7 | 579.99 |
| | 512254391 | 12 | 26" | 3" | 4* | F, M, IC | 46½" | 13¾" | 1⅝" | 2" | 6¾ | 529.99 |
| | 512254392 | 12 | 28" | 3" | 4* | F, M, IC | 48½" | 13¾" | 1⅝" | 2" | 6⅞ | 529.99 |

*Total Capacity (Includes one shell in the chamber): 2¾" = 5, 3" = 4, 3½" = 4

SUPER X[®] PUMP

VERSATILE,
RELIABLE,
FAST ACTION.

Lightweight, instant, center balanced and natural pointability — trademarks of a very fast pump shotgun. When sighting on racing birds or shooting targets, the super fast, Super X Pump Black Shadow[®] makes a lot of sense. The do-it-all Super X Pump Defender[™] is the perfect choice for home security, competition or camping. The six-shell total capacity, composite stock and forearm create total capability and confidence.



SXP[®]

NOW IN
3 1/2"



DEFENDER[™]

- **MATTE BLACK SYNTHETIC STOCK WITH TEXTURED GRIPPING SURFACES** gives your hands a sure, non-slip grip and non-glare finish
- **TACTICAL RIBBED FOREARM** for better grip
- **HARD CHROMED CHAMBER AND BORE** stand up to steel, tungsten, bismuth and lead loads
- **3-SHOT ADAPTER WITH THE SPEED-PLUG SYSTEM** is quickly and easily removed
- **TRADITIONAL BRASS BEAD FRONT SIGHT** for great visibility in all conditions and all directions
- **ROTARY BOLT** with four massive lugs provide strength, support and solid lockup
- **DROP-OUT TRIGGER GROUP** allows easy cleaning
- **CROSSBOLT SAFETY** is easily operated
- **BLACK CHROME PROTECTION** on bolt and other components is more durable and corrosion resistant
- **INFLEX TECHNOLOGY RECOIL PAD** directs felt recoil away from your cheek

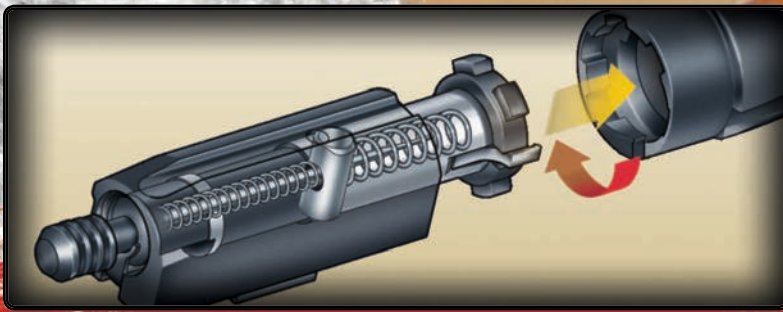

Four massive **ROTARY BOLT** lugs provide support, strength and solid lockup in the receiver of the lightning-fast Super X® Pump. Under recoil the mass of your body slows the rearward travel of the shotgun, while the inertia of the bolt, slide and forearm continue cycling the action to help you get a head start on your next shot. Dual steel action guide bars channel and eliminate twisting, binding, wasted time and energy when cycling the action.



BLACK SHADOW®

- **MATTE BLACK SYNTHETIC STOCK AND FOREARM** with textured gripping surfaces give your hands a sure, non-slip grip and non-glare finish for wary game
- **.742" BACK-BORED TECHNOLOGY** provides optimum shot patterns
- **NEW 3½" CHAMBER** gives you the advantage to reach out for heavy game
- **INVECTOR-PLUS™ CHOKE TUBE SYSTEM** offers uniform, reliable patterns
- **HARD CHROME CHAMBER AND BORE** make surfaces highly resistant to wear and corrosion
- **BLACK CHROME PROTECTION** on bolt and other components is better than bluing
- **BRASS FRONT SIGHT BEAD** offers fast, natural sight picture
- **3-SHOT ADAPTER WITH SPEED-PLUG SYSTEM** is easily and quickly removed
- **ROTARY BOLT** with four massive lugs provides strength, support and solid lockup
- **DROP-OUT TRIGGER GROUP** allows easy cleaning
- **CROSSBOLT SAFETY** is easily operated
- **INFLEX TECHNOLOGY RECOIL PAD** directs felt recoil down and away from your cheek



F, M, IC

| | Item Number | Gauge | Barrel Length | Chamber | Magazine Capacity | Choke Tubes Included | Overall Length | Length of Pull | Drop at Comb | Drop at Heel | Nominal Wt. (lbs.) | Sugg. Retail |
|-------------------------|-------------|-------|---------------|---------|-------------------|----------------------|----------------|----------------|--------------|--------------|--------------------|--------------|
| SXP BLACK SHADOW | | | | | | | | | | | | |
| NEW | 512251291 | 12 | 26" | 3½" | 4* | F, M, IC | 47" | 13¾" | 1½" | 2" | 6⅞ | \$499.99 |
| NEW | 512251292 | 12 | 28" | 3½" | 4* | F, M, IC | 49" | 13¾" | 1½" | 2" | 7 | 499.99 |
| | 512251391 | 12 | 26" | 3" | 4* | F, M, IC | 46½" | 13¾" | 1½" | 2" | 6¾ | 469.99 |
| | 512251392 | 12 | 28" | 3" | 4* | F, M, IC | 48½" | 13¾" | 1½" | 2" | 6⅞ | 469.99 |
| SXP DEFENDER | | | | | | | | | | | | |
| | 512252395 | 12 | 18" | 3" | 5* | N/A | 38½" | 13¾" | 1½" | 1½" | 6¼ | \$399.99 |

*Total Capacity (Includes one shell in the chamber): Black Shadow: 2¾" = 5, 3" = 4, 3½" = 4, Defender: 2¾" = 6, 3" = 5

SUPER X[®] PUMP

LOAD UP FOR
HEAVY BIRDS.

Now, take your tom with the fastest, 3½" pump shotgun on the market! Instant pointability and heavy magnum punch are critical features your shotgun must have when hunting wild turkeys. Taking follow-up shots may be necessary and you can do it nearly as fast as an autoloader because of the Super X Pump's inertia-assisted slide action. It delivers three shots in a mere half-second. An Inflex Technology recoil pad eases the recoil of heavy magnum loads. Don't be under-gunned when a trophy tom is within range. If you're not faster than the game, the game is over.



SXP[®]

50

WINCHESTERGUNS.COM

**NOW IN
3 1/2"**



**BACK-BORED
TECHNOLOGY**

TRUGLO

NEW TURKEY HUNTER

- **SYNTHETIC STOCK WITH TEXTURED GRIPPING SURFACES** is dipped in Mossy Oak® Break-Up Infinity® giving your hands a sure, non-slip grip and non-glare finish for wary birds
- **.742" BACK-BORED TECHNOLOGY** provides optimum shot patterns
- **NEW 3 1/2" CHAMBER** gives you the advantage to reach out for heavy, game
- **INVECTOR-PLUS™ EXTRA-FULL TURKEY CHOKE TUBE** for a tight, dense pattern
- **HARD CHROMED CHAMBER AND BORE** stand up to steel, tungsten, bismuth and lead loads
- **ROTARY BOLT** with four massive lugs provide strength, support and solid lockup
- **DROP-OUT TRIGGER GROUP** allows easy cleaning
- **CROSSBOLT SAFETY** is easily operated
- **INFLEX TECHNOLOGY RECOIL PAD** directs felt recoil down and away from your cheek
- **BLACK CHROME PROTECTION** on bolt and other components is more durable and corrosion resistant

| | Item Number | Gauge | Barrel Length | Chamber | Magazine Capacity | Choke Tubes Included | Overall Length | Length of Pull | Drop at Comb | Drop at Heel | Nominal Wt. (lbs.) | Sugg. Retail |
|--------------------------|-------------|-------|---------------|---------|-------------------|----------------------|----------------|----------------|--------------|--------------|--------------------|--------------|
| SXP TURKEY HUNTER | | | | | | | | | | | | |
| NEW | 512259290 | 12 | 24" | 3 1/2" | 4* | T | 45" | 13 3/4" | 1 1/8" | 2" | 6 1/2" | \$599.99 |

*Total Capacity (Includes one shell in the chamber): 2 3/4" = 5, 3" = 4, 3 1/2" = 4

| | Item Number | Gauge | Chamber | Barrel Length | Description | Sugg. Retail |
|--|-------------|-------|---------|---------------|--|--------------|
| SUPER X3 FIELD AND TURKEY BARRELS | | | | | | |
| | 611053271 | 12 | 3½" | 26" | Perma-Cote UT Gray, Vent Rib, w/ 1 Modified Inv+ Choke | \$519.99 |
| | 611053261 | 12 | 3½" | 28" | Perma-Cote UT Gray, Vent Rib, w/ 1 Modified Inv+ Choke | 519.99 |
| | 611054371 | 12 | 3" | 26" | Perma-Cote UT Gray, Vent Rib, w/ 1 Modified Inv+ Choke | 419.99 |
| | 611054361 | 12 | 3" | 28" | Perma-Cote UT Gray, Vent Rib, w/ 1 Modified Inv+ Choke | 419.99 |
| NEW | 611054691 | 20 | 3" | 26" | Perma-Cote UT Gray, Vent Rib, w/ 1 Modified Inv+ Choke | 419.99 |
| NEW | 611054692 | 20 | 3" | 28" | Perma-Cote UT Gray, Vent Rib, w/ 1 Modified Inv+ Choke | 419.99 |
| NEW | 611123291 | 12 | 3½" | 26" | Matte Blued, Vent Rib, w/ 1 Modified Inv+ Choke | 459.99 |
| NEW | 611123292 | 12 | 3½" | 28" | Matte Blued, Vent Rib, w/ 1 Modified Inv+ Choke | 459.99 |
| NEW | 611123391 | 12 | 3" | 26" | Matte Blued, Vent Rib, w/ 1 Modified Inv+ Choke | 399.99 |
| NEW | 611123392 | 12 | 3" | 28" | Matte Blued, Vent Rib, w/ 1 Modified Inv+ Choke | 399.99 |
| NEW | 611123691 | 20 | 3" | 26" | Matte Blued, Vent Rib, w/ 1 Modified Inv+ Choke | 399.99 |
| NEW | 611123692 | 20 | 3" | 28" | Matte Blued, Vent Rib, w/ 1 Modified Inv+ Choke | 399.99 |
| NEW | 611074271 | 12 | 3½" | 26" | MODB, Vent Rib, w/ 1 Modified Inv+ Choke | 549.99 |
| NEW | 611074261 | 12 | 3½" | 28" | MODB, Vent Rib, w/ 1 Modified Inv+ Choke | 549.99 |
| NEW | 611074691 | 20 | 3" | 26" | MODB, Vent Rib, w/ 1 Modified Inv+ Choke | 549.99 |
| NEW | 611074692 | 20 | 3" | 28" | MODB, Vent Rib, w/ 1 Modified Inv+ Choke | 549.99 |
| NEW | 611117291 | 12 | 3½" | 26" | MOINF, Vent Rib, w/ 1 Modified Inv+ Choke | 549.99 |
| NEW | 611117292 | 12 | 3½" | 28" | MOINF, Vent Rib, w/ 1 Modified Inv+ Choke | 549.99 |
| NEW | 611117691 | 20 | 3" | 26" | MOINF, Vent Rib, w/ 1 Modified Inv+ Choke | 549.99 |
| NEW | 611117692 | 20 | 3" | 28" | MOINF, Vent Rib, w/ 1 Modified Inv+ Choke | 549.99 |
| | 611053253 | 12 | 3½" | 24" | Perma-Cote UT Gray, Vent Rib, Tru-Glo Sights, w/ 1 X-Full Extended Inv+ Choke Tube | 519.99 |
| NEW | 611053653 | 20 | 3" | 24" | Perma-Cote UT Gray, Vent Rib, Tru-Glo Sights, w/ 1 X-Full Extended Inv+ Choke Tube | 549.99 |
| NEW | 611123253 | 12 | 3½" | 24" | Matte Blued, Vent Rib, Tru-Glo Sights, w/ 1 X-Full Extended Inv+ Choke Tube | 459.99 |
| NEW | 611123353 | 12 | 3" | 24" | Matte Blued, Vent Rib, Tru-Glo Sights, w/ 1 X-Full Extended Inv+ Choke Tube | 399.99 |
| NEW | 611123653 | 20 | 3" | 24" | Matte Blued, Vent Rib, Tru-Glo Sights, w/ 1 X-Full Extended Inv+ Choke Tube | 399.99 |

Do not attempt the use of 3½" chambered barrels with 3" receivers nor 3" chambers with 3½" receivers.

*To prevent damage to forearms, all Super X3 rifled cantilever barrels are delivered with a new forearm specifically designed to fit over the thicker, rifled barrel wall.

| | Item Number | Gauge | Chamber | Barrel Length | Description | Sugg. Retail |
|--------------------------------|-------------|-------|---------|---------------|---|--------------|
| SUPER X3 RIFLED BARRELS | | | | | | |
| | 611108240 | 12 | 3½" | 22" | Matte Blued, Rifled, Cantilever Scope Mount with Synthetic Forearm* | \$629.99 |
| | 611107240 | 12 | 3½" | 22" | MOBU, Rifled, Cantilever Scope Mount with Synthetic Forearm* | 699.99 |
| | 611121240 | 12 | 3½" | 22" | MOBU Infinity, Rifled, Cantilever Scope Mount with Synthetic Forearm* | 699.99 |
| | 611108340 | 12 | 3" | 22" | Matte Blued, Rifled, Cantilever Scope Mount with Synthetic Forearm* | 579.99 |
| | 611107340 | 12 | 3" | 22" | MOBU, Rifled, Cantilever Scope Mount with Synthetic Forearm* | 659.99 |
| | 611121340 | 12 | 3" | 22" | MOBU Infinity, Rifled, Cantilever Scope Mount with Synthetic Forearm* | 659.99 |
| NEW | 611062640 | 20 | 3" | 22" | Matte Blued, Rifled, Cantilever Scope Mount | 539.99 |
| NEW | 611121640 | 20 | 3" | 22" | MOBU Infinity, Rifled, Cantilever Scope Mount | 599.99 |

| SUPER X2 FIELD AND TURKEY BARRELS | | | | | | |
|--|-----------|----|-----|-----|---|----------|
| | 611063253 | 12 | 3½" | 24" | Matte Blued, Vent Rib, Tru-Glo Sights, w/ 1 X-Full Extended Inv+ Choke Tube | \$499.99 |
| | 611064350 | 12 | 3" | 26" | Gloss Blued, Vent Rib, w/ 1 Inv+ Choke | 379.99 |
| | 611064346 | 12 | 3" | 28" | Gloss Blued, Vent Rib, w/ 1 Inv+ Choke | 379.99 |

| SUPER X2 RIFLED BARREL | | | | | | |
|-------------------------------|-----------|----|-----|-----|---|----------|
| | 611101240 | 12 | 3½" | 22" | Matte Blued, Rifled, Cantilever Scope Mount | \$549.99 |

| SUPER X PUMP FIELD AND TURKEY BARRELS | | | | | | |
|--|-----------|----|-----|-----|--|----------|
| NEW | 611251291 | 12 | 3½" | 26" | Matte Blued, Vent Rib, w/ 1 Modified Inv+ Choke | \$149.99 |
| NEW | 611251292 | 12 | 3½" | 28" | Matte Blued, Vent Rib, w/ 1 Modified Inv+ Choke | 149.99 |
| NEW | 611251391 | 12 | 3" | 26" | Matte Blued, Vent Rib, w/ 1 Modified Inv+ Choke | 149.99 |
| NEW | 611251392 | 12 | 3" | 28" | Matte Blued, Vent Rib, w/ 1 Modified Inv+ Choke | 149.99 |
| NEW | 611254291 | 12 | 3½" | 26" | MODB, Vent Rib, w/ 1 Modified Inv+ Choke | 189.99 |
| NEW | 611254292 | 12 | 3½" | 28" | MODB, Vent Rib, w/ 1 Modified Inv+ Choke | 189.99 |
| NEW | 611254391 | 12 | 3" | 26" | MODB, Vent Rib, w/ 1 Modified Inv+ Choke | 179.99 |
| NEW | 611254392 | 12 | 3" | 28" | MODB, Vent Rib, w/ 1 Modified Inv+ Choke | 179.99 |
| NEW | 611251253 | 12 | 3½" | 24" | Matte Blued, Vent Rib, w/ 1 X-Full Extended Inv+ Choke | 159.99 |
| NEW | 611251353 | 12 | 3" | 24" | Matte Blued, Vent Rib, w/ 1 X-Full Extended Inv+ Choke | 159.99 |
| NEW | 611257391 | 12 | 3" | 26" | Matte Blued, Vent Rib 5 Shot, w/ 1 Modified Inv+ Choke | 139.99 |
| NEW | 611257392 | 12 | 3" | 28" | Matte Blued, Vent Rib 5 Shot, w/ 1 Modified Inv+ Choke | 139.99 |

Do not attempt the use of 3½" chambered barrels with 3" receivers nor 3" chambers with 3½" receivers.

*To prevent damage to forearms, all Super X3 rifled cantilever barrels are delivered with a new forearm specifically designed to fit over the thicker, rifled barrel wall.



| Item Number | Gauge | Description | Diameter | Constriction | Sugg. Retail |
|---|-------|-------------------|----------|--------------|--------------|
| SIGNATURE INVECTOR-PLUS CHOKE TUBES | | | | | |
| 12 Gauge for Winchester Supreme, Select, Super X2, Super X3 and Super X Pump Shotguns | | | | | |
| 61307103 | 12 | Turkey | .660 | .082 | \$49.99 |
| 6130703 | 12 | Extra-Full Trap | .700 | .040 | 49.99 |
| 6130713 | 12 | Full | .705 | .035 | 49.99 |
| 6130723 | 12 | Light Full | .710 | .030 | 49.99 |
| 6130733 | 12 | Improved Modified | .715 | .025 | 49.99 |
| 6130743 | 12 | Modified | .720 | .020 | 49.99 |
| 6130753 | 12 | Light Modified | .725 | .015 | 49.99 |
| 6130763 | 12 | Improved Cylinder | .730 | .010 | 49.99 |
| 6130773 | 12 | Skeet | .735 | .005 | 49.99 |
| 6130783 | 12 | Cylinder | .740 | .000 | 49.99 |
| 6130793 | 12 | Spreader | Rifled | — | 69.99 |

| Item Number | Gauge | Description | Diameter | Constriction | Sugg. Retail |
|--|-------|-------------------|----------|--------------|--------------|
| INVECTOR-PLUS CHOKES | | | | | |
| 12 Gauge & 20 Gauge for Winchester Supreme, Select, Super X2, Super X3 and Super X Pump Shotguns | | | | | |
| 613061 | 20 | Full | .606 | .024 | \$29.99 |
| 613062 | 20 | Improved Modified | .612 | .018 | 29.99 |
| 613063 | 20 | Modified | .615 | .015 | 29.99 |
| 613064 | 20 | Improved Cylinder | .621 | .009 | 29.99 |
| 613065 | 20 | Skeet | .624 | .006 | 29.99 |
| 613066 | 20 | Cylinder | .630 | .000 | 29.99 |
| 613050 | 12 | Extra-Full | .700 | .040 | 29.99 |
| 613051 | 12 | Full | .705 | .035 | 29.99 |
| 613052 | 12 | Improved Modified | .715 | .025 | 29.99 |
| 613053 | 12 | Modified | .720 | .020 | 29.99 |
| 613054 | 12 | Improved Cylinder | .730 | .010 | 29.99 |
| 613055 | 12 | Skeet | .735 | .005 | 29.99 |
| 613056 | 12 | Cylinder | .740 | .000 | 29.99 |
| 6130043 | 12 | T-Wrench | — | — | 19.99 |

| Item Number | Gauge | Description | Diameter | Constriction | Sugg. Retail |
|---|-------|-------------------|----------|--------------|--------------|
| STANDARD INVECTOR CHOKES | | | | | |
| 12 Gauge for Winchester Super X2 Practical Models | | | | | |
| 6130303 | 12 | Full | .690 | .035 | \$24.99 |
| 6130313 | 12 | Improved Modified | .700 | .025 | 24.99 |
| 6130323 | 12 | Modified | .705 | .020 | 24.99 |
| 6130333 | 12 | Improved Cylinder | .715 | .010 | 24.99 |
| 6130343 | 12 | Skeet | .720 | .005 | 24.99 |
| 6130353 | 12 | Cylinder | .725 | .000 | 24.99 |
| 6130033 | 12 | T-Wrench | — | — | 19.99 |

WINCHESTER® CHOKE TUBES

Winchester Signature choke tubes are unsurpassed in the shotgun industry. In collaboration with Briley® one of the most renowned makers of choke tubes in the world, the Invector-Plus™ and Standard Invector™ tubes are carefully machined from the best materials and calibrated to the strictest tolerances to deliver shot patterns exceeding your highest expectations. Installing these tubes in your barrel insures that you are getting optimum patterning for the most challenging of wild game and the most difficult presentations in clay target shooting.



HINGED FLOORPLATE MAGAZINE



DETACHABLE FLOORPLATE MAGAZINE



All Winchester® firearms are shipped with a free locking device to assist in the safe storage of firearms. (Not shown actual size.)



CUSTOMER SERVICE FOR WINCHESTER® FIREARMS

You can expect the same great Customer Service you've become accustomed to over the years. Expert gunsmiths can help you with the most technical problems and repairs to your firearms. There are many Authorized Repair Centers (ARC) throughout the country with gun repair professionals who know your firearm inside and out. If you need service on current models, as well as older Model 70, Model 94, Model 9422 or Model 1300 firearms, please contact one of the Authorized Repair Centers or our main Service Center in Arnold, Missouri. Please call (800) 333-3288 for more information.

WINCHESTER REPEATING ARMS®

Customer Service Department
275 Winchester Avenue
Morgan, UT 84050
(800) 945-5237
(801) 876-3440

Parts and Service
3005 Arnold Tenbrook Road
Arnold, MO 63010
(800) 322-4626

FOR FIREARMS: WINCHESTERGUNS.COM

FOR AMMUNITION: WINCHESTER.COM

Owner's manuals for all Winchester® firearms in this or previous catalogs are available upon request at no charge. Owners of Winchester firearms without owner's manuals are encouraged to view one online or request one at the address below. Some models and calibers are only made periodically. Winchester Repeating Arms (WRA) reserves the right to delay, postpone or discontinue production of any Winchester firearm for any reason without notice. All specifications in this catalog are subject to change without notice. Weights, stock dimensions, wood appearance, etc., may vary slightly between individual firearms. Wood is a natural product. No two pieces are alike and variation between stocks is to be expected. WRA reserves the right to modify or change specifications without notice. WRA will make every effort to make sure this catalog is accurate at the time of printing and apologizes for any errors in photographs, descriptions and specifications.

Please note that the following models are or were manufactured in Japan: Models 1885, 1886, 1892, 1894, 1895, 63 and 52B. Super X2, Super X3 and 101 shotguns are manufactured in Belgium and assembled in Portugal. Model 70 rifles are manufactured in the USA. The following trademarks are used with permission from Olin Corporation: Winchester, the Horse and Rider design, Super X, SX2 design, Super X2, SX3 design, Super X3, SXR design, Model 1892, Select, Model 101, Model 1300, Model 94, Model 70, Model Super X Pump and the red W design. Other trademarks used in this catalog: Mossy Oak Duck Blind and Mossy Oak Break-Up Infinity are registered trademarks of Haas Outdoors. Pachmayr and Decelerator are registered trademarks of Lyman. Invector-Plus, Dura-Touch and Perma-Cote are trademarks of Browning. TRUGLO is a trademark of Truglo, Inc. Marble's is a trademark of Marble's Arms.

© Copyright, WRA, September 2011. No part of this catalog may be reproduced without the written permission of Winchester Repeating Arms. Suggested retail pricing is in U.S. dollars and approximate and subject to change without notice. If you have any questions concerning Winchester brand firearms, visit your Winchester firearms dealer or write to: Winchester Repeating Arms, 275 Winchester Ave., Morgan, UT 84050-9333. Printed in USA. GAC1109200/11260 Winchester firearms are imported by BACO, Inc. Winchester is a registered trademark of Olin Corporation.



A portion of the sale of every Winchester firearm is proudly donated to the Heritage Fund, which helps to expand the legal defense against politically motivated lawsuits against the hunting and shooting industry. Working together, the rightful tradition of firearms in America will continue.

GET YOUR HANDS ON A NEW WINCHESTER®!

Only Winchester Repeating Arms® can present such deluxe firearms as you will see here. Exquisite in every detail, the rifles are pinpoint accurate in any caliber, including the historical lever guns. This year we celebrate the 75th anniversary of the venerable Model 70®. Honoring this timeless rifle is an elegant model with deep, special engraving, fancy grade details and more. The Historical gun section features many of your favorite, nostalgic lever guns. The Super X®3, firing 12 shots in just 1.442 seconds is still the world's fastest autoloading shotgun. Also new is the Super X® Pump shotgun with a 3½" magnum chamber. It's the fastest ever, delivering three shots in a half second. Select a new Winchester and fill your hands with a great day of fun shooting.

PRSR STD
U.S. POSTAGE PAID
PERMIT 315
OGDEN, UT

Winchester Repeating Arms
275 Winchester Ave., Morgan, UT
84050-9333

We proudly support these organizations.



WINCHESTER®

REPEATING ARMS