

THE
MODEL 94™
RETURNS

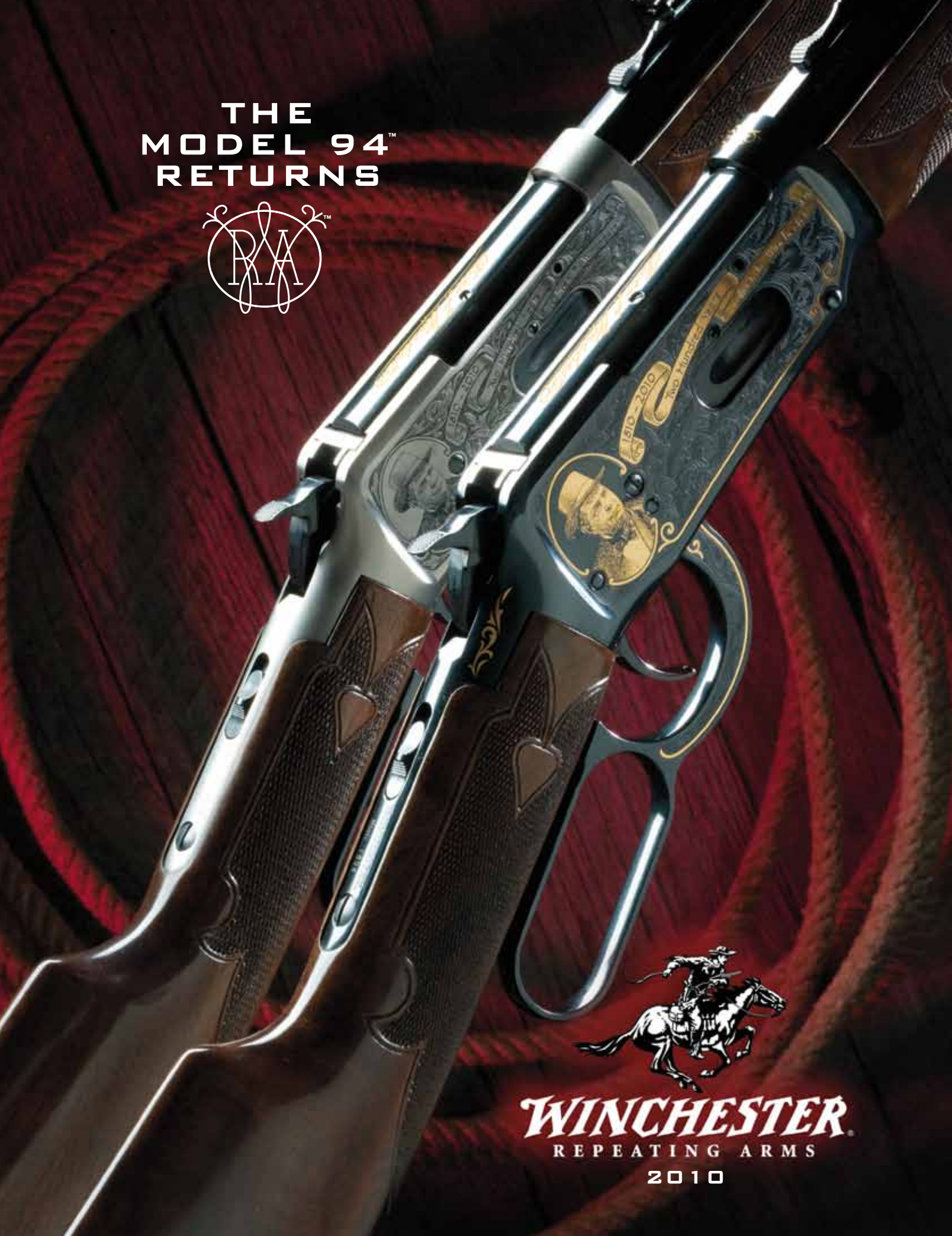

WINCHESTER
REPEATING ARMS

2010

MODEL 70™ THE RIFLE AMERICA LOVES.

LOADED.

The MODEL 70: ALWAYS THE MOST RESPECTED BOLT-ACTION RIFLE IN THE WORLD. PROUDLY, IT IS THE ALL-AMERICAN RIFLEMAN'S RIFLE, A RIFLE FOR THE AGES. IT IS THE BOLT-ACTION FOR THE FUTURE. NO OTHER RIFLE COMES AS HEAVILY LOADED WITH PROVEN FEATURES AS THE MODEL 70.

THREE-POSITION SAFETY

Convenient to operate with the thumb of the firing hand, the Model 70 safety design lifts the firing pin away from the sear. When the safety selector is in the middle position, the action can still be operated, allowing unfired cartridges to be cycled with the safety on. It is smooth to engage and easily identifies the safety status of the rifle.



BLADE-TYPE EJECTOR

A blade-type ejector allows you to have full control when ejecting a fired case. Pull the bolt back slowly and the empty case pops out gently, perfect for target shooters and varminters. Pull the bolt back smartly and the empty case clears the port with greater force.



M.O.A.™ TRIGGER SYSTEM

STAINLESS STEEL COMPONENTS

The trigger housing and all internal components of the M.O.A. Trigger are constructed of durable, corrosion-resistant stainless steel.

ZERO TAKE UP

Take up is the distance the triggerpiece travels prior to the sear moving toward release and the shooter feeling resistance. The M.O.A. Trigger System has no take up because the take up spring keeps the triggerpiece in constant contact with the actuator. Unlike competitors' designs, the unique geometry of the M.O.A. pre-loads the entire trigger system to bias-out normal manufacturing tolerances.

ZERO CREEP

Creep is the perceptible movement of the trigger prior to the release of the firing pin or striker and has a negative influence on accuracy because it causes inconsistency and uncertainty during the pull of the trigger. This contributes to jerking the trigger, thus adding to the movement of the gun during firing. The 2:1 mechanical advantage created by the trigger design's unique geometry is how creep has been virtually eliminated in the Model 70 M.O.A. Trigger.

ZERO OVERTRAVEL

Overtavel is the rearward movement of the trigger after the firing pin or striker has been released. It can actually jar the gun away from its intended point of aim and is also very distracting to the shooter. The Model 70 M.O.A. Trigger System is set at the factory to have no perceptible overtravel. Where you aim is where you shoot.

RECOIL PAD

All Model 70 rifles feature a premium Pachmayr® Decelerator® recoil pad. The ideally contoured pad's contact area offers optimal protection against felt recoil and is quick to the shoulder.



FORGED STEEL RECEIVER

The receiver of the Model 70 starts out as a block of forged steel, not as a simple casting or an extruded blank. Each forging is carefully machined to create a strong, stiff and long-lasting receiver that resists flexing and delivers top accuracy for thousands of rounds. The bottom profile of the Model 70 receiver is flat to offer more surface area for bedding. It's then bedded, front and rear with a two-part epoxy, eliminating shifts in zero and preserving pinpoint accuracy. The flat bottom contour also resists twisting inside the stock during firing which is much better than the competitors' round bottom receivers.

TARGET CROWN

Every Model 70 features a recessed target crown at the muzzle to protect the rifling from nicks, dings or other damage. The bullet is uniformly released from the barrel in the same manner on every shot for more consistent accuracy.

CLAW EXTRACTOR & CONTROLLED ROUND FEED

Controlled Round Feed Bolt. If there were a single feature responsible for the Model 70 being labeled the "Bolt-Action Rifle of the Century," it would arguably be the classic Controlled Round Feed (CRF) bolt design. The massive claw extractor smoothly slips into and secures about one-quarter of the cartridge's base, exerting full control from the very moment it leaves the magazine and enters the chamber, then hangs on tight until it's fully ejected. This time-proven design allows an unfired cartridge to be extracted even if it is not yet fully chambered.

**WALNUT STOCK**

Only a beautifully-fit, solid American walnut stock enhanced with finely cut checkering is appropriate for a rifle living up to a rich legacy of accuracy and dependability.

COLD HAMMER-FORGED, FREE-FLOATING BARREL

A critical feature of any high-powered rifle is how the barrel is made and set in the stock. Every Model 70 barrel is cold hammer-forged from a solid billet of steel, shaped by massive rotary hammers over a mandrel to create the rifling. Every barrel is then stress relieved to ensure top accuracy, even during the heat of long strings of fire.

The Model 70 barrel is free-floating in the stock so that no part of the fore-end touches the barrel, because pressure from the stock can adversely influence accuracy. You can expect 1 MOA accuracy for three-shot groups from your Model 70 using premium ammo and quality optics under suitable weather and range conditions.

INTEGRAL RECOIL LUG

The recoil lug on the Model 70 is actually forged and machined as part of the receiver. It's not a separate part that's installed between the barrel and the action during assembly. This allows the barrel to be trued in perfect alignment to the front ring of the receiver for greater accuracy. There is nothing to move or shift the barrel out of alignment, ever.

**ONE-PIECE BOTTOM METAL**

The unitized trigger guard and magazine frame of the Model 70 features solid, one-piece bottom metal floorplates, not flimsy plastic. The hinged magazine floorplate speeds unloading of the cartridges, avoiding having to cycle them through the action.

The action and trigger group are held in place by sturdy, tough hex head screws.

**BUILT IN THE USA**

The All-American Model 70 is built by American craftsmen in Columbia, South Carolina. This is the same state-of-the-art factory where the rifles and machine guns used by America's Armed Forces around the world are built. They are made to the exact ISO 9001 standard of quality that Uncle Sam insists upon for military firearms.

MODEL 70™ A LEGENDARY LUXURY RIFLE.

BIG RED.

*T*HE LEGACY OF THE LAST CENTURY IS THE LEADER OF THE NEW. THE WINCHESTER™ MODEL 70 SUPER GRADE RIFLE WAS SO NAMED IN 1937 AS AN UPGRADE FROM THE STANDARD MODEL. THE SPORTER STYLE STOCK IS TRIMMER FOR EXCELLENT HANDLING AND IDEAL BALANCE. A SHADOWLINE CHEEKPIECE QUICKLY ALIGNS YOUR EYE WITH THE SCOPE. HIGHLY POLISHED, DEEPLY BLUED STEEL AND FINELY CHECKERED FANCY GRADE WALNUT DEFINE THE INTEGRITY OF A SUPER GRADE MODEL 70 RIFLE.



MODEL™
70

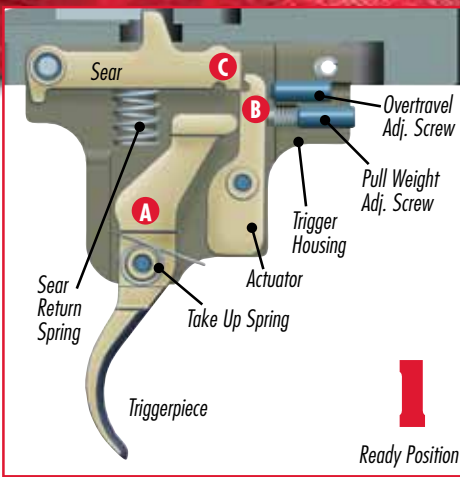

1) M.O.A. Trigger System. The Model 70 M.O.A. Trigger System works on the simple principle of the pivoting lever. Pictured left are the triggerpiece (A), actuator (B), and sear (C). The housing and all internal parts, pins and springs are precision crafted from stainless steel. The sear and actuator are Slick Shot® electroless nickel Teflon® coated for corrosion resistance and smoother operation.

2) 2:1 Mechanical Advantage. The M.O.A.'s triggerpiece (right) offers a wide, smooth face to better distribute finger pressure for a lighter, more sensitive feel. Because of the M.O.A. Trigger's geometry and 2:1 mechanical advantage, as the triggerpiece moves rearward (X), it travels only half the distance of the actuator (2X). Since this distance is greatly decreased, the perception of creep and overtravel are virtually eliminated.

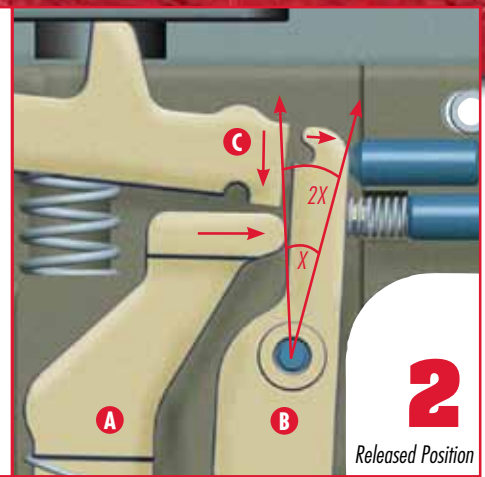

Left side view.

SUPER GRADE

From Africa's Botswana to the Brooks Range in Alaska, no other rifle has traveled so extensively in search of big game or is held in such high esteem as the Model 70. Foremost in the series is the elegant Super Grade. The warm grain and figure of the fancy grade walnut stock with finely cut checkering complement the contrasting black fore-end tip and pistol grip cap. The sleek lines of the sculpted shadowline cheekpiece flow across the stock. A blued steel stock crossbolt is tastefully engraved, adding both strength and elegance, while inletted blued steel swivel studs grace the underside. A black Pachmayr® Decelerator® pad helps soften felt recoil. The cold hammer-forged steel barrel is free floating for enhanced accuracy. The M.O.A. Trigger System puts the Super Grade under your total control. With no take up, no creep and no overtravel, it's the finest trigger ever offered and will immediately help you realize the gun's 1 MOA accuracy potential. When you're ready for super accuracy combined with super elegance, you're ready for the Model 70 Super Grade.



One-piece steel bottom metal. Adds extra rigidity to the stock and action for improved accuracy.



Shadowline cheekpiece. The Model 70 Super Grade cheekpiece is beautifully functional, placing your eye in perfect alignment behind either open sights or a scope.

MODEL 70 SUPER GRADE PRICES IN U.S. DOLLARS										
Item Number	Caliber	Magazine Capacity	Barrel Length	Overall Length	Length of Pull	Drop at Comb	Drop at Heel	Nominal Wt. (lbs.)	Rate of Twist	Sugg. Retail
SUPER GRADE • Fancy Grade Walnut Stock, No Sights										
535107264	270 WSM	3	24"	44"	13¾"	½"	½"	8	10"	\$1,189
535107255	300 WSM	3	24"	44"	13¾"	½"	½"	8	10"	1,189
535107226	270 Win.	5	24"	44½"	13¾"	½"	½"	8	10"	1,159
535107228	30-06 Sprg.	5	24"	44½"	13¾"	½"	½"	8	10"	1,159
535107233	300 Win. Mag.	3	26"	46½"	13¾"	½"	½"	8¼	10"	1,189
NEW 535107236	338 Win. Mag.	3	26"	46½"	13¾"	½"	½"	8¼	10"	1,189

- M.O.A.™ Trigger System
- Three-position safety
- Controlled Round Feeding
- Satin-finished, fancy grade walnut stock
- Hex socket action screws
- One-piece steel trigger guard and flush-mount hinged magazine floorplate

MODEL 70™ INTO AFRICA.

RED DAWN.

IT'S EVERY HUNTER'S DREAM TO VISIT AFRICA. THOSE LUCKY ENOUGH TO EXPERIENCE A ONCE-IN-A-LIFETIME HUNT TO THE DARK CONTINENT FIND IT'S CRITICAL TO BE PREPARED WITH A RELIABLE RIFLE OF THE PROPER CALIBER AND A PROVEN ACTION YOU CAN TRUST YOUR LIFE TO. IN OTHER WORDS, YOU NEED THE NEW WINCHESTER® MODEL 70 SAFARI EXPRESS BIG GAME RIFLE. THE SAFARI EXPRESS IS BUILT TO HANDLE THE PUNISHMENT FROM HEAVY, GAME-STOPPING CARTRIDGES. STILL THE SMOOTHEST ACTION IN ANY RIFLE, THE EXTERNAL CLAW EXTRACTOR CONSISTENTLY SECURES AND EJECTS EVERY CARTRIDGE.



NEW



SAFARI EXPRESS The new Model 70[™] Safari Express in a matte blued finish is the perfect choice for your once-in-a-lifetime hunt because it's built to handle the heavy cartridges necessary to take dangerous game. Important details like the Pre-'64 type claw extractor, Pachmayr[®] Decelerator[®] recoil pad, barrel band front swivel base, hooded-blade front sight and express-style rear sight make the Safari Express ideal for any African hunt. The dual recoil lugs and two steel stock reinforcing crossbolts handle the punishment from heavy magnum loads. The time-tested three-position safety has been a hallmark of the Model 70 for decades. The secure hex socket action screws won't snag on clothing, and the one-piece steel trigger guard helps maintain rigidity and provides added strength. The handsome cheekpiece positions your eye instantly and firmly on target. Flip open the flush-mounted, hinged steel magazine floorplate for fast and easy unloading. 375 H&H Mag., 416 Rem. Mag. or 458 Win. Mag. calibers are available, making the Model 70 Safari Express the finest big game rifle in the world.



Double lug strength. Adds strength to the stock and action for improved accuracy.

Deluxe cheekpiece. The Model 70[™] Safari Express cheekpiece is beautifully functional, placing your eye in perfect alignment behind either open sights or a scope.

Two cross bolts. Adds extra rigidity to the stock and action for improved accuracy. The Model 70[™] also features solid, one-piece steel bottom metal floorplates.

- **M.O.A.[™] Trigger System**
- **Three-position safety**
- **Controlled Round Feeding**
- **Satin-finished checkered walnut stock**
- **Hex socket action screws**
- **One-piece steel trigger guard and flush-mount hinged magazine floorplate**
- **Two steel crossbolts**
- **Matte blued finish**

MODEL 70 SAFARI EXPRESS PRICES IN U.S. DOLLARS (Delivery starting in 2nd quarter)												
	Item Number	Caliber	Magazine Capacity	Barrel Length	Overall Length	Length of Pull	Drop at Comb	Drop at Heel	Nominal Wt. (lbs.)	Rate of Twist	Sugg. Retail	
SAFARI EXPRESS • Grade I Walnut Stock, Open Sights												
NEW	535116161	375 H&H Mag	3	24"	44¾"	13¾"	¾"	15/16"	9	12"	\$1,279	
NEW	535116139	416 Rem. Mag.	3	24"	44¾"	13¾"	¾"	15/16"	9	14"	1,279	
NEW	535116144	458 Win. Mag.	3	24"	44¾"	13¾"	¾"	15/16"	9	14"	1,279	

MODEL 70™ THE EXTREME CONDITIONS RIFLE.

SEE RED.

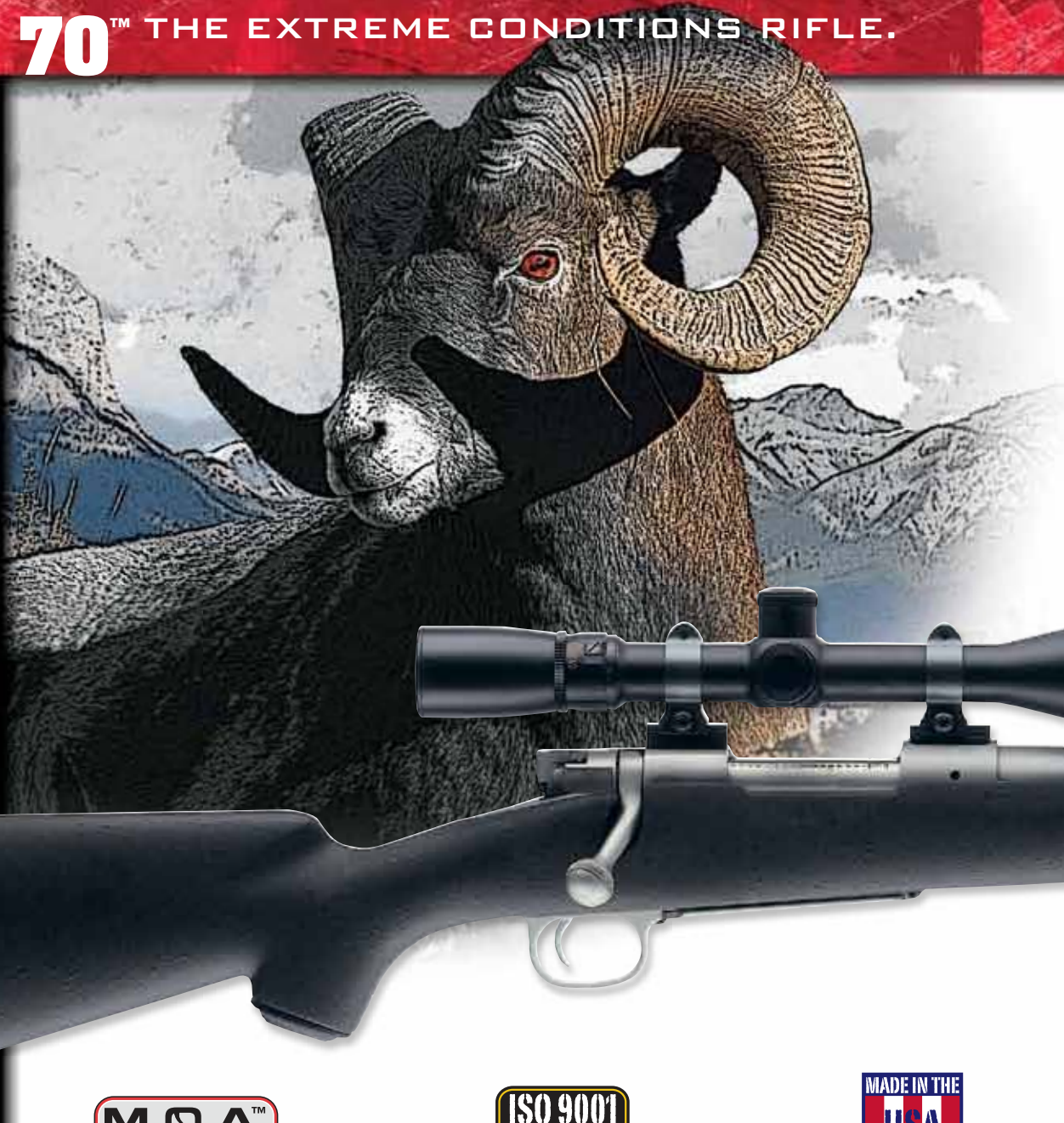

MODEL[™]
70

MODEL 70 EXTREME WEATHER SS PRICES IN U.S. DOLLARS

Item Number	Caliber	Magazine Capacity	Barrel Length	Overall Length	Length of Pull	Drop at Comb	Drop at Heel	Nominal Wt. (lbs.)	Rate of Twist	Sugg. Retail
EXTREME WEATHER SS • Bell and Carlson Synthetic Stock with Sculpted Cheekpiece, No Sights										
535110212	243 Win.	5	22"	41"	13¾"	½"	½"	6½	10"	\$1,069
535110220	308 Win.	5	22"	41"	13¾"	½"	½"	6½	12"	1,069
535110264	270 WSM	3	24"	43"	13¾"	½"	½"	6¾	10"	1,119
535110255	300 WSM	3	24"	43"	13¾"	½"	½"	6¾	10"	1,119
535110277	325 WSM	3	24"	43"	13¾"	½"	½"	6¾	10"	1,119
535110226	270 Win.	5	24"	41¾"	13¾"	½"	½"	6¾	10"	1,069
535110228	30-06 Sprg.	5	24"	41¾"	13¾"	½"	½"	6¾	10"	1,069
NEW 535110230	7mm Rem. Mag.	3	26"	43¾"	13¾"	½"	½"	7	9½"	1,119
535110233	300 Win. Mag.	3	26"	43¾"	13¾"	½"	½"	7	10"	1,119
NEW 535110236	338 Win. Mag.	3	26"	43¾"	13¾"	½"	½"	7	10"	1,119

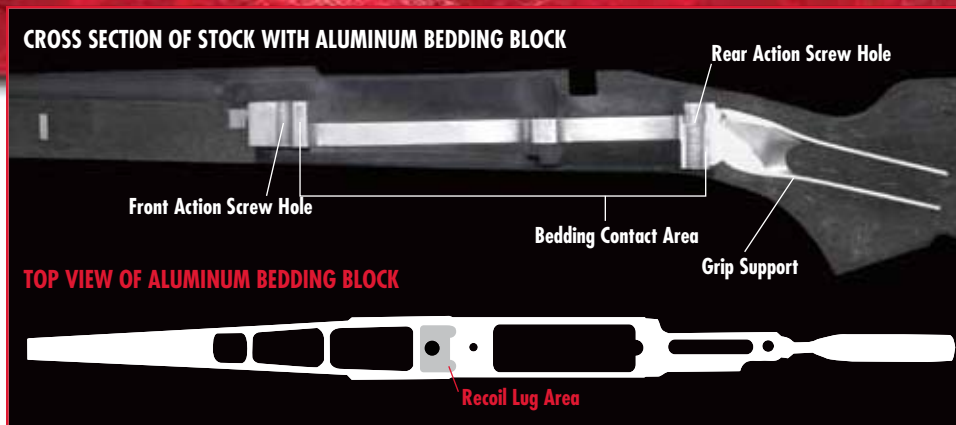

Aluminum Bedding Block. The Model 70[™] Extreme Weather SS is bedded into an alloy skeletal bedding block that's molded right into the stock during manufacturing. The precise mating of this bedding block to the lower portion of the receiver means flat-out reliability. The rifle holds a tight zero, putting the first shot and every shot that follows right where you expect, in any weather condition, season after season.

- **M.O.A.[™] Trigger System**
- **Controlled Round Feeding**
- **Three-position safety**
- **Bell and Carlson[™] premium composite stock**
- **Hex socket action screws**
- **One-piece trigger guard and hinged magazine floorplate**



EXTREME WEATHER SS Get extreme accuracy under any conditions. The Bell and Carlson[™] composite stock provides a solid feel and features trim and lightweight ergonomics. It has a textured charcoal gray matte finish for rugged good looks and improved grip in adverse conditions. The sculpted cheekpiece helps insure proper eye-to-scope alignment from any shooting position. The thick, black Pachmayr[®] Decelerator[®] pad helps take the felt recoil bite out of high performance magnum cartridges. The claw extractor offers Controlled Round Feeding so the cartridge may be easily withdrawn from the chamber at any point after it leaves the magazine. The cartridge feed lips are part of the receiver for improved reliability. The classic three-position safety offers both on safe and fire positions, plus a middle position that locks the firing pin yet still allows the bolt to be operated, providing a greater margin of safety when checking the chamber condition or unloading. The Extreme Weather SS rifle's free-floating, fluted stainless steel barrel is made in the same factory as those found on U.S. military rifles and machine guns, and features a recessed target crown to protect the rifling. With quality optics, premium ammunition and good shooting conditions, 1 MOA accuracy can be expected. Two stainless steel sling swivel studs are installed. (Scope and mounting system not included.)

*T*HE MODEL 70[™] EXTREME WEATHER SS (STAINLESS STEEL) OFFERS HUNTERS A RUGGED, ALL-WEATHER RIFLE. THE M.O.A. TRIGGER SYSTEM, PRE-'64 TYPE CONTROLLED ROUND FEED BOLT WITH CLAW EXTRACTOR AND THREE-POSITION SAFETY OFFER ABSOLUTE CONTROL OVER EVERY ROUND. THE EXTREME WEATHER SS'S TEXTURED SYNTHETIC BELL AND CARLSON[™] STOCK WITH SCULPTED CHEEKPIECE IS A HIGH-PERFORMANCE DESIGN, ENGINEERED TO MAINTAIN A RELIABLE ZERO AND PROVIDE AN IDEAL FIT FOR PERFECT EYE-TO-SCOPE ALIGNMENT IN EVERY SHOOTING POSITION. THE ONE-PIECE METAL TRIGGER GUARD AND STAINLESS STEEL HINGED MAGAZINE FLOORPLATE ADD RIGIDITY FOR IMPROVED ACCURACY. WHEN YOU FIRE THE WINCHESTER[®] MODEL 70 EXTREME WEATHER SS, YOU'LL EXPERIENCE THE ULTIMATE IN ACCURACY AND DURABILITY.

MODEL 70™ THIS DOG WILL HUNT.

WHEN OPPORTUNITIES POP UP FOR LONG-RANGE VARMINT SHOOTING, DEER HUNTING, OR FOR ANY SHOOTING SITUATION, YOU NEED A RIFLE THAT IS STABLE FROM BUTTSTOCK TO MUZZLE, HIGHLY ACCURATE AND RELIABLE. THE COYOTE LIGHT IS PERFECT FOR THE AVID HUNTER AND TARGET SHOOTER WANTING TO EXTRACT THE UTMOST ACCURACY AND PERFORMANCE FROM THEIR RIFLE.

OPEN FIRE.



MODEL™
70



Aluminum Bedding Block. Like the Model 70[®] Extreme Weather SS, the Coyote Light's receiver is bedded into an alloy skeletal bedding block molded into the stock. Mating the bedding block to the receiver equals total stability, reliability and outstanding accuracy.



COYOTE LIGHT Varmint guns are usually recognized by their heavy barrels, bipod mounting studs and long range scopes, but they are far from being equal. The Coyote Light rifle has been carefully trimmed of any unnecessary bulk but is no lightweight when it comes to performance. The matte-blued receiver and medium-heavy fluted stainless barrel mount into a skeletonized aluminum bedding block molded into the stock. Mating the bedding block to the receiver equals total stability, reliability and outstanding accuracy. The Bell and Carlson™ composite stock provides a solid feel and features trim and lightweight ergonomics. It has a textured charcoal gray matte finish for rugged good looks and improved grip for adverse conditions. The textured matte surface provides a sure, secure grip in wet conditions. Flow-through vents on the fore-end reduce weight and help cool the barrel during long strings of fire. A Pachmayr® Decelerator™ pad helps soak up recoil. Three blued sling swivel studs are installed. Available in standard short action and WSM calibers. (Scope and mounting system not included.)



- **Controlled Round Feeding**
- **Bedded action and free-floating barrel for exceptional long-range accuracy**
- **M.O.A.™ Trigger System**
- **Pachmayr® Decelerator® pad**
- **Bell & Carlson™ stock with embedded aluminum block for added strength and superb accuracy**



MODEL 70 COYOTE LIGHT PRICES IN U.S. DOLLARS										
Item Number	Caliber	Magazine Capacity	Barrel Length	Overall Length	Length of Full	Drop at Comb	Drop at Heel	Nominal Wt. (lbs.)	Rate of Twist	Sugg. Retail
COYOTE LIGHT • Bell and Carlson Synthetic Stock No Sights										
535115210	22-250 Rem.	5	24"	44"	13¾"	½"	½"	7½	14"	\$1,069
535115212	243 Win.	5	24"	44"	13¾"	½"	½"	7½	10"	1,069
535115220	308 Win.	5	24"	44"	13¾"	½"	½"	7½	12"	1,069
535115264	270 WSM	3	24"	44"	13¾"	½"	½"	7½	10"	1,119
535115255	300 WSM	3	24"	44"	13¾"	½"	½"	7½	10"	1,119
535115277	325 WSM	3	24"	44"	13¾"	½"	½"	7½	10"	1,119

MODEL 70™ ACCURACY, SHOT AFTER SHOT.

FIRE CONTROL.

*T*HE REGAL REPUTATION OF THE MODEL 70 LIVES ON IN THE ATTRACTIVE FEATHERWEIGHT AND SPORTER MODELS. BOTH HAVE BEEN FAVORITES OF HUNTERS FOR DECADES. FROM DEER TO VARMINTS, HOGS TO ANTELOPE, THESE ALL-AROUND RIFLES ARE WELL SUITED FOR ANY TYPE OF GAME.



The sculpted cheekpiece on the Model 70 Sporter.



MODEL™
70



All Model 70 rifles feature free-floating barrels.



FEATHERWEIGHT

The legendary handling and quickness of the Model 70[™] Featherweight is justly famous among hunters everywhere. The Model 70 action offers Pre-'64 style Controlled Round Feeding, a three-position safety and is highlighted by a jeweled bolt body with knurled bolt handle. Inside is the M.O.A.[™] Trigger System, the finest trigger ever offered in a bolt-action with zero take up, zero creep and zero overtravel. Like the original Featherweight, the angled comb Grade I walnut stock still features the Schnabel fore-end and satin finish with elegant cut checkering. A premium Pachmayr[®] Decelerator[®] pad helps soak up felt recoil. The Model 70 Featherweight is available in the most popular long action and short action calibers, including WSM chamberings.



SPORTER

The Sporter features a satin finish Grade I walnut stock with cut checkering on its trim fore-end and pistol grip, along with a sculpted cheekpiece for precise scope alignment to create a superbly balanced rifle that's easy to carry. The premium Pachmayr[®] Decelerator[®] recoil pad, with the ideal contact area, offers optimal protection against felt recoil while still being quick to the shoulder. Along with the Sporter's great looks and handling come a cold hammer-forged barrel and the crisp three-lever M.O.A.[™] Trigger System that let you fully exploit the 1 MOA accuracy potential of this classic hunting rifle. Available in popular long and short action calibers including WSM chamberings.

- **Satin finished checkered walnut stocks**
- **Controlled Round Feeding**
- **Bedded actions and free-floating barrels for exceptional long-range accuracy**
- **M.O.A.[™] Trigger System**
- **Pachmayr[®] Decelerator[®] pads**

MODEL 70 FEATHERWEIGHT AND SPORTER PRICES IN U.S. DOLLARS										
Item Number	Caliber	Magazine Capacity	Barrel Length	Overall Length	Length of Pull	Drop at Comb	Drop at Heel	Nominal Wt. (lbs.)	Rate of Twist	Sugg. Retail
MODEL 70 FEATHERWEIGHT • Satin Finished Grade I Walnut Stock with Angled Comb, No Sights										
535109210	22-250 Rem.	5	22"	42"	13 ³ / ₄ "	1/2"	1/2"	6 1/2	14"	\$799
535109212	243 Win.	5	22"	42"	13 ³ / ₄ "	1/2"	1/2"	6 1/2	10"	799
535109218	7mm-08 Rem.	5	22"	42"	13 ³ / ₄ "	1/2"	1/2"	6 1/2	9 1/2"	799
535109220	308 Win.	5	22"	42"	13 ³ / ₄ "	1/2"	1/2"	6 1/2	12"	799
535109264	270 WSM	3	24"	44"	13 ³ / ₄ "	1/2"	1/2"	7 1/4	10"	859
535109255	300 WSM	3	24"	44"	13 ³ / ₄ "	1/2"	1/2"	7 1/4	10"	859
535109277	325 WSM	3	24"	44"	13 ³ / ₄ "	1/2"	1/2"	7 1/4	10"	859
535109226	270 Win.	5	22"	42 1/2"	13 ³ / ₄ "	1/2"	1/2"	7	10"	799
535109228	30-06 Sprg.	5	22"	42 1/2"	13 ³ / ₄ "	1/2"	1/2"	7	10"	799
535109233	300 Win. Mag.	3	24"	44 1/2"	13 ³ / ₄ "	1/2"	1/2"	7 1/2	10"	859
MODEL 70 SPORTER • Satin Finished Grade I Walnut Stock with Sculpted Cheekpiece, No Sights										
535108264	270 WSM	3	24"	44 1/8"	13 ³ / ₄ "	1/2"	1/2"	7 1/4	10"	\$859
535108255	300 WSM	3	24"	44 1/8"	13 ³ / ₄ "	1/2"	1/2"	7 1/4	10"	859
535108277	325 WSM	3	24"	44 1/8"	13 ³ / ₄ "	1/2"	1/2"	7 1/4	10"	859
535108226	270 Win.	5	24"	44 3/8"	13 ³ / ₄ "	1/2"	1/2"	7 1/4	10"	799
535108228	30-06 Sprg.	5	24"	44 3/8"	13 ³ / ₄ "	1/2"	1/2"	7 1/4	10"	799
NEW 535108230	7mm Rem. Mag.	3	26"	46 3/8"	13 ³ / ₄ "	1/2"	1/2"	7 3/4	9 1/2"	859
535108233	300 Win. Mag.	3	26"	46 3/8"	13 ³ / ₄ "	1/2"	1/2"	7 3/4	10"	859
NEW 535108236	338 Win. Mag.	3	26"	46 3/8"	13 ³ / ₄ "	1/2"	1/2"	7 3/4	10"	859

MODEL 70™ ALL-AROUND TOUGH.

MEAT SMOKER.

*T*HE MODEL 70 ULTIMATE SHADOW HAS THE MOST ADVANCED SYNTHETIC STOCK DESIGN IN THE INDUSTRY. EVERY CONTOUR AND RIDGE, PLUS THE FITTING OF STOCK-TO-STEEL HAVE BEEN CAREFULLY ENGINEERED TO PROVIDE MAXIMUM STRENGTH AND EFFICIENCY WITH MINIMUM WEIGHT. IF YOU'RE LOOKING FOR AN ALL-WEATHER SYNTHETIC STOCK RIFLE WITH GOOD LOOKS AND PRACTICAL FEATURES, DEPEND ON THE MODEL 70 ULTIMATE SHADOW.





WinSorb™
TECHNOLOGY

WinSorb™ Technology. The Model 70 Ultimate Shadow has a WinSorb™ recoil pad, specifically designed for Ultimate Shadow composite stocks. Like the finest gel pad, it cushions and absorbs sharp recoil, allowing more pleasant shooting at the bench, especially with heavy magnum calibers.

Classic External Claw Extractor. The massive external claw extractor smoothly captures nearly one quarter of the base of the cartridge as it releases from the magazine, allowing the bolt to fully control feeding into and guarantee extraction from the chamber.



- **Controlled Round Feeding**
- **Bedded action and free-floating barrel for exceptional long-range accuracy**
- **M.O.A.™ Trigger System**
- **WinSorb™ recoil pad**
- **Lightweight**

ULTIMATE SHADOW At first glance, the Model 70™ Ultimate Shadow, with its flowing lines and integrated, rubberized, oval-dot gripping surfaces on the pistol grip and fore-end looks very different from other composite rifles. When you pick it up, you'll know why. The stock immediately gives you a comfortable, secure hold even when wet or cold. It feels tight in your hands and gives you better control from any shooting position. The Ultimate Shadow is also lightweight so you can carry it into remote, rugged country without worrying about any extra weight or dinging up the rifle. The free-floating barrel and M.O.A.™ Trigger System contribute to exceptional accuracy and its classic, Controlled Round Feed action makes the Ultimate Shadow's receiver the most reliable and smoothest cycling in the industry. The Ultimate Shadow is offered in a 22", 24" or 26" blued barrel and available in popular standard and long magnum calibers, plus three WSM calibers.

MODEL
70™

MODEL 70 ULTIMATE SHADOW PRICES IN U.S. DOLLARS

Item Number	Caliber	Magazine Capacity	Barrel Length	Overall Length	Length of Pull	Drop at Comb	Drop at Heel	Nominal Wt. (lbs.)	Rate of Twist	Sugg. Retail
ULTIMATE SHADOW • Synthetic Stock, No Sights										
535114212	243 Win.	5	22"	41¾"	13½"	¾"	¾"	6½	10"	\$749
535114220	308 Win.	5	22"	41¾"	13½"	¾"	¾"	6½	12"	749
535114264	270 WSM	3	24"	43¾"	13½"	¾"	¾"	6¾	10"	789
535114255	300 WSM	3	24"	43¾"	13½"	¾"	¾"	6¾	10"	789
535114277	325 WSM	3	24"	43¾"	13½"	¾"	¾"	6¾	10"	789
535114226	270 Win.	5	24"	44¼"	13½"	¾"	¾"	6¾	10"	749
535114228	30-06 Sprg.	5	24"	44¼"	13½"	¾"	¾"	6¾	10"	749
NEW 535114230	7mm Rem. Mag.	3	26"	46¼"	13½"	¾"	¾"	7	9½"	789
535114233	300 Win. Mag.	3	26"	46¼"	13½"	¾"	¾"	7	10"	789
NEW 535114236	338 Win. Mag.	3	26"	46¼"	13½"	¾"	¾"	7	10"	789



MODEL 1894™ THE LEVER LEGEND RETURNS.

THE LEGEND.

No GREATER NAMES HAVE EVER BEEN LINKED TOGETHER LIKE WINCHESTER® AND THE MODEL 1894. IN 1862, OLIVER FISHER WINCHESTER AGREED TO MARKET THE HENRY RIFLE. THEN JOHN M. BROWNING CAME ALONG IN 1893 WITH A MODEL THAT WAS A PERFECT MATCH FOR THE NEW 30-30 SMOKELESS CARTRIDGE, USHERING IN A NEW ERA IN FIREARM DEVELOPMENT. AND IN 2010, TWO EXQUISITE MODEL 94S COMMEMORATE THE 200TH ANNIVERSARY OF THE BIRTH OF OLIVER F. WINCHESTER, A MAN OF VISION, A MAN OF DESTINY WHOSE NAME BECAME KNOWN THE WORLD OVER.



MODEL 1894 OLIVER F. WINCHESTER COMMEMORATIVE RIFLES PRICES IN U.S. DOLLARS

	Item Number	Caliber	Magazine Capacity	Barrel Length	Overall Length	Length of Pull	Drop at Comb	Drop at Heel	Nominal Wt. (lbs.)	Rate of Twist	Sugg. Retail
	1894 OLIVER F. WINCHESTER CUSTOM GRADE • 30-30 Winchester, Grade IV/V Walnut Stock, Engraved, Deep Blued Receiver										
NEW	534165114	30-30 Win.	8*	24"	42"	13¼"	2⅞"	3⅝"	8	10"	\$1,959
	1894 OLIVER F. WINCHESTER HIGH GRADE • 30-30 Winchester, Grade II/III Walnut Stock, Engraved, Silver Nitride Receiver										
NEW	534164114	30-30 Win.	8*	24"	42"	13¼"	2⅞"	3⅝"	8	10"	\$1,469

*Total Capacity: 8+1

Delivery starting in 2nd quarter



An authentic Winchester Repeating Arms Company crest adorns the receiver of both rifles.

"One of Five Hundred" is inscribed in gold on the barrel of the Custom Grade rifle.

Oliver F. Winchester's signature decorates the top of the bolt of both rifles.



MODEL 1894 CUSTOM GRADE

What better way to welcome back the timeless Winchester® Model 1894 than with a tribute to Oliver Fisher Winchester. The Model 1894 began at the workbench of John M. Browning, being the first sporting rifle to use smokeless powder. It has been said that the Model 1894 has taken more deer than any other rifle in the world, and with over six million sold, has become by far, the most popular rifle in history. This rifle will have an exquisite 24" half-round, half octagon deeply blued barrel. A buckhorn rear sight is matched with a Marble's® gold bead front sight. The Custom Grade model has Grade IV/V walnut with a rich, high gloss finish to enhance the beautiful wood grain. Deep scroll engraving covers both sides of the blued receiver. Extreme polish, precision fitting and finishes adorn this breathtaking rifle commemorating the 200th anniversary of Oliver F. Winchester's birth. An early Winchester Repeating Arms crest graces the left side of the receiver, with the right side bearing the words, "Two Hundred Years, Oliver F. Winchester," and the dates, "1810 — 2010," in gold. The barrel is deeply polished, with the signature of Oliver F. Winchester in gold on the top of the bolt. The Custom Grade Model 1894 is very limited. Only 500 Custom Grade rifles in sets with the High Grade will be offered.



MODEL 1894 HIGH GRADE

The Winchester Model 1894 High Grade also honors and commemorates the 200th anniversary of Oliver Fisher Winchester's birth in New England in 1810 — a most fitting way to remember a gentleman with the genius and vision to see product potential in firearm development. This model is deeply embellished with delicate scroll work, with Oliver F. Winchester's signature in gold on top of the bolt. The left side of the receiver bears an early Winchester Repeating Arms crest. On the right side are the words, "Two Hundred Years, Oliver F. Winchester," and the dates, "1810 — 2010." The fancy Grade II/III walnut stock is enhanced with a high gloss finish and is delicately checkered, complementing the fine embellishments on the silver nitride receiver. This model is also chambered in the timeless 30-30 Win. caliber, with a deeply blued half-round, half octagon barrel. A buckhorn rear sight is fitted with a Marble's® gold bead front sight. The demand for this model will be great. 500 will be sold as a set with the Custom Grade. The remaining limited quantities will be sold individually.



HISTORICAL OWN A LEVER-ACTION LEGEND.

LIVING LEGENDS.

*H*ISTORY HAS A WAY OF SELECTING THOSE GREAT FIREARM DESIGNS THAT ARE DESTINED TO BECOME LEGENDARY. WINCHESTER REPEATING ARMS IS PROUD TO OFFER TWO MORE EXTRAORDINARY LEVER-ACTION RIFLES FOR 2010. THE MODEL 1886 EXTRA LIGHT OFFERS THE AWESOME POWER OF THE 45-70 GOVT. CARTRIDGE IN A HANDY, SADDLE-WORTHY RIFLE. THE SLEEK MODEL 1895 GIVES TRADITIONALISTS THE LEVER-ACTION THEY LOVE, COMBINED WITH THE PERFORMANCE OF PROVEN CARTRIDGES LIKE THE 405 WIN., 30-40 Krag AND 30-06 SPRG., IN A TRIM, EASY-TO-CARRY RIFLE. PRODUCTION ON BOTH RIFLES IS LIMITED. GET YOURS TODAY, BEFORE THEY AGAIN BECOME HISTORY.





MODEL 1895™ GRADE I The Model 1895 was originally designed by John M. Browning and has a long-proven record of durability, ease of use, exceptional accuracy and power, earned in big game fields across the globe. The Model 1895 Grade I has a deeply blued receiver, lever, straight buttplate and barrel that provides a beautiful contrast to the warm satin finish on the walnut stock. Traditional cut checkering accents the straight grip and Schnabel fore-end, offering you a sure hold in any shooting situation. A top-tang safety, spur hammer, adjustable buckhorn rear sight and a sculpted front sight blade complete this extraordinary rifle. The 2010 production run will be very limited, so make sure you fill that special Model 1895 spot in your gun collection today, before they are gone.



MODEL 1886 EXTRA LIGHT GRADE I Experience the power and performance of the legendary 45-70 Govt. cartridge in this magnificent Model 1886 Extra Light Grade I rifle from Winchester Repeating Arms. Another of John M. Browning's great firearm designs, the Model 1886 features a deeply blued receiver, lever and barrel, along with a matching blued steel end cap and straight buttplate. The half-length magazine helps keep the rifle trim and easy to carry, both afoot and on horseback. A rich satin finish accents the smooth walnut stock. A top-tang safety, adjustable buckhorn rear sight and blade front sight constitute the finishing touches on this legendary rifle. If you've always wanted to ride into the sunset with a great piece of Western history across your saddle, make sure you get your Model 1886 now, because its production will also be very limited.

- **Legendary lever-action rifle designs by John M. Browning**
- **Deeply blued receivers, levers and barrels**
- **Top-tang safeties**
- **Walnut stocks**
- **Adjustable buckhorn sights**

HISTORICAL RIFLES PRICES IN U.S. DOLLARS											
	Item Number	Caliber	Magazine Capacity	Barrel Length	Overall Length	Length of Pull	Drop at Comb	Drop at Heel	Nominal Wt. (lbs.)	Rate of Twist	Sugg. Retail
MODEL 1895 GRADE I • Walnut Stock, Blued Receiver											
NEW	534070154	405 Win.	4	24"	42"	13¼"	2⅞"	3⅝"	8	10"	\$1,179
NEW	534070128	30-06 Sprg.	4	24"	42"	13¼"	2⅞"	3⅝"	8	10"	1,179
NEW	534070115	30-40 Krag	4	24"	42"	13¼"	2⅞"	3⅝"	8	10"	1,179
MODEL 1886 EXTRA LIGHT GRADE I • Walnut Stock, Blued Receiver											
NEW	534053142	45-70 Govt.	4	22"	40½"	13¼"	1⅞"	1⅞"	7¼	22"	\$1,269

MODEL 101™ BELGIAN TRADITION AND QUALITY.

ROCK SOLID.

The WINCHESTER® MODEL 101 IS THE OVER AND UNDER SHOTGUN YOU'VE BEEN LOOKING FOR. MADE IN BELGIUM, ITS SUPER-STRONG ACTION WAS TESTED BY FIRING 25,000 SHELLS WITHOUT A SINGLE PART FAILURE. THE LOW-PROFILE RECEIVER MOVES YOUR HANDS AND EYES CLOSER TO THE BORE CENTERLINE FOR FASTER TARGET ACQUISITION WITH LESS FELT RECOIL, MAKING THE MODEL 101 EXTREMELY PLEASANT TO SHOOT ALL DAY.



LOW-PROFILE RECEIVER

The Model 101 has the drop on the original with the advantage of a low-profile receiver. This means your forward hand can be closer to the bore centerline, bringing your hands, face and sighting plane into a more natural alignment for more intuitive and accurate shooting.

FAMILIAR DIMENSIONS

Today's Model 101 features the same dimensions set long ago by the original. The familiar drop at comb and narrow, comfortable grip ensure time-tested levels of comfort and performance.



PACHMAYER® DECELERATOR® RECOIL PAD

Getting pounded by your gun is now a thing of the past with the patented Pachmayer Decelerator recoil pad with snag-free heel. It's found on all Model 101 shotguns. It reduces felt recoil to very manageable levels, even when shooting heavy magnum loads.



GRIP CAP

Model 101 Light, Sporting and Field models have an elegantly fitted grip cap.

CUT CHECKERING

Every Model 101 has finely cut checkering to improve grip and adding artistic elegance to the walnut stock and forearm.

BACK-BORED TECHNOLOGY

.742" BACK-BORED TECHNOLOGY

Extensive research and testing has proven that when it comes to back-boring, .742" is the ideal interior barrel diameter, ensuring tight, consistent patterns. Any larger and gases blow by the shot cup and reduce pellet velocity. Too small and the pellets are deformed as they pass through the forcing cone, causing poor ballistic performance.

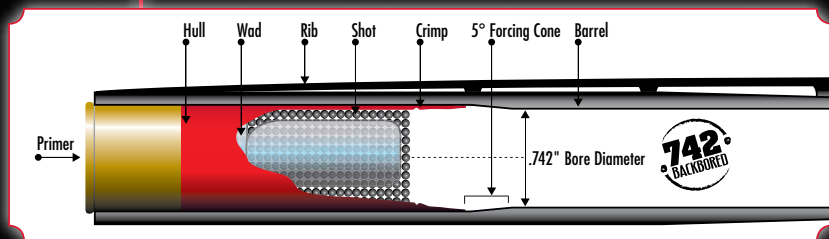

TRUGLO



INVECTOR-PLUS™ CHOKES

From the duck blind to the firing line, the Invector-Plus choke tube system is the world's favorite. All Model 101 shotguns come with either extended Signature Series or flush-mounted tubes, depending on the model. Additional tubes are available at your local Winchester Repeating Arms dealer.

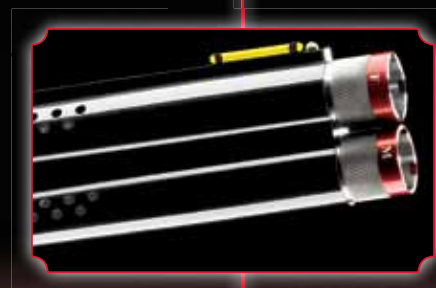

CHROME PLATED CHAMBERS AND BORES

All Winchester Model 101 shotguns have chrome-plated chambers and bores that stand up to the abuse thousands of shells can take. Corrosion resistance is also greatly improved.

STEEL-TOUGH HINGE

All hinge areas bear tension from recoil with each shot, so the Model 101 is built with surfaces that are 49% larger than many competitors. The surfaces are machined simultaneously with the hinge to ensure perfect alignment. The locking lugs have 30% more contact surface than the competition for an action that's built to last!

MODEL 101
WINCHESTER™

MODEL 101™ SWING WITH PERFORMANCE.

The MODEL 101 SPORTING MODEL MEANS SERIOUS PERFORMANCE. THE LOW-PROFILE RECEIVER PLACES YOUR HANDS AND EYES CLOSER TO THE CENTERLINE OF THE BORE, GIVING YOU FASTER TARGET ACQUISITION WITH LESS FELT RECOIL. YOU'LL LOVE THE RICH WALNUT STOCK, SHAPED FOR A NARROWER, LIGHTER AND FASTER FEEL FOR QUICK FOLLOW-UP SHOTS. NO WONDER YOUR SCORES GO UP WHEN YOU HIT THE LINE WITH A MODEL 101.



The Model 101 Pigeon is also available with an adjustable comb stock.

Every Model 101 Sporting/Trap shotgun comes with a durable, fitted ABS hard case imprinted with the Winchester logo.

- Belgian-made quality
- Low-profile receiver with dual locking lugs and a fixed third lug underneath the receiver
- Patented Pachmayr® Decelerator® recoil pad with snag-free heel
- .742" Back-Bored Technology barrels for optimum shot performance
- TRUGLO® fiber-optic sight on Sporting models
- Chrome-plated chambers on all Model 101 shotguns

MODEL 101™

MODEL 101 OVER & UNDER SHOTGUNS PRICES IN U.S. DOLLARS

Item Number	Gauge	Barrel Length	Chamber	Choke Tubes Included	Overall Length	Length of Pull	Drop at Comb	Drop at Heel	Nominal Wt. (lbs.)	Sugg. Retail
MODEL 101 PIGEON TRAP • Grade II/III Walnut Stock with Raised Comb, Made in Belgium										
513057493	12	30"	2¾"	XF, F, IM	47"	14⅝"	1⅜"	2¼"	7	\$2,319
513057494	12	32"	2¾"	XF, F, IM	49"	14⅝"	1⅜"	2¼"	7¼	2,319
MODEL 101 PIGEON TRAP • Grade II/III Walnut Stock, Adjustable Comb*, Made in Belgium										
513059493	12	30"	2¾"	XF, F, IM	47¾"	14⅝"	1½"	2⅝"	7½	\$2,469
513059494	12	32"	2¾"	XF, F, IM	49¾"	14⅝"	1½"	2⅝"	7¾	2,469
MODEL 101 PIGEON SPORTING • Grade II/III Walnut Stock, Adjustable Comb*, Made in Belgium										
513061493	12	30"	2¾"	LF, IM, M, IC, SK	47"	14⅝"	1½"	2¼"	7	\$2,619
513061494	12	32"	2¾"	LF, IM, M, IC, SK	49"	14⅝"	1½"	2¼"	7¼	2,619
MODEL 101 SPORTING • Grade II Walnut Stock, Made in Belgium										
513054492	12	28"	2¾"	LF, IM, M, IC, SK	46"	14⅝"	1⅜"	2⅝"	7¼	\$2,179
513054493	12	30"	2¾"	LF, IM, M, IC, SK	48"	14⅝"	1⅜"	2⅝"	7½	2,179
513054494	12	32"	2¾"	LF, IM, M, IC, SK	50"	14⅝"	1⅜"	2⅝"	7¾	2,179

*Adjustable comb stock dimensions are measured with comb in a mid-position.

FIRE FLIES.





**BACK-BORED
TECHNOLOGY**

TRUGLO

MODEL 101 PIGEON TRAP When you step into a shooting station, you need an over and under that is quick to shoulder and naturally pointing. In other words, a gun that shoots with you. The smoother and more consistent you can shoulder and shoot, the higher your score. The Model 101 Pigeon Trap has all the features you need to shoot better. The 10mm wide steel runway rib, mid-bead sight and TRUGLO® TRU-BEAD® interchangeable fiber-optic front sight offer a true, precise and more technical sight picture. The lightweight barrels are highly polished and feature porting and vented side ribs. An adjustable trigger shoe fine tunes your length of pull. Select from models with either a fixed comb or with an adjustable comb that allows individual height and cast on/off custom fitting in just seconds. All are carved from beautiful high gloss Grade II/III walnut with a slight right-hand palm swell. The Pigeon Trap also features the world-famous Invector-Plus™ choke tube system, .742" Back-Bored Technology and comes with Signature™ Series Extra-Full, Full and Improved Modified choke tubes. A rugged molded ABS hard case is included.



T-Wrench, XF, F, IM



**BACK-BORED
TECHNOLOGY**

TRUGLO

MODEL 101 PIGEON SPORTING Own the range and your competition with a Model 101 Pigeon Sporting shotgun. Proven .742" Back-Bored Technology, combined with the Invector-Plus™ choke tube system and five Signature™ extended tubes (Light-Full, Improved Modified, Modified, Improved Cylinder and Skeet) give you superior shot patterns from the lightweight ported barrels. New, trimmer stock dimensions bring a lighter feel for faster handling and the slight right-hand palm swell makes the grip very comfortable. An adjustable trigger shoe allows you to fine tune length of pull. A wide 10mm runway rib, mid-bead and TRUGLO® TRU-BEAD® competition front sight make picking up targets a breeze. The polished silver nitride receiver finish is elegant, resists wear and complements the high gloss finish on the Grade II/III walnut. A rugged molded ABS hard case is included.



T-Wrench, LF, IM, M, IC, SK



**BACK-BORED
TECHNOLOGY**

TRUGLO

MODEL 101 SPORTING It easily competes with the finest guns on the market in both looks and feel. The richly blued receiver and authentic engraving are framed by high-gloss Grade II walnut. The Sporting includes a long list of high-performance features modern target shooters demand, like the Invector-Plus™ choke tube system with five Signature™ extended tubes (Light-Full, Improved Modified, Modified, Improved Cylinder and Skeet) and .742" Back-Bored Technology to provide optimum shot patterns. Lightweight ported barrels and the finest Pachmayr® Decelerator® sporting pad help control recoil. A 10mm machined runway rib, white mid-bead and TRUGLO® front sight round out this feature-packed shotgun. A rugged molded ABS hard case is included.



T-Wrench, LF, IM, M, IC, SK

MODEL 101™ WATCH THE FEATHERS FLY.

WILD FIRE.

AFFICIONADOS OF WINCHESTER® SHOTGUNS KNOW WELL THE MODEL 101. THE STYLING AND HANDLING ARE LEGENDARY; THE RELIABILITY NEVER IN QUESTION. TODAY'S MODEL 101 IS THE FULL EQUAL OF THE SOUGHT-AFTER ORIGINAL WITH THE ADDED BENEFITS OF MODERN MANUFACTURING TECHNIQUES AND AN ADVANCED LOW-PROFILE DESIGN FOR HANDLING PERFORMANCE. ONE THING THAT ISN'T NEW IS THE HIGH STANDARD OF QUALITY YOU EXPECT FROM A WINCHESTER SHOTGUN. AND, LIKE THE GREATEST OVER AND UNDERS IN HISTORY, THEY'RE MADE IN BELGIUM.



MODEL 101™

- Belgian-made quality
- Low-profile receiver with dual locking lugs and a fixed third lug underneath the receiver
- Patented Pachmayr® Decelerator® recoil pad with snag-free heel
- .742" Back-Bored Technology barrels for optimum shot performance
- Chrome-plated chambers on all Model 101 shotguns

MODEL 101 OVER & UNDER SHOTGUNS PRICES IN U.S. DOLLARS

Item Number	Gauge	Barrel Length	Chamber	Choke Tubes Included	Overall Length	Length of Pull	Drop at Comb	Drop at Heel	Nominal Wt. (lbs.)	Sugg. Retail
MODEL 101 FIELD • Grade II/III Walnut Stock, Made in Belgium										
513046371	12	26"	3"	F, M, IC	43"	14¼"	1⅞"	2⅝"	7	\$1,759
513046361	12	28"	3"	F, M, IC	45"	14¼"	1⅞"	2⅝"	7¼	1,759
MODEL 101 LIGHT • Grade II Walnut Stock, Made in Belgium										
513060391	12	26"	3"	F, M, IC	43"	14¼"	1⅞"	2⅝"	6	\$2,039
513060392	12	28"	3"	F, M, IC	45"	14¼"	1⅞"	2⅝"	6¼	2,039
DELUXE FIELD • Grade II Walnut Stock, Made in Belgium										
513052371	12	26"	3"	F, M, IC	43"	14¼"	1½"	2⅝"	7¼	\$1,679
513052361	12	28"	3"	F, M, IC	45"	14¼"	1½"	2⅝"	7½	1,679
513052360	12	30"	3"	F, M, IC	47"	14¼"	1½"	2⅝"	7¾	1,679



F, M, IC

MODEL 101 FIELD The experience of handling a much more expensive over and under is what you'll find with the Model 101 Field. A high-gloss Grade II/III walnut stock with classic dimensions and a trim grip provide a total performance fit, complemented by the elegance of a deep-relief engraved, low-profile steel receiver. A Pachmayr® Decelerator® recoil pad with a no-slag heel insert is standard. Lightweight profile barrels swing fast, and open and close with tight precision. The Invector-Plus™ choke tube system (Full, Modified and Improved Cylinder) and .742" Back-Bored Technology provide optimum patterning. With a Model 101 Field, the superlative performance of an over and under field gun is yours, and has never been so affordable.



F, M, IC

MODEL 101 LIGHT Take a walk back in time with the Model 101 Light. This beauty traces its heritage back to the original Model 101, one of the finest field guns ever. The Model 101 Light weighs a pound less than other 101 models. The 26" model is only 6 lbs., and the 28" model weighs just 6 lbs. 5 oz. It has an aluminum alloy receiver, delicately adorned with quail on the right side and flushing pheasants on the left. The bottom is engraved with a springer spaniel holding a bird in its mouth. Framing the receiver is a Grade II high gloss walnut stock with the very finest vented Pachmayr® Decelerator® pad with classic white line spacer. No Winchester® has ever had such a superb mix of elegance and extraordinarily fast handling. It comes with three Invector-Plus™ tubes (Full, Modified and Improved Cylinder) and .742" Back-Bored Technology.



F, M, IC

DELUXE FIELD Continuing the rich legacy of the Winchester® is the Deluxe Field, a shotgun every bird hunter should own. Setting the Deluxe Field apart is the engraved steel receiver with silver nitride finish, executed in tasteful satin-finished walnut. A Pachmayr® Decelerator® recoil pad with a no-slag heel insert is standard. Lightweight profile barrels swing fast and fit precisely with the low-profile receiver. The Invector-Plus™ choke system (Full, Modified and Improved Cylinder tubes) offers the shot patterns you need when you need them. The Deluxe Field is a high performance field gun that's very affordable and remains the best value over and under shotgun in the world.

SUPER X[®]3 THE WORLD'S FASTEST SHOTGUN.

HEAT WAVE

The Winchester[®] Super X3 is not only the world's fastest cycling shotgun (12 shots in 1.442 seconds), it's also the world's best fitting, sweetest handling and most advanced autoloader. Here are just a few reasons why the Winchester Super X3 should be in your gun rack.

CAST/DROP SHIMS

Every shooter is different, and no one stock will perfectly fit every person and their shooting style. Composite stock models of the Super X3 allow you to easily adjust both cast on/cast off and drop at comb over a 1/4" range simply by inserting one of the six special shims between the receiver and the buttstock.

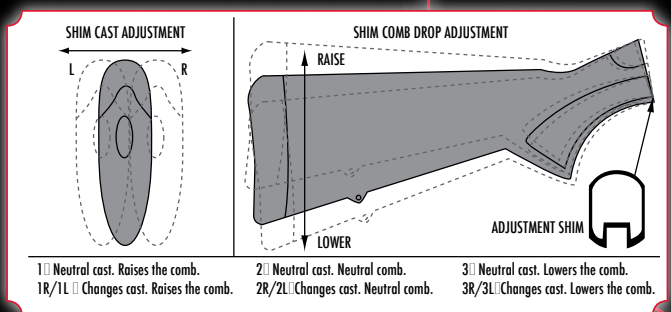

ELECTROLESS NICKEL PLATED BOLT AND SHELL CARRIER

Breech bolts and shell carriers on all Super X3 shotguns are plated with electroless nickel for longer life, reduced friction and greater corrosion resistance. The bolts on Super X3 camo models are also darkened to reduce any reflections that might spook wary birds and other game.



INFLEX RECOIL PAD

Getting pounded by your gun's recoil is a thing of the past with the new Inflex Technology Recoil Pad. Specially shaped rib structures located inside the pad help direct and channel the recoil impulse, moving the comb down and away from your cheek to reduce felt recoil to very manageable levels, even when shooting heavy magnum loads. A hard heel insert on the pad makes mounting the Super X3 snag free.



AMBIDEXTROUS SAFETY

The safety button on the Super X3 is located at the rear of the trigger guard and is easily reversible for both right- or left-handed shooters.

DROP-OUT TRIGGER

The trigger group is easy to remove for cleaning.



LENGTH OF PULL SPACERS

There is no reason to put up with a shotgun that does not fit you, because proper stock fit is critical to comfortable and accurate shooting. Most Super X3 shotguns come with two spacers that fit between the stock and the recoil pad, allowing easy adjustments to length of pull. When the length of pull is adjusted properly, you'll find you can shoulder the gun with ease and confidence, and the felt recoil you experience is greatly diminished. Adjustments range from 13 3/4" to 14 3/8" on wood stocks and from 14 1/4" to 14 3/4" on composite models.





PERMA-COTE™ UT FINISH

UT stands for Ultra Tough. The unique gunmetal gray color of the Super X3 is a heavy-duty finish that looks great and is extremely durable, scratch-resistant and corrosion-resistant to provide year after year of sharp looking performance.



LOAD DIVERSITY

From light factory target shells to heavy waterfowl and turkey loads, the Super X3 shoots them all reliably.

BACK-BORED TECHNOLOGY

.742" BACK-BORED TECHNOLOGY

Extensive research and testing has proven that when it comes to back-boring, .742" is the ideal interior barrel diameter for 12 gauge, ensuring tight, consistent patterns. Any larger and gases blow by the shot cup and reduce pellet velocity. Too small and the pellets are deformed as they pass through the forcing cone, causing poor ballistic performance.

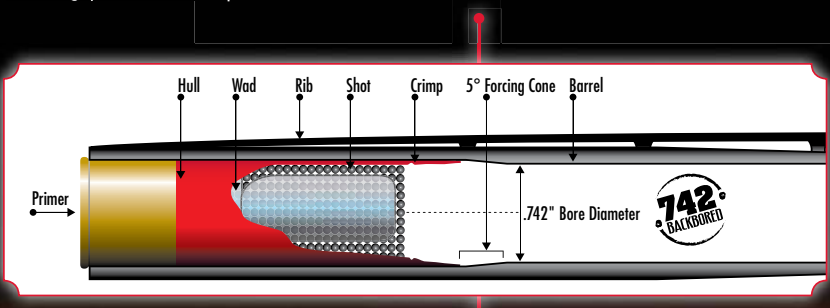

INVECTOR-PLUS™ CHOKE TUBES

From the duck blind to the firing line, the Invector-Plus choke tube system is the world's favorite. The Super X3 comes with either extended Signature Series or flush-mounted tubes, depending on the model. Additional tubes are available at your local Winchester Repeating Arms dealer.

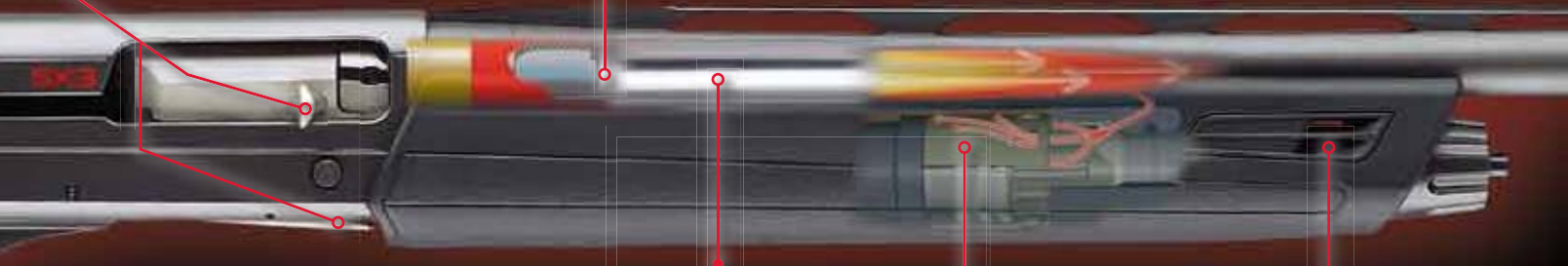

HARD CHROME CHAMBER AND BORE

An optimum feature for durability when using steel or tungsten shot. A chrome bore and chamber are easier to clean, giving you that extra margin of protection when hunting in wet conditions.

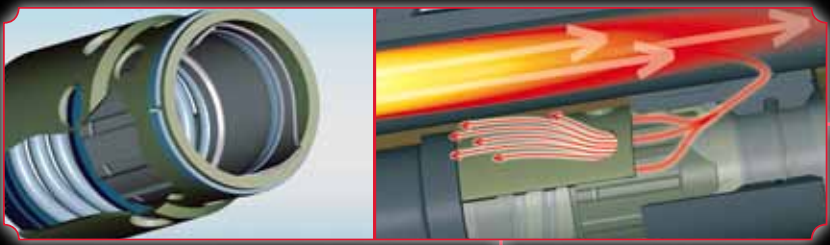

THE ACTIVE VALVE SYSTEM

The Active Valve system automatically self-adjusts, allocating the exact gas pressure necessary to fire a wide range of loads — critical for any autoloader used in real life hunting or target shooting. When firing the heaviest magnum loads in 3½" models, gases vent upward and a portion of the gases are vented forward out of the Quadra-Vent™ ports in the forearm, further regulating bolt speed. 3" models fire everything from light, 1⅛ oz., 2¾" target loads to 3" magnums, while 3½" guns handle everything from 1⅛ oz., 2¾" field loads up to heavy 3½" magnums.

QUADRA-VENT™

Excess gases from heavy loads are channeled through the forward Quadra-Vent ports for greater efficiency and also taming punishing magnum load recoil.



SUPER X[®]3 FAST ENOUGH FOR PATRICK FLANIGAN.

SUPER X3 FLANIGUN EXHIBITION/SPORTING Own a duplicate of the distinctive Super X3 shotgun that Patrick Flanigan shoots in his exciting live shows (the only difference is Patrick's own magazine tube is modified to hold 11 shells). Everything about this unique Super X3 is designed for blazing speed and awesome performance. Light and responsive, the Super X3 makes faster follow-up shots possible because of the reduced felt recoil from the Active Valve system, which allocates gases in a clean, precise manner. The barrel's .742" Back-Bored Technology works with the Invector-Plus™ choke tube system to provide consistent, dense patterns. The Dura-Touch® Armor Coating keeps the stock from slipping in your hands, and the stock is adjustable to fit your shooting style and body type, maximizing overall efficiency of fit, balance and swing. The Inflex Technology recoil pad has a hard heel insert for quick, no snag shouldering.

Now, Patrick's striking red and black Super X3 autoloader can be yours, just like the one he uses to break world records. It is fully configured for exhibition or sporting use, including an additional gas piston to allow the use of a full range of factory loads from the lightest 1 oz. target loads to heavy 3" magnums, all with clockwork reliability.

See Patrick fire 12 shots from his Super X3 in just 1.442 seconds (the fastest dozen ever recorded) at winchesterguns.com/flanigan



DURA-TOUGH
Armor Coating

ACTIVE VALVE
system

BACK-BORED
TECHNOLOGY



T-Wrench, IM, M, IC



Two Gas Pistons The Super X3 Flanigun comes with two interchangeable gas pistons that allow you to fine tune the gun for virtually any factory ammunition.

- 12 shots in 1.442 seconds
- Tested in excess of 30,000 rounds without any critical parts failure
- Patrick owns the world record in breaking 11 hand-thrown clays and in breaking nine clays from the hip
- Flanigan does it all with his Super X3

SXB[®]



SUPER X3 AUTOLOADING SHOTGUN PRICES IN U.S. DOLLARS

Item Number	Gauge	Barrel Length	Chamber	Magazine Capacity	Choke Tubes Included	Overall Length	Length of Full	Drop at Comb	Drop at Heel	Nominal Wt. (lbs.)	Sugg. Retail
FLANIGUN EXHIBITION/SPORTING • Composite Stock, Dura-Touch Armor Coating											
511084392	12	28"	3"	4*	IM, M, IC	49"	14¼"	1¾"	2"	7¼	\$1,479
NEW 511084393	12	30"	3"	4*	IM, M, IC	51"	14¼"	1¾"	2"	7¼	1,479

*Total Capacity: 2¾" = 4+1, 3" = 3+1



Every Super X3 Flanigun shotgun comes with a durable, fitted ABS hard case imprinted with the Winchester logo.

HOT SHOT!

*I*N 2005, PATRICK FLANIGAN SMASHED A WORLD RECORD BY BREAKING 11 HAND-THROWN CLAY TARGETS UNASSISTED BEFORE THEY HIT THE GROUND. IT TOOK INTENSE PRACTICE, LIGHTNING REFLEXES AND HIS INCREDIBLE, SUPER-FAST WINCHESTER® SUPER X®-SERIES AUTOLOADER, NOW FIRMLY ESTABLISHED AS THE WORLD'S FASTEST SHOTGUN. ONE YEAR LATER, PATRICK NABBED ANOTHER WORLD RECORD BY BREAKING NINE HAND-THROWN CLAY TARGETS, SHOOTING THEM UNASSISTED FROM THE HIP WITH HIS SUPER X AUTOLOADER.

HE REIGNS AS KING OF XTREME SPORT SHOOTERS. A HOST OF FEATURES THAT INCLUDES THE PROVEN ACTIVE VALVE GAS SYSTEM ENSURE HIS SHOTGUN PERFORMS FLAWLESSLY, TIME AFTER TIME, IN FRONT OF SPECTATORS. LIKE A FINELY TUNED RACE CAR, THE FEATURES OF THE WINCHESTER® SUPER X®3 COMBINE TO CREATE THE WORLD'S FASTEST AUTOLOADING SHOTGUN.



Patrick Flanigan

SUPER X[®]3 TOUGH GUNS FOR TOUGH CONDITIONS.

COOKED GOOSE.

The WINCHESTER[™] AUTOLOADING SHOTGUN TRADITION LIVES ON WITH THIS PAIR OF RELIABLE, GREAT LOOKING AND TOP PERFORMING COMPOSITE GUNS. THESE SPECIAL SUPER X3 MODELS CARRY ON THE HERITAGE WITH ENHANCED ERGONOMICS AND THE PROVEN SELF-ADJUSTING ACTIVE VALVE SYSTEM THAT OFFER SPEED, REDUCED FELT RECOIL AND RELIABILITY IN ALL TYPES OF WEATHER CONDITIONS.



A red "W" is embedded into the pistol grip on every Super X3 Composite.

- 50% less felt recoil than inertia-operated guns
- 5 shots in .49 seconds
- Tested in excess of 30,000 rounds without critical parts failure
- Removable trigger assembly

SUPER X3 AUTOLOADING SHOTGUN PRICES IN U.S. DOLLARS

Item Number	Gauge	Barrel Length	Chamber	Magazine Capacity	Choke Tubes Included	Overall Length	Length of Pull	Drop at Comb	Drop at Heel	Nominal Wt. (lbs.)	Sugg. Retail
COMPOSITE • Composite Stock, Dura-Touch Armor Coating, Perma-Cote UT											
511053371	12	26"	3"	3*	F, M, IC	47"	14¼"	1¾"	2"	7	\$1,139
511053361	12	28"	3"	3*	F, M, IC	49"	14¼"	1¾"	2"	7¼	1,139
511053271	12	26"	3½"	3*	F, M, IC	47"	14¼"	1¾"	2"	7	1,269
511053261	12	28"	3½"	3*	F, M, IC	49"	14¼"	1¾"	2"	7¼	1,269
CANTILEVER DEER • Composite Stock, Dura-Touch Armor Coating, Fully Rifled Barrel											
511062340	12	22"	3"	3*	N/A	43"	14¼"	1¾"	2"	7	\$1,199

*Total Capacity: 2¾" = 4+1, 3" = 3+1, 3½" = 3+1

SX3[®]



DURA-TOUCH[®]
Armor Coating

ACTIVE VALVE[®]
system

BACK-BORED[®]
TECHNOLOGY



SUPER X3 COMPOSITE The Winchester[®] Super X3 Composite shotgun is the model preferred by many hunters. Here's why: Its tough stock, forearm and trim dimensions feel, and balance, perfectly in your hands and the Dura-Touch[®] Armor Coating provides a sure grip during wet weather conditions. The gunmetal gray Perma-Cote[™] UT (Ultra Tough) surface finish is applied to external metal surfaces for extreme corrosion protection. The bolt is plated with electroless nickel for reduced friction and added corrosion resistance. A weight-saving alloy magazine tube and recoil spring system, slim barrel with a machined rib, and an alloy receiver contribute to the svelte 7 pound weight. The self-adjusting Active Valve gas system and proprietary next generation Inflex Technology recoil pad reduce felt recoil as much as 50% over that of inertia-operated autoloaders. Proven .742" Back-Bored Technology teamed with the Invector-Plus[™] choke tube system provides consistent, dense patterns. 3" and 3½" chambered models are available. Three choke tubes (Full, Modified and Improved Cylinder), two length of pull stock spacers, drop and cast adjustment spacers and sling swivel studs are all included.



DURA-TOUCH[®]
Armor Coating

ACTIVE VALVE[®]
system

BACK-BORED[®]
TECHNOLOGY



TRUGLO

SUPER X3 CANTILEVER DEER Its rifled 22" barrel is optimized to provide unequalled accuracy with 2¾" and 3" sabot slugs. The proven Active Valve System on the Super X3 System reduces recoil and cycles fast for incredible follow-up shot speed. The cantilever design makes it easy to attach an electronic red dot, or conventional, scope to the Weaver-style rail, yet still allows you to aim with the adjustable rear sight and the TRUGLO[®] fiber-optic front sight. The Cantilever Deer also features the durable gunmetal gray Perma-Cote[™] UT (Ultra Tough) surface finish on the barrel and receiver. The bolt is plated with electroless nickel for reduced friction and extreme corrosion resistance. Dura-Touch[®] Armor Coating on the composite stock and forearm improves your grip in all conditions. Two length of pull stock spacers, drop and cast adjustment spacers and sling swivel studs are included.

SUPER X[®]3 RUGGED AND READY FOR ACTION.

ROAST DUCK.

*T*HE SUPER X3 SHOTGUN BLENDS THE PROVEN TECHNOLOGY OF THE ACTIVE VALVE GAS SYSTEM WITH UPDATED FEATURES AND DISTINCTIVE STYLING TO CREATE AN AUTOLOADER THAT'S READY FOR ANY HUNTING CHALLENGE. THE STOCK AND FOREARM FEATURE SPECIAL CURVES, ANGLES AND CONTOURS THAT HELP ENHANCE THE EFFECTIVENESS OF THE CAMOUFLAGE. THE TRIM STOCK AND FOREARM DIMENSIONS AND DURA-TOUCH[™] ARMOR COATING PROVIDE A SECURE FEEL, EVEN WITH HEAVY GLOVES. WHETHER LYING IN A WET BLIND, SLOGGING THROUGH FLOODED TIMBER OR SPENDING A LONG DAY ON THE RIVER JUMP SHOOTING, YOU'LL ALWAYS KNOW YOU CAN COUNT ON THE SUPER X3.





F, M, IC

SUPER X3 WATERFOWL Don't let a shiny shotgun flare wary geese. The Super X3 Waterfowl 3½" in high-definition Mossy Oak® Duck Blind® camo is the only choice. It's made specifically for savvy waterfowlers with a weather-resistant composite stock and forearm with grip-enhancing Dura-Touch® Armor Coating finish. The bolt is plated with electroless nickel for reduced friction and added corrosion resistance. The barrel has an improved ventilated rib design and features .742" Back-Bored Technology and the Invector-Plus™ choke tube system for ideal shot patterns. The Active Valve system reliably cycles factory ammunition from 1¼ oz., 2¾" field loads to heavy 3½" magnums. Three choke tubes (Full, Modified and Improved Cylinder), two length of pull stock spacers, drop and cast adjustment shims and sling swivel studs are included.



DURA-TOUCH
Armor Coating

ACTIVE VALVE
system

BACK-BORED
TECHNOLOGY



DURA-TOUCH
Armor Coating

ACTIVE VALVE
system

BACK-BORED
TECHNOLOGY

MOSSY OAK
BREAK-UP
INFINITY

SUPER X3 ALL-PURPOSE FIELD In the tight confines of flooded timber a balanced, fast swinging, reliable shotgun that can handle the most severe conditions is a must, and the Super X3 All-Purpose Field 3½" is your gun. The gas-operated Active Valve System cycles a wide variety of loads, and reduces felt recoil vastly better than inertia-operated systems. The entire shotgun is fully concealed in new Mossy Oak® Break-Up® Infinity camo with Dura-Touch® Armor Coating for superb grip, feel and protection. The bolt is plated with electroless nickel for reduced friction and added corrosion resistance, while the fast swinging barrel features the Invector-Plus™ choke tube system and .742" Back-Bored Technology for optimal patterning. Three choke tubes (Full, Modified and Improved Cylinder), two length of pull stock spacers, drop and cast adjustment shims and sling swivel studs are included.



F, M, IC

SX3®

- Self-adjusting Active Valve provides world-class performance capable of firing 12 shells in 1.442 seconds
- Patented next generation Inflex Technology pad absorbs recoil, and the slick heel insert won't grab clothing when shouldering
- Easily customized length of pull
- Lightweight magazine tube and recoil spring system trim weight by ¾ of a pound

SUPER X3 AUTOLOADING SHOTGUN PRICES IN U.S. DOLLARS

Item Number	Gauge	Barrel Length	Chamber	Magazine Capacity	Choke Tubes Included	Overall Length	Length of Pull	Drop at Comb	Drop at Heel	Nominal Wt. (lbs.)	Sugg. Retail
WATERFOWL • Composite Stock, Mossy Oak Duck Blind, Dura-Touch Armor Coating											
511074271	12	26"	3½"	3*	F, M, IC	47"	14¼"	1¾"	2"	7	\$1,469
511074261	12	28"	3½"	3*	F, M, IC	49"	14¼"	1¾"	2"	7¼	1,469
ALL-PURPOSE FIELD • Composite Stock, New Mossy Oak Break-Up Infinity, Dura-Touch Armor Coating											
NEW 511117291	12	26"	3½"	3*	F, M, IC	47"	14¼"	1¾"	2"	7	\$1,469
NEW 511117292	12	28"	3½"	3*	F, M, IC	49"	14¼"	1¾"	2"	7¼	1,469

*Total Capacity: 2¾" = 4+1, 3" = 3+1, 3½" = 3+1

SUPER X[®]3 TOM TOOLERY.

RED HEAD.

LEAVE NOTHING TO CHANCE WHEN YOU'VE MANAGED TO TRICK A BIG TOM BY CALLING HIM INTO RANGE. YOU NEED A SHOTGUN YOU CAN COUNT ON, LIKE THE EXCLUSIVE WINCHESTER[®] SUPER X3 NWTF[®] CANTILEVER EXTREME TURKEY. IT'S LOADED WITH GREAT FEATURES LIKE A NEW TRUGLO[®] RED DOT ELECTRONIC SIGHT, FOLDING REAR SIGHT, MOSSY OAK[®] CAMO FOR ULTIMATE CONCEALMENT AND DENSE PATTERNING EXTENDED EXTRA-FULL CHOKE TUBES. YOU ONLY HAVE TO SHOOT ONE TO DISCOVER THE PERFORMANCE OF THE SUPER X3. THE WINCHESTER SUPER X3 NWTF CANTILEVER EXTREME TURKEY IS THE PERFECT TOOL FOR TROPHY TURKEY HUNTING.



Every Super X3 NWTF Cantilever Extreme Turkey shotgun comes with a durable ABS hard case imprinted with the Winchester logo.





Quadra-Vent™ Forward Ducting System. This improved design facilitates more efficient venting of excess gases forward, away from the shooter. This is a special advantage when shooting heavy 3½" loads where the Active Valve system regulates bolt speed by venting off additional gases through the piston.

Inflex Technology Recoil Pad. This ultra soft pad offers the best recoil absorption available. The proprietary construction and material promote a directional deflection of recoil forces, pulling the stock comb away from your face to reduce felt recoil and muzzle climb. The hard heel insert allows no-slag shouldering.

Fine Tune Cast and Drop. All Super X3 Composite shotguns include spacers to adjust stock drop and cast over a ¼" range. The spacers fit between the stock and receiver to lock in your personalized dimensions.



SUPER X3 NWTF® CANTILEVER EXTREME TURKEY

You can't miss with a TRUGLO® Red Dot scope, included with the Super X3 NWTF Cantilever Extreme Turkey! The Active Valve system reduces felt recoil by expelling excess gases before it reaches your shoulder. The 24" barrel with 3½" chamber and an Extra-Full Extended Turkey choke tube make this one incredible turkey gun. Extra features include the protective Dura-Touch® Armor Coating on the weather-resistant camo composite stock, an adjustable rear sight and a TRUGLO® fiber-optic front sight. The .742" Back-Bored Technology provides optimum shot patterns. Steel sling swivel studs are included.



DURA-TOUCH®
Armor Coating

ACTIVE VALVE
system

BACK-BORED
TECHNOLOGY

TRUGLO



TRUGLO® DELUXE RED DOT SCOPE

Improve your shooting speed and accuracy at extended ranges with a TRUGLO® electronic Red Dot scope, now included as standard equipment on the Super X3 NWTF® Cantilever Extreme Turkey model. The crisp 5 MOA red dot scope can be adjusted for 11 levels of brightness to match any lighting conditions, and offers easy-to-zero click adjustments for both windage and elevation. With unlimited eye relief and a wide field of view, precise sighting, even from difficult field shooting positions, is now possible. Multi-coated lenses and internal surface treatments help eliminate reflections. This durable unit is waterproof, fog proof and is rated for 1000 Gs of shock resistance. The integrated Weaver-style mount allows quick attachment and removal from the barrel-mounted cantilever rail without loss of zero. Mossy Oak® New Break-Up® camouflage ensures total concealment from wary eyes.



EXTRA-FULL TURKEY CHOKE TUBE

A tight, dense pattern of heavy shot is critical for taking turkeys. You get an Invector-Plus™ Extra-Full Turkey choke tube standard, with the Super X3 NWTF® Cantilever Extreme Turkey. The black knurled band makes it easy to install or remove and the camo band won't give you away to a wary tom.

SUPER X3 AUTOLOADING SHOTGUN PRICES IN U.S. DOLLARS

Item Number	Gauge	Barrel Length	Chamber	Magazine Capacity	Choke Tubes Included	Overall Length	Length of Pull	Drop at Comb	Drop at Heel	Nominal Wt. (lbs.)	Sugg. Retail
NWTF CANTILEVER EXTREME TURKEY • Composite Stock, MONBU, TRUGLO Scope, Extra-Full Turkey Tube											
511082290	12	24"	3½"	4*	T	45"	14¼"	1¾"	2"	7¼	\$1,539

*Total Capacity: 2¾" = 4+1, 3" = 3+1, 3½" = 3+1



SUPER X[®]3 FIRE UP THE NEW 20 GAUGE.

HOT DOGS.

*A*LL THE INCREDIBLE FEATURES OF THE SUPER X3 ARE NOW FOUND IN A NEW 20 GAUGE FOR 2010, INCLUDING A TRIMMER STOCK, GRIP AND FOREARM DIMENSIONS FOR LIGHTER, FASTER CONTROL. ULTRALIGHT MAGAZINE TUBES AND LIGHTWEIGHT RECOIL SPRING SYSTEMS REMOVE NEARLY $\frac{3}{4}$ OF A POUND OF WEIGHT. LIGHTWEIGHT BARRELS FURTHER REDUCE WEIGHT WITH NARROW PROFILES AND MACHINED RIBS. BOTH 12 AND 20 GAUGE FEATURE BACK-BORED TECHNOLOGY FOR THE IDEAL COMBINATION OF SHOT UNIFORMITY AND VELOCITY. THE GUNMETAL GRAY PERMA-COTE™ UT (ULTRA TOUGH) FINISH IS MORE DURABLE AND CORROSION RESISTANT THAN TRADITIONAL BLUED FINISHES. WINCHESTER® SUPER X3 SHOTGUNS ARE WORLD-RENOWNED FOR CENTERED BALANCE, SUPERIOR FIT AND SMOOTH FOLLOW THROUGH.





Unique Checkering. Stylish checkering graces the stock on the Super X3 Walnut Field, offering bold looks and an enhanced grip.

Adjustable Length of Pull. Spacers fit between the stock and recoil pad to customize your Super X3 Walnut Field to your exact measurements. Two spacers are included with every Super X3 Walnut Field to adjust stock length between 13³/₄" and 14¹/₄" on wood stocks and 14¹/₄" and 14³/₄" on composite stocks.

Perma-Cote™ UT Finish. UT stands for Ultra Tough. The unique gunmetal gray color of the Super X3 is a heavy-duty finish that looks incredible and is extremely durable, scratch-resistant and corrosion-resistant for years of sharp looking performance.

SUPER X3 WALNUT FIELD 12 GAUGE



F, M, IC

SUPER X3 WALNUT FIELD 20 GAUGE



F, M, IC

SUPER X3 WALNUT FIELD

Bold looks and innovative features make the Winchester® Super X3 Field shotgun a shotgun to be reckoned with. It weighs in at a scant 6³/₄ pounds, thanks to a weight-saving magazine tube and recoil spring system, slim barrel with a machined rib, and an alloy receiver. The 3" chambered Super X3 Walnut Field has all the features you want in a field or sporting gun. The self-adjusting Active Valve gas system reduces recoil significantly more than inertia-operated systems and a soft Inflex Technology recoil pad offers the best recoil absorption available. Trim grip and forearm dimensions add to the lightweight, fast handling feel. The .742" Back-Bored Technology and Invector-Plus™ choke tube system work together to provide perfect patterns. A unique gunmetal gray Perma-Cote™ UT (Ultra Tough) surface finish is applied to external surfaces for extreme corrosion protection, and the bolt is plated with electroless nickel for reduced friction and added corrosion resistance. This is one shotgun you must experience to believe. Three choke tubes (Full, Modified, Improved Cylinder) and two stock spacers for length of pull adjustments are included.

WALNUT FIELD 20 GAUGE

What could be finer than enjoying all the incredible features of the Super X3 in a sweet swinging 20 gauge autoloader? There are several benefits to shooting a smaller gauge. Women and lighter-framed shooters also enjoy a 20 gauge since there is less recoil and a smaller gauge shotgun is easier to handle. The new 20 gauge has all the features of the 12 gauge Walnut Field, including a machined rib with solid brass bead at the muzzle, the self-adjusting Active Valve gas system for reduced felt recoil and a trim grip and forearm. A traditionally-styled, Pachmayr® Decelerator® pad absorbs recoil and length of pull is adjustable with two spacers provided. The back-bored, Invector-Plus™ choke system ensures tight, consistent patterns. Full, Modified and Improved Cylinder choke tubes are included. The gunmetal gray Perma-Cote™ UT protects against the elements. Experience the performance and speed of the Super X3 in a great, light 20 gauge.



SUPER X3 AUTOLOADING SHOTGUN PRICES IN U.S. DOLLARS												
Item Number	Gauge	Barrel Length	Chamber	Magazine Capacity	Choke Tubes Included	Overall Length	Length of Pull	Drop at Comb	Drop at Heel	Nominal Wt. (lbs.)	Sugg. Retail	
WALNUT FIELD • Walnut Stock, Length of Pull Adjustment												
511054371	12	26"	3"	4*	F, M, IC	47"	14 ¹ / ₄ "	1 ⁵ / ₈ "	2"	6 ³ / ₄	\$1,199	
511054361	12	28"	3"	4*	F, M, IC	49"	14 ¹ / ₄ "	1 ⁵ / ₈ "	2"	7	1,199	
WALNUT FIELD 20 GAUGE • Walnut Stock, Traditional Checkering												
NEW 511054691	20	26"	3"	4*	F, M, IC	47"	14 ¹ / ₄ "	1 ⁵ / ₈ "	2"	6 ³ / ₈	\$1,199	
NEW 511054692	20	28"	3"	4*	F, M, IC	49"	14 ¹ / ₄ "	1 ⁵ / ₈ "	2"	6 ¹ / ₂	1,199	

*Total Capacity 12 Gauge: 2³/₄" = 4+1, 3" = 4+1; 20 Gauge: 2³/₄" = 4+1

SUPER X[®] PUMP THE FASTEST PUMP.

SPEEDY.

*T*HE NEW WINCHESTER[®] SUPER X PUMP IS VERY CLOSE TO BEING THE PERFECT PUMP SHOTGUN. BECAUSE OF ITS INERTIA-ASSISTED SLIDE-ACTION, IT'S THE FASTEST IN THE WORLD IN FOLLOW-UP SHOTS. THREE SHOTS CAN BE DELIVERED IN JUST A HALF SECOND. PICK ONE UP AND SEE IF IT'S NOT THE FINEST FITTING, SWEETEST HANDLING AND FASTEST PUMP OUT THERE.

BLACK CHROME PROTECTION

Better than conventional bluing, black chrome finishes stand up to years of wear and last longer. Parts and surfaces are easier to clean and stay cleaner.

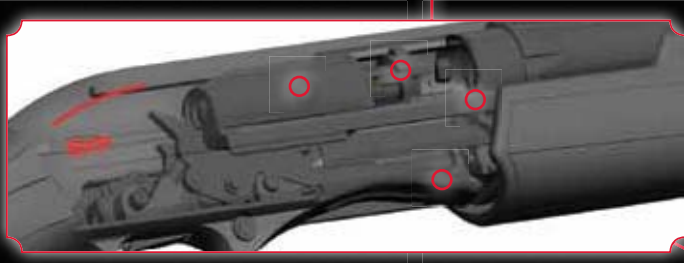

ROTARY BOLT

Four massive lugs allow inertia to start the forearm and slide mechanism rearward as the stock recoils against your shoulder, giving you a head start on the next shot. Dual steel action bars eliminate twisting, binding and wasted time and energy when cycling the action.

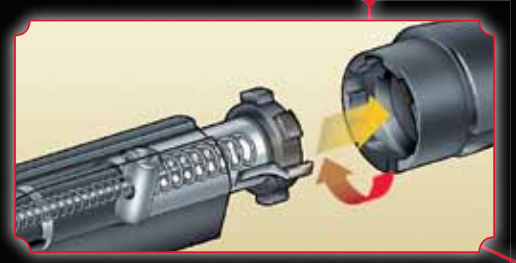

INFLEX RECOIL PAD

Recoil absorption is critical on any shotgun, and the new Super X Pump has the best pad made. Rib structures inside the pad help direct and channel the recoil impulse, moving the comb down and away from your cheek. A hard heel insert on the pad makes mounting the Super X Pump snag free.



FAMILIAR DIMENSIONS

The Super X Pump composite stock provides you with the same familiar feel of the Super X3. Pistol grip radius, trigger reach, comb height and length of pull are all patterned after the fastest autoloader in the world. The stock bolt passes through wrist of the stock and attaches solidly into the back of the alloy receiver.



DROP-OUT TRIGGER GROUP

Removing one pin allows you to drop out the complete trigger system for cleaning and inspection. Nothing could be simpler in keeping your Super X Pump in excellent working condition.



.742" BACK-BORED TECHNOLOGY

Extensive research and testing has proven that when it comes to back-boring, .742" is the ideal interior barrel diameter, ensuring tight, consistent patterns. Any larger and gases blow by the shot cup and reduce pellet velocity. Too small and the pellets are deformed as they pass through the forcing cone, causing poor ballistic performance.

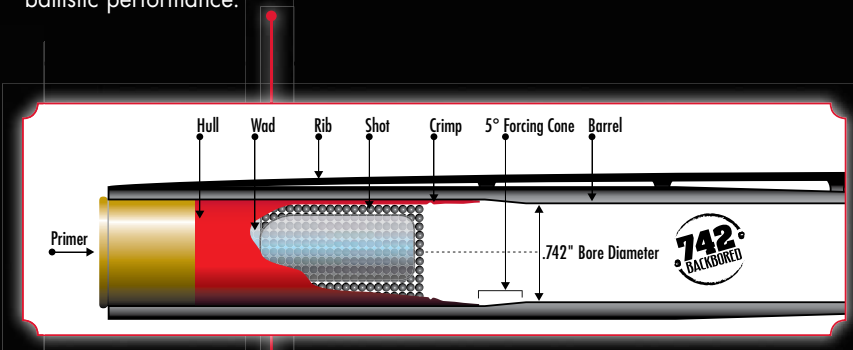

INVECTOR-PLUS™ CHOKE TUBES

From the duck blind to the firing line, the Invector-Plus choke tube system is the world's favorite. The Super X Pump comes with full, modified and improved cylinder flush-mounted tubes so your gun is ready to shoot right out of the box. Additional tubes are available at your local Winchester Repeating Arms dealer.



HARD CHROME CHAMBER AND BORE

An optimum feature for durability when using steel or tungsten shot. A chrome bore and chamber are easier to clean, giving you that extra margin of protection when hunting in wet conditions.

CROSSBOLT SAFETY

The crossbolt safety button on the Super X Pump is located on the front of the trigger guard for easy access, even when wearing gloves.

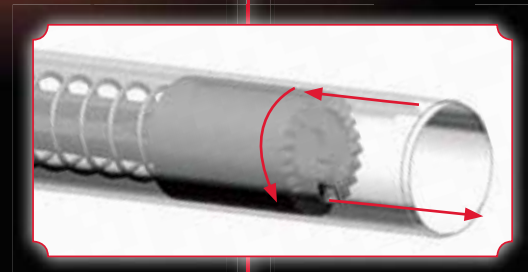

SPEED-PLUG SYSTEM

When removing the three-shot adapter simply remove the magazine cap, push on the spring retainer holding the spring in place and remove the adapter. It's trouble-free and in seconds, you can remove or install the adapter.



SUPER X[®] PUMP THE WORLD'S FASTEST PUMP.

FIRE PUMP.

PICK UP THE NEW WINCHESTER[®] SUPER X PUMP SHOTGUN AND EXPERIENCE ITS LIGHT WEIGHT, CENTERED BALANCE AND INSTANT POINTABILITY FIRSTHAND. THE SUPER X PUMP DESIGN PROVIDES YOU WITH THE FASTEST FOLLOW-UP SHOTS. NO OTHER PUMP OFFERS THE FEELING OF AN INERTIA-ASSISTED SLIDE-ACTION THAT CAN DELIVER THREE SHOTS IN A MERE HALF-SECOND.



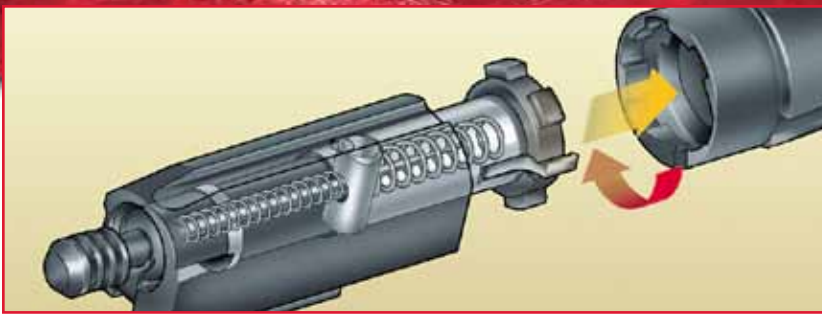

The Rotary Bolt. Four massive lugs allow inertia to start the forearm and slide mechanism moving rearward as the stock recoils against your shoulder, giving you a head start on loading the next shot. Dual steel action bars eliminate twisting, binding and wasted time and energy when cycling the action.

The Super X Pump is FAST! Patrick Flanigan uses the Super X Pump shotgun in his Xtreme Shooting shows because of its incredible speed. See him in action at winchesterguns.com/flanigan



BLACK SHADOW® FIELD Rugged reliability with a non-glare matte finish on the barrel and receiver that won't cause birds to flare. The durable composite stock and forearm are up to tough conditions. The hard working Super X Pump action fires all factory 2¾" and 3" steel, tungsten, bismuth and lead loads through a new, chrome plated .742" back-bored barrel with Invector-Plus™ chokes, ensuring optimum patterns. Available with either a 26" or 28" barrel.



DEFENDER Easy to pack and carry, handling buckshot or rifled slugs efficiently through the fully chrome plated, 18" fixed cylinder choked barrel (no constriction) for wide patterning. This open choke is also very accurate when using Foster-type slugs. It has non-glare metal surfaces with a tough composite stock and forearm. Additional features include a five-shot magazine (plus one in the chamber), and a positive, deeply grooved forearm for control and stability.

STAY SAFE AND SOUND WITH THE DO-IT-ALL DEFENDER. USE IT FOR HOME SECURITY, COMPETITION OR HUNTING. IT ALSO PACKS EASILY FOR CAMPING. THE SIX-SHELL CAPACITY, COMPOSITE STOCK AND FOREARM IMPART CONFIDENCE AND CAPABILITY. IT'S ALL THE GUN YOU NEED FOR SECURITY AND PEACE OF MIND.

- The Super X Pump Black Shadow Field has a .742" Back-Bored Technology barrel with the Invector-Plus™ choke system for less shot deformation
- All barrels are fully chrome plated for added durability using steel or tungsten shot and are easy to clean, giving you that extra margin of protection when hunting in wet conditions
- Inflex Technology Recoil Pad
- The only pump shotgun fast enough for Xtreme Sport Shooter Patrick Flanigan

SUPER X PUMP SHOTGUN PRICES IN U.S. DOLLARS											
Item Number	Gauge	Barrel Length	Chamber	Magazine Capacity	Choke Tubes Included	Overall Length	Length of Pull	Drop at Comb	Drop at Heel	Nominal Wt. (lbs.)	Sugg. Retail
BLACK SHADOW FIELD • Composite Stock											
512251391	12	26"	3"	4*	F, M, IC	47"	13¾"	1¾"	2"	7	\$379
512251392	12	28"	3"	4*	F, M, IC	49"	13¾"	1¾"	2"	7¼	379
DEFENDER • Composite Stock											
512252395	12	18"	3"	5*	N/A	39½"	13¾"	1¾"	2"	6½	\$319

*Total Capacity: Field: 2¾" = 4+1, 3" = 3+1, Defender: 2¾" = 5+1, 3" = 4+1

ACCESSORIES

CUSTOMIZE YOUR FIREARM.



CHOKE TUBES PRICES IN U.S. DOLLARS

Item Number	Gauge	Description	Diameter	Constriction	Sugg. Retail
SIGNATURE INVECTOR-PLUS CHOKES • 12 Gauge for Winchester Supreme, Select, Super X2, Super X3 and Super X Pump Shotguns					
NEW 61307103	12	Turkey	.660	.082	\$44
6130703	12	Extra-Full Trap	.700	.040	44
6130713	12	Full	.705	.035	44
6130723	12	Light Full	.710	.030	44
6130733	12	Improved Modified	.715	.025	44
6130743	12	Modified	.720	.020	44
6130753	12	Light Modified	.725	.015	44
6130763	12	Improved Cylinder	.730	.010	44
6130773	12	Skeet	.735	.005	44
6130783	12	Cylinder	.740	.000	44
6130793	12	Spreader	Rifled	—	64
INVECTOR-PLUS CHOKES • 12 Gauge & 20 Gauge for Winchester Supreme, Select, Super X2, Super X3 and Super X Pump Shotguns					
613061	20	Full	.606	.024	\$29
613062	20	Improved Modified	.612	.018	29
613063	20	Modified	.615	.015	29
613064	20	Improved Cylinder	.621	.009	29
613065	20	Skeet	.624	.006	29
613066	20	Cylinder	.630	.000	29
613050	12	Extra-Full	.700	.040	34
613051	12	Full	.705	.035	29
613052	12	Improved Modified	.715	.025	29
613053	12	Modified	.720	.020	29
613054	12	Improved Cylinder	.730	.010	29
613055	12	Skeet	.735	.005	29
613056	12	Cylinder	.740	.000	29
6130043	12	T-Wrench	—	—	19
STANDARD INVECTOR CHOKES • 12 Gauge for Winchester Super X2 Practical Models					
6130303	12	Full	.690	.035	\$19
6130313	12	Improved Modified	.700	.025	19
6130323	12	Modified	.705	.020	19
6130333	12	Improved Cylinder	.715	.010	19
6130343	12	Skeet	.720	.005	19
6130353	12	Cylinder	.725	.000	19
6130033	12	T-Wrench	—	—	19

WINCHESTER® CHOKE TUBES

Winchester Signature® choke tubes are unsurpassed in the shotgun industry. In collaboration with one of the finest makers of choke tubes in the world, the Invector-Plus® and Standard Invector® tubes are carefully machined from the best materials and calibrated to the strictest tolerances to deliver shot patterns exceeding your highest expectations. Installing these tubes in your barrel insures that you are getting optimum patterning for the most challenging of wild game and the most difficult presentations in clay target shooting.

EXTRA SHOTGUN BARRELS PRICES IN U.S. DOLLARS

Item Number	Gauge	Chamber	Barrel Length	Description	Sugg. Retail
SUPER X3 FIELD AND TURKEY BARRELS • 12 Gauge					
611053271	12	3½"	26"	Perma-Cote UT, Vent Rib, with 1 Modified Invector-Plus Choke Tube	\$519
611053261	12	3½"	28"	Perma-Cote UT, Vent Rib, with 1 Modified Invector-Plus Choke Tube	519
611054371	12	3"	26"	Perma-Cote UT, Vent Rib, with 1 Modified Invector-Plus Choke Tube	419
611054361	12	3"	28"	Perma-Cote UT, Vent Rib, with 1 Modified Invector-Plus Choke Tube	419
611053253	12	3½"	24"	Perma-Cote UT, Vent Rib, TRUGLO® Sights, w/1 X-Full Extended Invector-Plus Choke Tube	519
SUPER X3 DEER BARRELS • 12 Gauge					
611108340	12	3"	22"	Black, Rifled, Cantilever Scope Mount and Synthetic Forearm*	\$579
611107340	12	3"	22"	MOBU, Rifled, Cantilever Scope Mount and Synthetic Forearm*	659
NEW 611121340	12	3"	22"	MOBU Infinity, Rifled, Cantilever Scope Mount and Synthetic Forearm*	659
611108240	12	3½"	22"	Black, Rifled, Cantilever Scope Mount and Synthetic Forearm*	629
611107240	12	3½"	22"	MOBU, Rifled, Cantilever Scope Mount and Synthetic Forearm*	699
NEW 611121240	12	3½"	22"	MOBU Infinity, Rifled, Cantilever Scope Mount and Synthetic Forearm*	699
SUPER X2 FIELD AND TURKEY BARRELS • 12 Gauge					
611063253	12	3½"	24"	Matte Blue, Vent Rib, TRUGLO® Sights, w/1 X-Full Extended Invector-Plus Choke Tube	\$499
611064350	12	3"	26"	Gloss Blue, Vent Rib, with 1 Modified Invector-Plus Choke Tube	379
611063346	12	3"	28"	Matte Blue, Vent Rib, with 1 Modified Invector-Plus Choke Tube	379
SUPER X2 DEER BARREL • 12 Gauge					
611101240	12	3½"	22"	Matte Blue, Rifled, Cantilever Scope Mount	\$549

Do not attempt the use of 3½" chambered barrels with 3" receivers nor 3" chambers with 3½" receivers.

*To prevent damage to forearms, all Super X3 rifled cantilever barrels are delivered with a new forearm specifically designed to fit over the thicker, rifled barrel wall.



Detachable Floorplate Magazine



Hinged Floorplate Magazine

SUPER X RIFLE EXTRA MAG PRICES IN U.S. DOLLARS

Item Number	Description	Sugg. Retail
SUPER X RIFLE HINGED FLOORPLATE MAGAZINE		
112029907	30-06 Sprg.	\$69
112029906	300 Win. Mag.	69
112029904	270 WSM	69
112029905	300 WSM	69
SUPER X RIFLE DETACHABLE FLOORPLATE MAGAZINE		
112029903	30-06 Sprg.	\$69
112029902	300 Win. Mag.	69
112029900	270 WSM	69
112029901	300 WSM	69

CUSTOMER SERVICE FOR WINCHESTER® FIREARMS

You can expect the same great Customer Service you've become accustomed to over the years. Expert gunsmiths can help you with the most technical problems and repairs to your firearms. There are many Authorized Repair Centers (ARC) throughout the country with gun repair professionals who know your firearm inside and out. If you need service on current models, as well as older Model 70, Model 94, Model 9422 or Model 1300 firearms, please contact one of the Authorized Repair Centers or our main Service Center in Arnold, Missouri. Please call (800) 333-3288 for more information.

WINCHESTER® REPEATING ARMS

Customer Service Department
275 Winchester Avenue
Morgan, UT 84050
(800) 945-5237
(801) 876-3440

Parts and Service
3005 Arnold Tenbrook Road
Arnold, MO 63010
(800) 322-4626



All Winchester firearms are shipped with a free locking device to assist in the safe storage of firearms. (Not shown actual size.)



FOR FIREARMS: WINCHESTERGUNS.COM FOR AMMUNITION: WINCHESTER.COM

Owner's manuals for all Winchester® firearms in this or previous catalogs are available upon request at no charge. Owners of Winchester firearms without owner's manuals are encouraged to view one online or request one at the address below. Some models and calibers are only made periodically. Winchester Repeating Arms (WRA) reserves the right to delay, postpone or discontinue production of any Winchester firearm for any reason without notice. All specifications in this catalog are subject to change without notice. Weights, stock dimensions, wood appearance, etc., may vary slightly between individual firearms. Wood is a natural product. No two pieces are alike and variation between stocks is to be expected. WRA reserves the right to modify or change specifications without notice. WRA will make every effort to make sure this catalog is accurate at the time of printing and apologizes for any errors in photographs, descriptions and specifications.

Please note that the following models are or were manufactured in Japan: Models 1885, 1886, 1892, 1895, 63 and 52B. Super X2, Super X3, and 101 shotguns are manufactured in Belgium and assembled in Portugal. Model 70 rifles are manufactured in the USA. The following trademarks are used with permission from the Olin Corporation: Winchester, the Horse and Rider design, Super X, SX2 design, Super X2, SX3 design, Super X3, SXR design, Model 1892, Select, Model 101, Model 1300, Model 94, Model 70, Model Super X Pump and the red W design. Other trademarks used in this catalog: Mossy Oak Duck Blind and Mossy Oak New Break-Up are registered trademarks of Haas Outdoors. Pachmayr and Decelerator are registered trademarks of Lyman. Invector-Plus, Dura-Touch and Perma-Cote are trademarks of Browning. TRUGLO is a trademark of Truglo, Inc. © Copyright, WRA August 2009. No part of this catalog may be reproduced without the written permission of Winchester Repeating Arms. Suggested retail pricing is in U.S. dollars and approximate and subject to change without notice. If you have any questions concerning Winchester brand firearms, visit your Winchester firearms dealer or write to: Winchester Repeating Arms, 275 Winchester Ave., Morgan, UT 84050-9333. Printed in USA. GAC 0909200/09008 Winchester firearms are imported by BACO, Inc. Winchester is a registered trademark of Olin Corporation.



A portion of the sale of every Winchester firearm is proudly donated to the Heritage Fund, which helps to expand the legal defense against politically motivated lawsuits against the hunting and shooting industry. Working together, the rightful tradition of firearms in America will continue.

RED HOT.

2010 MARKS ANOTHER MILESTONE IN THE RICH HISTORY OF WINCHESTER REPEATING ARMS.

The wait for the return of the **Model 1894** is over. America's favorite lever-action gun is back! A High Grade and a Custom-Grade rifle set commemorating Winchester Repeating Arms' founding father, Oliver Fisher Winchester, is offered for 2010. A new Safari Express **Model 70** rifle is in full production, and, as before, is proudly made right here in the USA. With a 1 inch MOA accuracy standard and the innovative M.O.A. Trigger System, it's no wonder the Model 70 was named "Gun of the Year" by *Shooting Industry Academy of Excellence*. Upland fans will love the only production Belgian-made over and under, the **Model 101**. Sporting and Field models are available, as well as the Light with its alloy receiver and lightning fast swing. The **Super X3** is justly famous as the fastest cycling autoloader on the planet and the only shotgun that can keep up with Patrick Flanigan. The **Super X Pump** is a sleek composite pump 12 gauge shotgun built with speed in mind.

Speed. Reliability. Accuracy. Total Performance. Get all this and more from today's **Winchester Repeating Arms**.

WINCHESTERGUNS.COM

PRICES IN U.S. DOLLARS



We proudly support these organizations.



PRSR1 STD
U.S. POSTAGE PAID
PERMIT 315
OGDEN, UT

Winchester Repeating Arms
275 Winchester Ave., Morgan, UT 84050-9333

BLAZING SPEED.



**12 SHOTS
IN 1.442
SECONDS.**

Patrick Flanigan