



WINCHESTER
REPEATING ARMS

2011

WINCHESTER® REPEATING ARMS.®

2011. IT'S A GOOD YEAR TO RIDE THE HORSE.

Other brands may have similar models but they'll never have the history that stands behind the Winchester name. Presented here for 2011 are new guns with an historic lineage, built for the demands of today's shooters, and each is backed by the Winchester reputation for reliability, performance and splendid craftsmanship. Now, as in generations past, the name Winchester continues to be revered like no other.

MODEL 94®



MODEL 94 SHORT RIFLE

MODEL 94 SPORTER

HISTORICAL



MODEL 1886 SHORT RIFLE

MODEL 1892 CARBINE



MODEL 70 FEATHERWEIGHT COMPACT

LOOK FOR NEW CALIBERS:

- Sporter
- Featherweight
- Extreme Weather SS
- Ultimate Shadow

MODEL 70



TABLE OF CONTENTS

MODEL 94®	02-05
TECHNICAL FEATURES	02-03
SPORTER / SHORT RIFLE	04-05
HISTORICAL	06-07
1886 SHORT RIFLE / 1892 CARBINE.....	06-07
MODEL 70®	08-21
TECHNICAL FEATURES	08-09
SUPER GRADE.....	10-11
SAFARI EXPRESS / SPORTER	12-13
FEATHERWEIGHT / FEATHERWEIGHT COMPACT	14-15
EXTREME WEATHER SS	16-17
COYOTE LIGHT	18-19
ULTIMATE SHADOW	20-21
MODEL 101®	22-25
TECHNICAL FEATURES	22-23
SPORTING / PIGEON TRAP / FIELD.....	24-25
SUPER X®3	26-37
TECHNICAL FEATURES	26-27
SPORTING.....	28-29
COMPOSITE / CANTILEVER DEER	30-31
WATERFOWL / ALL-PURPOSE FIELD.....	32-33
NWTF EXTREME TURKEY	34-35
WALNUT FIELD / COMPACT FIELD	36-37
SUPER X® PUMP	38-43
TECHNICAL FEATURES	38-39
WATERFOWL	40-41
BLACK SHADOW FIELD / DEFENDER.....	42-43
ACCESSORIES	44

SXR®



SUPER X3 SPORTING



SUPER X3 NWTF EXTREME TURKEY



SUPER X3 COMPACT FIELD

LOOK FOR THESE NEW 20 GAUGE MODELS:

- Composite
- All-Purpose Field
- Cantilever Deer
- NWTF Extreme Turkey
- Waterfowl

SXP™



SXP WATERFOWL

MODEL 94[®]

NEW MODELS, SAME TIME-TESTED PERFORMANCE.

The most famous lever-action rifle ever produced has returned. Unquestionably, the Winchester[®] Model 94 has been the most favored rifle in history. When John M. Browning happened along in 1893 with a model that was a perfect match for the new 30-30 smokeless cartridge, he ushered in a new era in firearm performance. This is the rifle that made Oliver Fisher Winchester's name known around the world. Haven't cycled a genuine Winchester lever-action legacy lately? There will forever be only one Model 94.



TOP-TANG SAFETY/REBOUNGING HAMMER

The top-tang safety design is easy to see and convenient to operate with the thumb of the firing hand. The rebounding hammer provides an added margin of safety.

WALNUT STOCK

You won't find inferior hardwood on any Winchester[®] Model 94[®] rifle. Stocks and forearms are all first-grade walnut and precision fit.

STEEL LOADING GATE

Loading gates on the Model 94[®] rifles are not stamped out sheet metal, but made from solid steel with radiused edges like the originals. Cartridges are fed easily and dependably into the magazine.

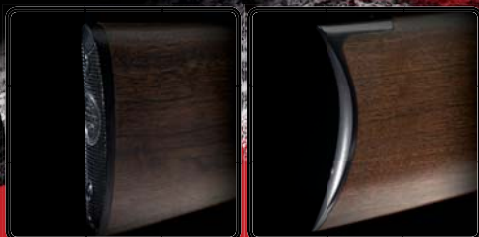

BUTTPLATES

You'll find functional synthetic and traditional crescent buttplates throughout the Model 94[®] line for 2011.



ROUND LOCKING BOLT TRUNNIONS

Round locking bolt trunnions, like the original design, insure smoothness of the entire lever throw. There is little take-up, no hesitation and much less friction. You cycle a smoother, faster lever with less movement and more assurance.

LEVER

Edges of all levers are radiused for a smooth feel. An improved lever slot, not a kidney cut, is closer to the original design for smoother operation.



HAMMER SPUR

A knurled hammer spur aids in cocking and decocking the hammer, especially when a scope is mounted. One is included with every Model 94® that has been drilled and tapped for scope mounts. Simply screw it into the threaded hole in the side of the hammer.



REDUCED HAMMER DRAG

Just like the original Model 94®, the underside of the bolt has a relief cut which helps reduce hammer drag during cocking for smoother operation.



MARBLE ARMS® FRONT SIGHT

Known the world over since 1900 for precision and quality in gun sight design, all Model 94® rifles have a Marble Arms front sight with a brass bead.

ADJUSTABLE REAR SIGHT

The rear sight on all Model 94® rifles is a buckhorn style that's adjustable for windage and elevation.

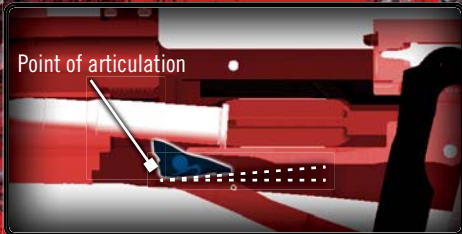

ARTICULATED CARTRIDGE STOP

With today's innovative CNC machining, a new articulated cartridge stop was designed. It insures total reliability without damaging the cartridges, allowing them to cycle directly and smoothly with no misfeeds or double feeds under the carrier. It's designed to provide years of reliable service.

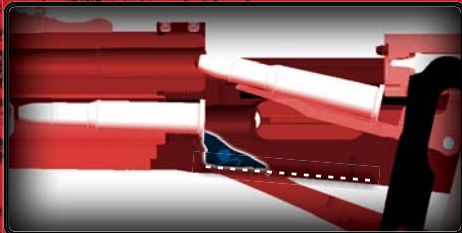

BLUED STEEL FOREARM CAP

A deeply-blued steel forearm cap completes the nostalgic look of the forearm and the overall appearance of the rifle.

BARREL

Barrels on Winchester® Model 94® rifles are button-rifled with a recessed crown. Each barrel is triple checked for ultimate accuracy and precision.

MAGAZINE TUBE

Magazine tubes offer versatility and complement each model with mid-length, button-style and full-length.

MODEL 94[®] CHOOSE YOUR LEVER. TWO NEW MODELS.

Soon after the successful introduction of the Model 94, several new styles and options were offered. Its basic design became a solid, dependable rifle for many different applications and was offered with a variety of barrel styles and lengths, different stocks and fancy models in a wide range of calibers. The Winchester[®] Model 94 has found favor throughout the world. Two new Model 94 rifles are offered for 2011 — a sweet handling Sporter and a handy Short Rifle. Every hunter, shooter and collector should have at least one Model 94. Make one of these genuine Winchester rifles a part of your firearm collection today.



	Item Number	Caliber	Magazine Capacity	Barrel Length	Overall Length	Length of Pull	Drop at Comb	Drop at Heel	Nominal Wt. (lbs.)	Rate of Twist	Sugg. Retail
MODEL 94 SHORT RIFLE (PRICES IN U.S. DOLLARS)											
NEW	534174114	30-30 Win	7	20"	38"	13½"	1¼"	1¾"	6¾"	12"	\$1,129.99
MODEL 94 SPORTER (PRICES IN U.S. DOLLARS)											
NEW	534178114	30-30 Win	8	24"	42½"	13½"	1¼"	1¾"	7½"	12"	\$1,299.99
NEW	534178117	38-55 Win	8	24"	42½"	13½"	1¼"	1¾"	7½"	18"	1,299.99



NEW

SHORT RIFLE

SHORT RIFLE

A favorite of many hunters and shooters, the Short Rifle was fast to the shoulder, quick-swinging, lightweight and a pleasure to shoot. It was a favorite of the range rider who could snatch it from his saddle scabbard and fire faster than prairie lightning. The new Winchester® Model 94® Short Rifle has a compact 20" deeply-blued round barrel and a straight grip walnut stock. It has a rifle-style forearm,

black grip cap and a full-length magazine. It's drilled and tapped for scope mounts, and a hammer spur extension is included with the rifle. The sights are traditional with a semi-buckhorn rear and a Marble Arms® gold bead at the muzzle. With the new Short Rifle Model 94 there's a lot of fun waiting in the saddle, in the field or at the range.



NEW

SPORTER

SPORTER

The new Winchester® Sporter Model 94® is a rifle ready to tickle your shooting fancy. You'll instantly love the traditional straight grip stock with a crescent butt and blued steel buttplate. Note the 24" half-round, half-octagon blued barrel that's reminiscent of the original rifles. The walnut stock is finely checkered in the familiar pattern with

double-lined bordering. The satin oil finish complements the blued receiver which is drilled and tapped for scope mounts. The hammer is drilled and tapped for a spur extension, which is included with the rifle. The Sporter has a semi-buckhorn rear sight and a fine gold bead on the front. This model is available in 30-30 Win. or 38-55 Win.

MODEL 94®

HISTORICAL OWN A CHERISHED FIREARM LEGEND.

Successful firearm designs tend to be preserved and improved through the years. Early guns became legendary because they were efficient and could be depended upon. Today, many still live on with collectors and shooters alike. Winchester Repeating Arms is proud to continue the legacy with three extraordinary lever-action rifles for 2011. The Model 1886™ Short Rifle offers a saddle-worthy rifle that's ideal for elk and deer. Every shooter wants a handy Model 1892™ Carbine. Production on these rifles is limited, so get yours today before they again become history.



	Item Number	Caliber	Magazine Capacity	Barrel Length	Overall Length	Length of Pull	Drop at Comb	Drop at Heel	Nominal Wt. (lbs.)	Rate of Twist	Sugg. Retail
MODEL 1886 SHORT RIFLE (PRICES IN U.S. DOLLARS)											
NEW	534175142	45-70 Govt	8	24"	43"	13¼"	1¼"	2"	8¾	20"	\$1,269.00
MODEL 1892 CARBINE (PRICES IN U.S. DOLLARS)											
NEW	534177141	45 Colt	10	20"	37½"	12¾"	1½"	1¾"	6	26"	\$1,069.99
NEW	534177140	44-40 Win	10	20"	37½"	12¾"	1½"	1¾"	6	36"	1,069.99
NEW	534177124	44 Rem Mag	10	20"	37½"	12¾"	1½"	1¾"	6	26"	1,069.99
NEW	534177137	357 Mag	10	20"	37½"	12¾"	1½"	1¾"	6	18¾"	1,069.99



NEW

MODEL 1886 SHORT RIFLE

MODEL 1886™ SHORT RIFLE

The strong and reliable action of the Winchester® Model 1886 was designed to handle the then-new, heavier 45-70 Govt. cartridge, developed by the U.S. Government in 1873. The Model 1886 Short Rifle features a deeply-blued receiver, barrel and lever, along with a matching blued steel end cap and steel crescent buttplate. The classic straight grip Grade I walnut stock allows quick shouldering, and has an

elegant satin finish. The full-length tubular steel magazine holds six 45-70 Govt. cartridges. The receiver is drilled and tapped for the addition of an optional receiver sight. A top-tang safety, adjustable rear buckhorn style sight and a gold bead Marble Arms® front sight complete the graceful profile of this historic model. Like the other historical rifle models, production is limited.



NEW

MODEL 1892 CARBINE

MODEL 1892™ CARBINE

The Winchester® Model 1892 has been featured in many Western movies and was the favorite of John Wayne and Chuck Connors. It is considered by many as the smoothest, most compact, handiest and most handsome lever-action ever offered. The Model 1892 is the compact model of the venerable Model 1886. For 2011, this

exquisite rifle features a 20" round, deeply-blued and polished barrel, receiver and lever. The full-length tubular magazine balances the rifle perfectly. The stock is solid walnut, cut in a straight grip style for fast handling. It's offered in 45 Colt, 44-40 Win., 44 Rem. Mag., and the versatile 357 Mag.

MODEL 70[®] THE RIFLE AMERICA LOVES.

The Model 70 is the best-known, most respected bolt-action rifle in the world. It is the All-American rifleman's rifle, proudly enduring through the ages and into the future. No other rifle has the reputation or comes as fully equipped with such time-proven features.

THREE-POSITION SAFETY

Convenient to operate with the thumb of your firing hand, the Model 70[®] safety design lifts the firing pin away from the sear. When the safety selector is in the middle position, the action can still be operated, allowing unfired cartridges to be cycled with the safety on. It's smooth to engage and easily identifies the safety status of the rifle.



BLADE-TYPE EJECTOR

A blade-type ejector gives you full control when ejecting a fired case. Pull the bolt back slowly and the empty case pops out gently, perfect for target shooters and varminters. Pull the bolt back smartly and the empty case clears the port with greater force.



STAINLESS STEEL COMPONENTS

The trigger housing and all internal components of the M.O.A. Trigger are constructed of durable, corrosion-resistant stainless steel.

RECOIL PAD

All Model 70[®] rifles (except the Ultimate Shadow) feature a premium Pachmayr[®] Decelerator[®] recoil pad. This ideally contoured pad's contact area offers optimal protection against felt recoil and is quick to your shoulder.



ZERO TAKE-UP

Take-up is the distance the triggerpiece travels prior to the sear moving toward release and the shooter feeling resistance. The M.O.A. Trigger System has no take-up because the take-up spring keeps the triggerpiece in constant contact with the actuator. Unlike competitors' designs, the unique geometry of the M.O.A. pre-loads the entire trigger system to bias-out normal manufacturing tolerances.

ZERO CREEP

Creep is the perceptible movement of the trigger prior to the release of the firing pin and has a negative influence on accuracy because it causes inconsistency and uncertainty during the pull of the trigger. This contributes to jerking the trigger, thus adding to the movement of the gun during firing. The 2:1 mechanical advantage created by the trigger design's unique geometry is how creep has been virtually eliminated in the Model 70[®] M.O.A. Trigger.

ZERO OVERTRAVEL

Overtravel is the rearward movement of the trigger after the firing pin has been released. It can actually jar the gun away from its intended point of aim and is very distracting to the shooter. The Model 70[®] M.O.A. Trigger System is set at the factory to have no perceptible overtravel. Where you aim is where you shoot.

FORGED STEEL RECEIVER

Forged from a solid block of steel, the receiver of the Model 70[®] is not a cost-cutting casting or an extruded blank. Each forging is precision machined to create a strong, stiff and solid receiver that resists flexing and delivers top accuracy for a lifetime of shooting. The bottom profile of the Model 70 receiver is flat to offer more surface area for bedding. It's then bedded, front and rear with a two-part epoxy, eliminating shifts in zero and preserving pinpoint accuracy. The flat bottom contour also resists twisting inside the stock during firing, making it superior to the competitors' round bottom receivers.



CONTROLLED ROUND FEED AND CLAW EXTRACTOR

If there were a single feature responsible for the Model 70[®] being labeled the "Bolt-Action Rifle of the Century," it would be the classic Controlled Round Feed (CRF) bolt design. The massive claw extractor smoothly slips onto and secures about one-quarter of the cartridge's base, exerting full control from the very moment it leaves the magazine and enters the chamber, gripping tightly until it's fully ejected. This time-proven design allows an unfired cartridge to be extracted even if it is not yet fully chambered.

TARGET CROWN

Every Model 70[®] features a recessed target crown at the muzzle to protect the rifling from nicks and dings. Each bullet exits the barrel uniformly, with ultimate precision.



INTEGRAL RECOIL LUG

The recoil lug on the Model 70[®] is actually forged and machined as part of the receiver. It's not a separate part that's installed between the barrel and the action during assembly. This allows the barrel to be trued in perfect alignment to the front ring of the receiver for greater accuracy. There is nothing to move or shift the barrel out of alignment, ever.

COLD HAMMER-FORGED, FREE-FLOATING BARREL

A critical feature of any high-powered rifle is how the barrel is made and set in the stock. Every Model 70[®] barrel is cold hammer-forged from a solid billet of steel, shaped by massive rotary hammers over a mandrel to create the rifling. Then each barrel is stress relieved to ensure top accuracy, even during the heat of long strings of fire. The Model 70 barrel is free-floating in the stock so that no part of the fore-end touches the barrel, because pressure from the stock can adversely influence accuracy. You can expect 1 MOA accuracy for three-shot groups from your Model 70 using premium ammo and quality optics under suitable weather and range conditions.

WALNUT STOCK

Only a precisely fit, solid American walnut stock enhanced with finely cut checkering is appropriate for a rifle living up to a rich legacy of accuracy and dependability like the Model 70[®].



ONE-PIECE BOTTOM METAL

The trigger guard and magazine frame of each Model 70[®] feature a solid, one-piece bottom metal floorplate that bridges and supports the action through the magazine well. This added rigidity contributes to accuracy and integrity better than two-piece or plastic systems. The hinged magazine floorplate speeds unloading of the cartridges, avoiding having to cycle them through the action. The action and trigger guard are held in place by stout hex head screws.



BUILT IN THE USA

The All-American Model 70[®] is built by American craftsmen in Columbia, South Carolina. This is the same state-of-the-art factory where the rifles and machine guns used by America's Armed Forces around the world are built. They are made to the exact ISO 9001 standard of quality that Uncle Sam insists upon for military firearms.

MODEL[®] 70

MODEL 70[®] HERE'S YOUR BOLT-ACTION RIFLE.

The enhanced sporter-style stock of the Model 70 has been trimmed for better handling and ideal balance. A shadowline cheekpiece quickly aligns your eye with your scope. Highly polished, deeply blued steel and finely checkered fancy grade walnut define the style of the Super Grade Model 70 rifle. Don't settle for second best.

M.O.A.[™]
TRIGGER SYSTEM

ISO 9001
QUALITY



Item Number	Caliber	Magazine Capacity	Barrel Length	Overall Length	Length of Pull	Drop at Comb	Drop at Heel	Nominal Wt. (lbs.)	Rate of Twist	Sugg. Retail
MODEL 70 SUPER GRADE (PRICES IN U.S. DOLLARS)										
535107264	270 WSM	3	24"	44¾"	13¾"	½"	½"	8	10"	\$1,379.99
535107255	300 WSM	3	24"	44¾"	13¾"	½"	½"	8	10"	1,379.99
535107226	270 Win	5	24"	44¾"	13¾"	½"	½"	8¼	10"	1,329.99
535107228	30-06 Sprg	5	24"	44¾"	13¾"	½"	½"	8¼	10"	1,329.99
535107233	300 Win Mag	3	26"	46¾"	13¾"	½"	½"	8½	10"	1,379.99
535107236	338 Win Mag	3	26"	46¾"	13¾"	½"	½"	8½	10"	1,379.99

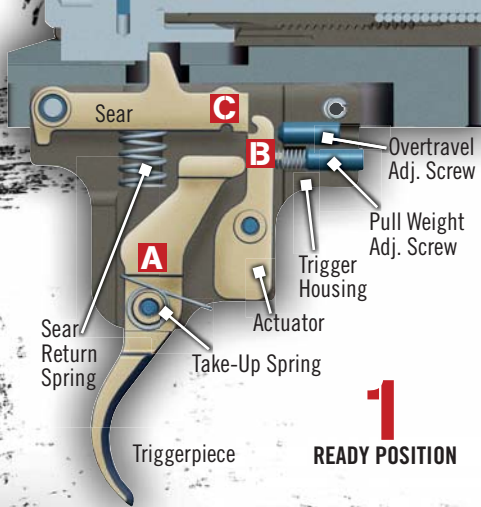

1
READY POSITION

1) M.O.A. TRIGGER SYSTEM. The Model 70[®] M.O.A. Trigger System works on the simple principle of the pivoting lever. Pictured left are the triggerpiece (A), actuator (B), and sear (C). The housing and all internal parts, pins and springs are precision crafted from stainless steel. The sear and actuator are Slick Shot[®] electroless nickel Teflon[®] coated for corrosion resistance and smoother operation. It's easily adjusted.

2) 2:1 MECHANICAL ADVANTAGE. The M.O.A.'s triggerpiece (right) offers a wide, smooth face to better distribute finger pressure for a lighter, more sensitive feel. Because of the M.O.A. Trigger's geometry and 2:1 mechanical advantage, as the triggerpiece moves rearward (X), it travels only half the distance of the actuator (2X). Since this distance is greatly decreased, the perception of creep and overtravel are virtually eliminated.

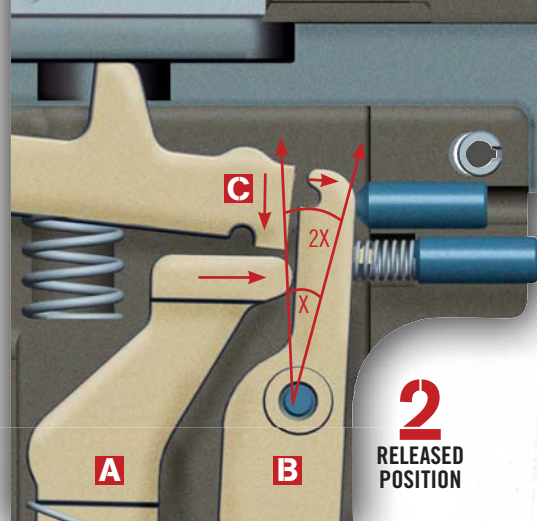

2
RELEASED POSITION



LEFT SIDE VIEW

SUPER GRADE

SUPER GRADE

From Africa's Botswana to the Brooks Range in Alaska, no other rifle has traveled so extensively in search of big game or is held in such high esteem as the Model 70[®]. Foremost in the series is the elegant Super Grade. The warm grain and figure of the fancy grade walnut stock with finely cut checkering complement the contrasting black fore-end tip and pistol grip cap. The sleek lines of the sculpted shadowline cheekpiece flow across the stock. A blued steel stock crossbolt adds strength and elegance and is tastefully engraved. Inletted blued steel swivel studs grace

the underside. A black Pachmayr[®] Decelerator[®] pad helps soften felt recoil. The cold hammer-forged steel barrel is free floating for enhanced accuracy. The M.O.A.[™] Trigger System puts the Super Grade under your total control. With no take-up, no creep and no overtravel, it's the finest trigger ever offered and will immediately help you realize the gun's 1 MOA accuracy potential. When you're ready for super accuracy combined with super performance, you're ready for the Model 70 Super Grade. (Scope and mounting system not included.)



SHADOWLINE CHEEKPIECE. The Model 70[®] Super Grade cheekpiece is beautifully functional, placing your eye in perfect alignment behind either open sights or a scope.



ONE-PIECE STEEL BOTTOM METAL. Adds extra rigidity to the stock and action for improved accuracy.

- M.O.A.[™] Trigger System
- Three-position safety
- Controlled Round Feeding
- Satin-finished, fancy grade walnut stock
- Hex socket action screws
- One-piece steel trigger guard and flush-mount hinged magazine floorplate

MODEL[®]
70

MODEL 70[®] PLAN YOUR DREAM HUNT.

It's every hunter's dream to visit Africa. Big game hunters lucky enough to experience a safari to the Dark Continent must be prepared with a reliable rifle of the proper caliber and a proven action you can trust your life to. Don't consider hunting with anything else than the Winchester[®] Model 70 Safari Express big game rifle. This is the model that is built to handle the punishment from heavy, game-stopping cartridges. Still the smoothest action in any rifle, the External Claw Extractor consistently secures and ejects every cartridge, every time. Take no chances on any other brand. The Winchester Model 70 is the rifle you take on the safari of a lifetime.



SPORTER

The Sporter features a satin finish Grade I walnut stock with cut checkering on its trim fore-end and pistol grip, along with a sculpted cheekpiece for precise scope alignment to create a superbly balanced rifle that's easy to carry. The premium Pachmayr[®] Decelerator[®] recoil pad offers optimal protection against felt recoil while still being quick to your shoulder. Along with the Sporter's great looks and handling come a cold hammer-forged barrel and the crisp three-lever M.O.A.[™] Trigger System that let you fully exploit the 1 MOA accuracy potential of this classic hunting rifle. It's available in popular long and short action calibers including WSM chamberings.



The sculpted cheekpiece on the Model 70[®] Sporter.

SAFARI EXPRESS

The Model 70® Safari Express in a matte blued finish is the perfect choice for your once-in-a-lifetime hunt because it's built to handle the heavy cartridges necessary to take dangerous game. Its proven reliability and rugged, fail-proof reputation mean it's the only rifle to consider. It features important details like the Pre-'64 type claw extractor, Pachmayr® Decelerator® recoil pad, barrel band front swivel base, hooded-blade front sight and express-style rear sight. The dual recoil lugs and two steel stock reinforcing crossbolts handle the punishment from heavy magnum

loads. The time-tested three-position safety has been a hallmark of the Model 70 for decades. The secure hex socket action screws won't snag on clothing, and the one-piece steel trigger guard helps maintain rigidity and provides added strength. The handsome cheekpiece positions your eye instantly and firmly on target. Flip open the flush-mounted, hinged, solid steel magazine floorplate for fast and easy unloading. Your favorite caliber is available, making the Model 70 Safari Express the finest big game rifle in the world.



SAFARI EXPRESS



DOUBLE LUG STRENGTH. Adds strength to the stock and action for improved accuracy.



DELUXE CHEEKPIECE. The Model 70® Safari Express cheekpiece is beautifully functional, placing your eye in perfect alignment behind either open sights or a scope.



TWO CROSS BOLTS. Adds extra rigidity to the stock and action for improved accuracy. The Model 70® Safari Express also features a solid, one-piece steel bottom metal and steel floorplate.



SPORTER

Item Number	Caliber	Magazine Capacity	Barrel Length	Overall Length	Length of Pull	Drop at Comb	Drop at Heel	Nominal Wt. (lbs.)	Rate of Twist	Sugg. Retail
MODEL 70 SAFARI EXPRESS (PRICES IN U.S. DOLLARS)										
535116161	375 H&H Mag	3	24"	44¾"	13¾"	½"	½"	9	12"	\$1,349.99
535116139	416 Rem Mag	3	24"	44¾"	13¾"	½"	½"	9	14"	1,349.99
535116144	458 Win Mag	3	24"	44¾"	13¾"	½"	½"	9	14"	1,349.99
MODEL 70 SPORTER (PRICES IN U.S. DOLLARS)										
535108264	270 WSM	3	24"	44¼"	13¾"	½"	½"	7¼	10"	\$949.99
535108255	300 WSM	3	24"	44¼"	13¾"	½"	½"	7¼	10"	949.99
535108277	325 WSM	3	24"	44¼"	13¾"	½"	½"	7¼	10"	949.99
NEW 535108225	25-06 Rem	5	24"	44¾"	13¾"	½"	½"	7¼	10"	899.99
535108226	270 Win	5	24"	44¾"	13¾"	½"	½"	7¼	10"	899.99
535108228	30-06 Sprg	5	24"	44¾"	13¾"	½"	½"	7¼	10"	899.99
535108230	7mm Rem Mag	3	26"	46¾"	13¾"	½"	½"	7¼	9½"	949.99
535108233	300 Win Mag	3	26"	46¾"	13¾"	½"	½"	7¼	10"	949.99
535108236	338 Win Mag	3	26"	46¾"	13¾"	½"	½"	7¼	10"	949.99

- M.O.A.™ Trigger System
- Three-position safety
- Controlled Round Feeding
- Satin-finished checkered walnut stock
- Hex socket action screws
- One-piece steel trigger guard and flush-mount hinged magazine floorplate
- Two steel crossbolts on Safari Express
- Matte blued finish

MODEL 70[®] YOUR FAVORITE MODEL 70.

The superb craftsmanship and reputation of the Model 70 live on in the Featherweight and new Featherweight Compact models. From deer to varmints, hogs to antelope, these all-around rifles are well suited for any type of game because of their lightweight, fast handling, soft recoil and smooth, dependable cycling. No other company builds a rifle that compares to the Winchester[®] Model 70.



FEATHERWEIGHT COMPACT

The new Featherweight Compact carries on the Model 70[®] Featherweight heritage in a deluxe, refined model that is an excellent choice for smaller-framed shooters, ladies, young people or hunters who prefer a compact, light mountain rifle. Its comfortable, smaller platform instills confidence in shooters because it fits them better than a full-sized rifle. The Compact Model 70 action has Pre-'64 Controlled Round Feeding, the easy-to-use three-position safety and

a jeweled bolt body with knurled bolt handle. The M.O.A.[™] Trigger System is easily adjustable and has no take-up, creep or overtravel. This new Featherweight Compact with its 20" barrel and fast, flat-shooting calibers starts young shooters off right with a rifle possessing all the deluxe features of the Featherweight. It's a rifle to train with, hunt with, have fun with and pass down to the next generation.



All Model 70 rifles feature free-floating barrels.



FEATHERWEIGHT

FEATHERWEIGHT

The legendary handling and quickness of the Model 70® Featherweight is justly famous among hunters everywhere. The Model 70 action offers Pre-'64 style Controlled Round Feeding, a three-position safety and is highlighted by a jeweled bolt body with knurled bolt handle. Inside is the M.O.A.™ Trigger System, the finest trigger ever offered in a bolt-action with zero take-up, zero creep and zero overtravel.

Like the original Featherweight, the elegantly cut, checkered walnut stock still features the Schnabel fore-end and satin finish. A premium Pachmayr® Decelerator® pad helps soak up felt recoil. The Model 70 Featherweight is available in the most popular long action and short action calibers, including WSM chamberings.



NEW

FEATHERWEIGHT COMPACT

Item Number	Caliber	Magazine Capacity	Barrel Length	Overall Length	Length of Pull	Drop at Comb	Drop at Heel	Nominal Wt. (lbs.)	Rate of Twist	Sugg. Retail	
MODEL 70 FEATHERWEIGHT (PRICES IN U.S. DOLLARS)											
	535109210	22-250 Rem	5	22"	42¼"	13¾"	½"	¾"	6¾"	14"	\$899.99
	535109212	243 Win	5	22"	42¼"	13¾"	½"	¾"	6¾"	10"	899.99
	535109218	7mm-08 Rem	5	22"	42¼"	13¾"	½"	¾"	6¾"	9½"	899.99
	535109220	308 Win	5	22"	42¼"	13¾"	½"	¾"	6¾"	12"	899.99
	535109264	270 WSM	3	24"	44¼"	13¾"	½"	¾"	7"	10"	949.99
	535109255	300 WSM	3	24"	44¼"	13¾"	½"	¾"	7"	10"	949.99
	535109277	325 WSM	3	24"	44¼"	13¾"	½"	¾"	7"	10"	949.99
NEW	535109225	25-06 Rem	5	22"	42¾"	13¾"	½"	¾"	7"	10"	899.99
	535109226	270 Win	5	22"	42¾"	13¾"	½"	¾"	7"	10"	899.99
	535109228	30-06 Sprg	5	22"	42¾"	13¾"	½"	¾"	7"	10"	899.99
	535109233	300 Win Mag	3	24"	44¾"	13¾"	½"	¾"	7¼"	10"	949.99
MODEL 70 FEATHERWEIGHT COMPACT (PRICES IN U.S. DOLLARS)											
NEW	535126210	22-250 Rem	5	20"	39½"	13"	½"	¾"	6½"	14"	\$899.99
NEW	535126212	243 Win	5	20"	39½"	13"	½"	¾"	6½"	10"	899.99
NEW	535126218	7mm-08 Rem	5	20"	39½"	13"	½"	¾"	6½"	9½"	899.99
NEW	535126220	308 Win	5	20"	39½"	13"	½"	¾"	6½"	12"	899.99

- Satin-finished checkered walnut stocks
- Controlled Round Feeding
- Bedded actions and free-floating barrels for exceptional long-range accuracy
- M.O.A.™ Trigger System
- Pachmayr® Decelerator® pads

MODEL 70[®] EXTREME WEATHER.

Extreme conditions demand performance you can count on from your hunting rifle, and this rifle can take it. The Model 70 Extreme Weather SS (Stainless Steel) is a ruggedly built rifle that will put your game down. The M.O.A.[™] Trigger System, Pre-'64 type Controlled Round Feed bolt with claw extractor and three-position safety offer absolute control over every shot. The Extreme Weather SS's textured synthetic Bell and Carlson[™] stock with sculpted cheekpiece is a high-performance design. When you hunt with the Winchester[®] Model 70 Extreme Weather SS, you'll experience the ultimate in pinpoint accuracy and extreme weather-resistant durability.



	Item Number	Caliber	Magazine Capacity	Barrel Length	Overall Length	Length of Pull	Drop at Comb	Drop at Heel	Nominal Wt. (lbs.)	Rate of Twist	Sugg. Retail
MODEL 70 EXTREME WEATHER SS (PRICES IN U.S. DOLLARS)											
	535110212	243 Win	5	22"	42¼"	13¾"	½"	½"	6¾	10"	\$1,179.99
NEW	535110218	7mm-08 Rem	5	22"	42¼"	13¾"	½"	½"	6¾	9½"	1,179.99
	535110220	308 Win	5	22"	42¼"	13¾"	½"	½"	6¾	12"	1,179.99
	535110264	270 WSM	3	24"	44¼"	13¾"	½"	½"	7	10"	1,229.99
	535110255	300 WSM	3	24"	44¼"	13¾"	½"	½"	7	10"	1,229.99
	535110277	325 WSM	3	24"	44¼"	13¾"	½"	½"	7	10"	1,229.99
NEW	535110225	25-06 Rem	5	22"	42¾"	13¾"	½"	½"	7⅞	10"	1,179.99
	535110226	270 Win	5	22"	42¾"	13¾"	½"	½"	7⅞	10"	1,179.99
	535110228	30-06 Sprg	5	22"	42¾"	13¾"	½"	½"	7⅞	10"	1,179.99
	535110230	7mm Rem Mag	3	26"	46¾"	13¾"	½"	½"	7¼	9½"	1,229.99
	535110233	300 Win Mag	3	26"	46¾"	13¾"	½"	½"	7¼	10"	1,229.99
	535110236	338 Win Mag	3	26"	46¾"	13¾"	½"	½"	7¼	10"	1,229.99

CROSS SECTION OF STOCK WITH ALUMINUM BEDDING BLOCK

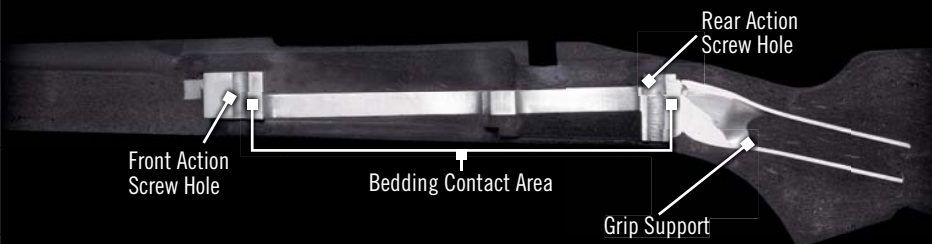

TOP VIEW OF ALUMINUM BEDDING BLOCK

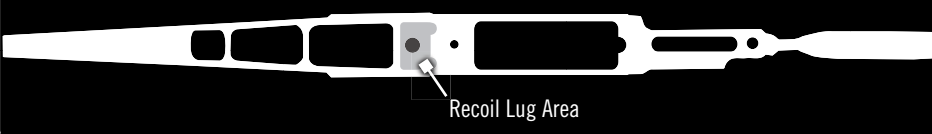

ALUMINUM BEDDING BLOCK. The Extreme Weather SS is bedded into an alloy skeletal bedding block that's molded right into the stock during manufacturing. The precise mating of this bedding block to the lower portion of the receiver means flat-out reliability. The rifle holds a tight zero, putting the first shot and every shot that follows right where you expect, in any weather condition, season after season.

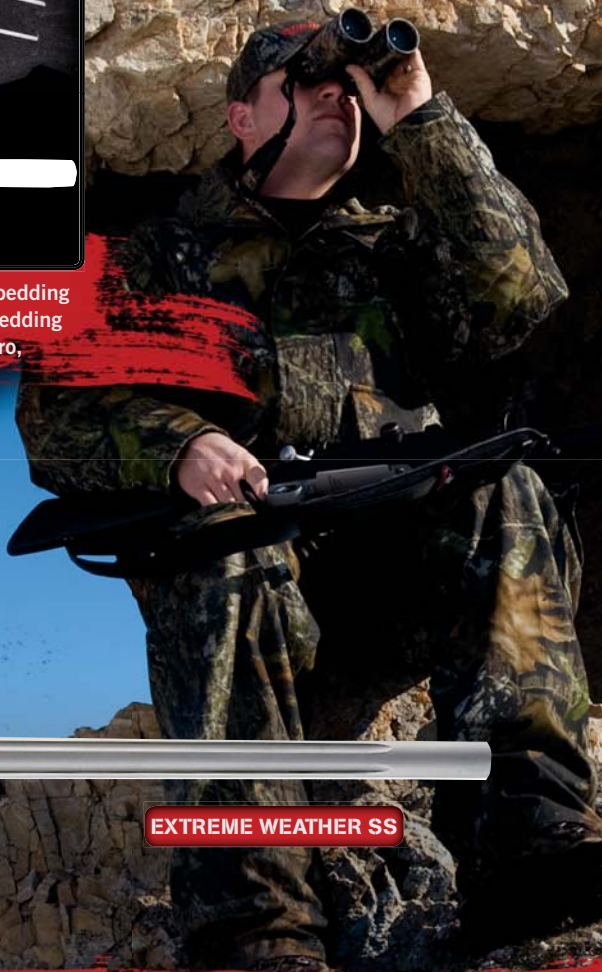

EXTREME WEATHER SS

EXTREME WEATHER SS

Get extreme accuracy under any conditions. The Bell and Carlson™ composite stock provides a solid feel and features trim, lightweight ergonomics. It has a textured charcoal gray matte finish for rugged good looks and improved grip in adverse conditions. The sculpted cheekpiece helps insure proper eye-to-scope alignment from any shooting position. The thick, black Pachmayr® Decelerator® pad helps take the felt recoil out of high performance magnum cartridges. The Extreme Weather SS rifle's free-floating, fluted stainless steel barrel has a recessed target crown and is made in the same factory as those used in our U.S. military rifles and machine guns. With quality optics, premium ammunition and good shooting conditions, 1 MOA accuracy can be expected. Two stainless steel sling swivel studs are installed. (Scope and mounting system not included.)

- M.O.A.™ Trigger System
- Controlled Round Feeding
- Three-position safety
- Bell and Carlson™ premium composite stock
- Hex socket action screws
- One-piece trigger guard and hinged magazine floorplate

**MODEL®
70**

MODEL 70[®] CRANK UP YOUR CALLER.

When the loping form of a wily coyote sends your thumb to the rifle safety, and the anticipation of getting a shot sharpens all your senses, you need a rifle that is stable from buttstock to muzzle, highly accurate and totally reliable. The Coyote Light is the rifle you need if you're a serious varmint hunter or want the ideal crossover rifle for deer, antelope and other big game. Its perfect range of varmint and hunting calibers and lighter weight make it easy to carry or set up in a blind or on a bipod.



COYOTE LIGHT

Varmint guns are usually recognized by their heavier barrels, bipod mounting studs and long-range scopes, but they are far from being equal. The Coyote Light rifle has been carefully trimmed of any unnecessary bulk but is no lightweight when it comes to performance. Mating the bedding block to the receiver equals total stability, reliability and outstanding accuracy. The matte-blued receiver and medium-heavy fluted stainless barrel create tack-driving accuracy. The Bell and Carlson[™] composite

stock provides a solid feel and features trim and lightweight ergonomics. It has a textured charcoal gray matte finish for rugged good looks and improved grip in adverse conditions. Flow-through vents on the fore-end reduce weight and help cool the barrel during long strings of fire. A Pachmayr[®] Decelerator[®] pad soaks up recoil. Three blued sling swivel studs are installed. Available in standard short action and WSM calibers. (Scope and mounting system not included.)



ALUMINUM BEDDING BLOCK. Like the Model 70® Extreme Weather SS, the Coyote Light's receiver is bedded into an alloy skeletal bedding block molded into the stock. Mating the bedding block to the receiver equals total stability, reliability and outstanding accuracy.



COYOTE LIGHT

- **Controlled Round Feeding**
- **Bedded action and free-floating barrel for exceptional long-range accuracy**
- **M.O.A.™ Trigger System**
- **Pachmayr® Decelerator® pad**
- **Bell & Carlson™ stock with embedded aluminum block for added strength and superb accuracy**

Item Number	Caliber	Magazine Capacity	Barrel Length	Overall Length	Length of Pull	Drop at Comb	Drop at Heel	Nominal Wt. (lbs.)	Rate of Twist	Sugg. Retail
MODEL 70 COYOTE LIGHT (PRICES IN U.S. DOLLARS)										
535115210	22-250 Rem	5	24"	44"	13½"	½"	½"	7½	14"	\$1,099.99
535115212	243 Win	5	24"	44"	13½"	½"	½"	7½	10"	1,099.99
535115220	308 Win	5	24"	44"	13½"	½"	½"	7½	12"	1,099.99
535115264	270 WSM	3	24"	44"	13½"	½"	½"	7½	10"	1,149.99
535115255	300 WSM	3	24"	44"	13½"	½"	½"	7½	10"	1,149.99
535115277	325 WSM	3	24"	44"	13½"	½"	½"	7½	10"	1,149.99

MODEL 70[®] BEAUTIFUL IN BLACK.

The Model 70 Ultimate Shadow[®] does not have your run-of-the-mill, cookie-cutter synthetic stock. This stock's material and design are the most advanced in the industry. Every contour and ridge, plus the fitting of stock-to-steel are carefully engineered to provide maximum strength and efficiency with minimum weight. If you're looking for an all-weather synthetic stock rifle that's not just another "black gun" grab a Model 70 Ultimate Shadow. Its name says it all.



Item Number	Caliber	Magazine Capacity	Barrel Length	Overall Length	Length of Pull	Drop at Comb	Drop at Heel	Nominal Wt. (lbs.)	Rate of Twist	Sugg. Retail	
MODEL 70 ULTIMATE SHADOW (PRICES IN U.S. DOLLARS)											
	535114212	243 Win	5	22"	42"	13½"	⅜"	⅜"	6¼	10"	\$799.99
NEW	535114218	7mm-08 Rem	5	22"	42"	13½"	⅜"	⅜"	6¼	9½"	799.99
	535114220	308 Win	5	22"	42"	13½"	⅜"	⅜"	7	12"	799.99
	535114264	270 WSM	3	24"	44"	13½"	⅜"	⅜"	7	10"	849.99
	535114255	300 WSM	3	24"	44"	13½"	⅜"	⅜"	7	10"	849.99
	535114277	325 WSM	3	24"	44"	13½"	⅜"	⅜"	7	10"	849.99
NEW	535114225	25-06 Rem	5	24"	44¾"	13¾"	⅜"	⅜"	7	10"	799.99
	535114226	270 Win	5	24"	44¾"	13¾"	⅜"	⅜"	7	10"	799.99
	535114228	30-06 Sprg	5	24"	44¾"	13¾"	⅜"	⅜"	7	10"	799.99
	535114230	7mm Rem Mag	3	26"	46¾"	13¾"	⅜"	⅜"	7¼	9½"	849.99
	535114233	300 Win Mag	3	26"	46¾"	13¾"	⅜"	⅜"	7¼	10"	849.99
	535114236	338 Win Mag	3	26"	46¾"	13¾"	⅜"	⅜"	7¼	10"	849.99



WinSorb™
TECHNOLOGY

WINSORB™ TECHNOLOGY. The Model 70® Ultimate Shadow® has a WinSorb recoil pad, specifically designed for Ultimate Shadow composite stocks. Like the finest gel pad, it cushions and absorbs sharp recoil, allowing more pleasant shooting at the bench, especially with heavy magnum calibers.

CLASSIC EXTERNAL CLAW EXTRACTOR. The massive external claw extractor smoothly captures nearly one quarter of the base of the cartridge as it releases from the magazine, allowing the bolt to fully control feeding into and guarantee extraction from the chamber.



ULTIMATE SHADOW

ULTIMATE SHADOW®

At first glance, the Model 70® Ultimate Shadow, with its flowing lines and integrated, rubberized, oval-dot gripping surfaces on the pistol grip and fore-end looks very different from other composite rifles. When you pick it up, you'll know why. The stock immediately gives you a comfortable, secure hold even when wet or cold. It feels tailor-made for your hands and gives you better control from any shooting position. The Ultimate Shadow is lightweight so you can carry it into remote, rugged country without undue fatigue. The free-floating barrel and M.O.A.™ Trigger System contribute to exceptional accuracy and its classic Controlled Round Feed action makes the Ultimate Shadow the most reliable and smoothest cycling rifle in the industry. It's offered with a 22", 24" or 26" blued barrel and is available in popular standard and long magnum calibers, plus three WSM calibers.

- **Controlled Round Feeding**
- **Bedded action and free-floating barrel for exceptional long-range accuracy**
- **M.O.A.™ Trigger System**
- **WinSorb™ recoil pad**
- **Lightweight**



MODEL™
70

MODEL 101[®] HAVE A FIELD DAY.

If you are considering a new Winchester[®] Model 101 over and under shotgun, the “Made in Belgium” stamped on its upper barrel is a good start. Its super-strong action was tested by firing 25,000 shells without a single part failure. The specially designed low-profile receiver moves your hands and eyes closer to the bore centerline for faster target acquisition with less felt recoil, making the Model 101 extremely pleasant to shoot all day. Compare its features with other over and unders and you’ll know you want a Winchester Model 101.

FAMILIAR DIMENSIONS

Today’s Model 101[®] features the same dimensions set long ago by the original. The familiar drop at comb and narrow, comfortable grip ensure time-tested levels of comfort and performance.



LOW-PROFILE RECEIVER

The Model 101[®] has the drop on the original with the advantage of a low-profile receiver. This means that recoil occurs in-line, directly back for faster follow-up shots with less muzzle jump. Also, your forward hand can be closer to the bore centerline, bringing your hands, face and sighting plane into a more natural alignment for more intuitive and accurate shooting.

ADJUSTABLE COMB

An adjustable comb stock allows you to modify individual height and cast on/off custom fitting in just seconds. (Hex key wrench is included.)



CUT CHECKERING

Every Model 101[®] has finely cut checkering to improve grip and add artistic elegance to the walnut stock and forearm.

ADJUSTABLE TRIGGER

Fine tune your precise length of pull for more comfortable shooting on Pigeon models with the easily adjustable trigger. (Hex key wrench is included.)



PACHMAYER[®] DECELERATOR[®] RECOIL PAD

Getting pounded by your gun is now a thing of the past with the patented Pachmayr Decelerator recoil pad with snag-free heel. It’s found on all Model 101[®] shotguns. It reduces felt recoil to very manageable levels, even when shooting heavy magnum loads.

GRIP CAP

Sporting and Field models have an elegant fitted grip cap.

BACK-BORED TECHNOLOGY

.742" BACK-BORED TECHNOLOGY

Extensive research and testing has proven that when it comes to back-boring, .742" is the ideal 12 gauge interior barrel diameter, ensuring tight, consistent patterns. Any larger and gases blow by the shot cup and reduce pellet velocity. Too tight and the pellets are deformed as they pass through the forcing cone, causing poor ballistic performance.

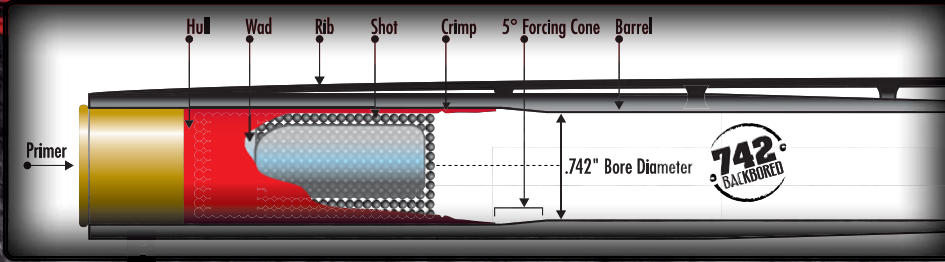

INVECTOR-PLUS™ CHOKES

From the duck blind to the firing line, the Invector-Plus choke tube system is the world's favorite. All Model 101® shotguns come with either extended Signature or flush-mounted tubes, depending on the model. Additional tubes are available at your local Winchester Repeating Arms dealer.

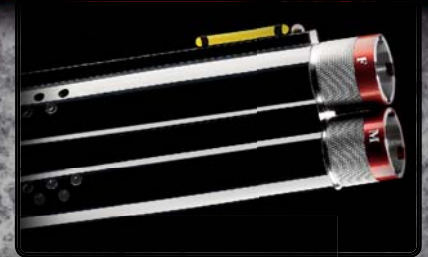

TRUGLO

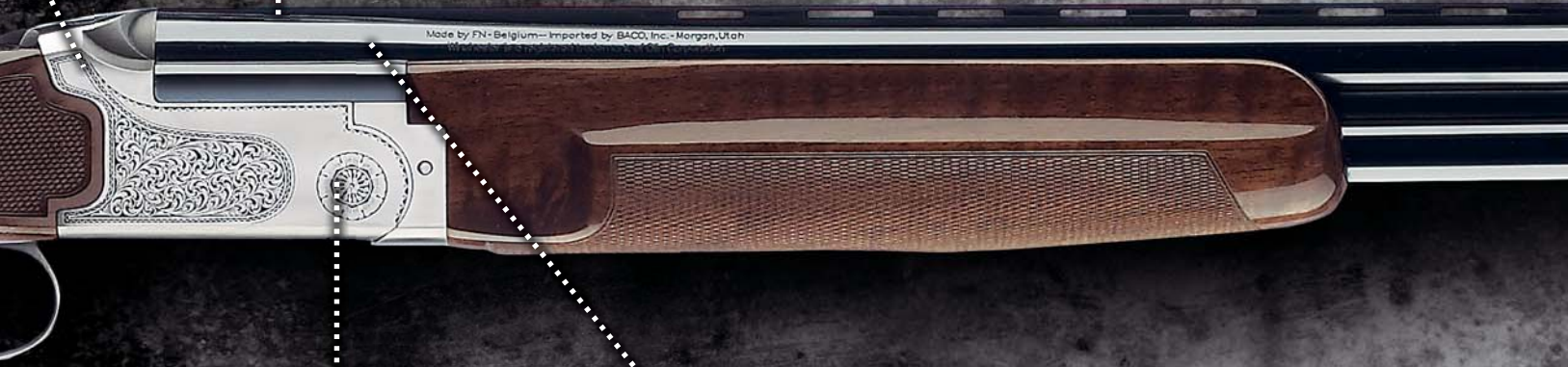

STEEL-TOUGH HINGE

All hinge areas bear tension from recoil with each shot, so the Model 101® is built with surfaces that are 49% larger than many competitors. The surfaces are machined simultaneously with the hinge to ensure perfect alignment.



CHROME PLATED CHAMBERS AND BORES

All Winchester® Model 101® shotguns have chrome-plated chambers and bores that stand up to the abuse thousands of shells can make. Corrosion resistance is also greatly improved.



LOCKING LUGS

The locking lugs have 30% more contact surface than the competition for an action that's the strongest in the industry and built to last!

M O D E L 1 0 1

WINCHESTER

MODEL 101[®] SWING WITH PERFORMANCE.

Serious hunters and those who love shooting trap, skeet or sporting clays, realize that a comfortable shotgun is critical for success and increases your fun. Winchester[®] Model 101 shotguns feature a low-profile receiver that places your hands and eyes closer to the centerline of the bore, giving you faster target acquisition with less felt recoil. This feature is very important, and means a more comfortable swing with greater success and more hits. Fill your game bag and boost your scores with a Winchester Model 101.



BACK-BORED TECHNOLOGY **TRUGLO** **SPORTING**

MODEL 101[®] SPORTING

The family of Winchester[®] Model 101 over and under shotguns are the finest guns on the market in both looks, feel and construction. The Sporting includes a long list of high-performance features modern target shooters demand, like the Invector-Plus™ choke tube system with five extended Signature tubes (Light-Full, Improved Modified, Modified, Improved Cylinder and Skeet) and .742" Back-Bored Technology to provide optimum shot patterns. The richly blued receiver and authentic engraving are framed by high-gloss Grade II walnut. Lightweight ported barrels and the finest Pachmayr[®] Decelerator[®] sporting pad help control recoil. A 10mm machined runway rib, white mid-bead and TRUGLO[®] front sight round out this feature-packed shotgun. A rugged molded ABS hard case is included.



T-Wrench, LF, IM, M, IC, SK

	Item Number	Gauge	Barrel Length	Chamber	Choke Tubes Included	Overall Length	Length of Pull	Drop at Comb	Drop at Heel	Nominal Wt. (lbs.)	Sugg. Retail
MODEL 101 PIGEON TRAP (PRICES IN U.S. DOLLARS)											
	513057493	12	30"	2¾"	XF, F, IM	47½"	14½"	1½"	2¾"	7½	\$2,349.99
	513057494	12	32"	2¾"	XF, F, IM	49½"	14½"	1½"	2¾"	7½	2,349.99
MODEL 101 PIGEON TRAP (ADJUSTABLE COMB) (PRICES IN U.S. DOLLARS)											
	513059493	12	30"	2¾"	XF, F, IM	47½"*	14½"	1½"	2¾"	7½	\$2,499.99
	513059494	12	32"	2¾"	XF, F, IM	49½"*	14½"	1½"	2¾"	7½	2,499.99
MODEL 101 SPORTING (PRICES IN U.S. DOLLARS)											
	513054492	12	28"	2¾"	LF, IM, M, IC, SK	45½"	14½"	1¾"	2¾"	7½	\$2,199.99
	513054493	12	30"	2¾"	LF, IM, M, IC, SK	47½"	14½"	1¾"	2¾"	7¼	2,199.99
	513054494	12	32"	2¾"	LF, IM, M, IC, SK	49½"	14½"	1¾"	2¾"	7½	2,199.99
MODEL 101 FIELD (PRICES IN U.S. DOLLARS)											
	513046371	12	26"	3"	F, M, IC	43¼"	14¼"	1¾"	2¾"	6¾	\$1,789.99
	513046361	12	28"	3"	F, M, IC	45¼"	14¼"	1¾"	2¾"	7	1,789.99

*Adjustable comb stock dimensions are measured with comb in a mid-position.

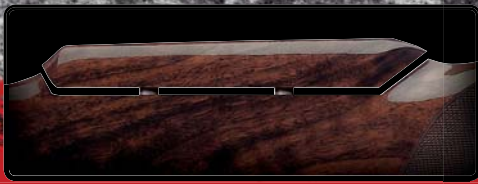

The Model 101® Pigeon Trap is available with an adjustable comb stock.



Every Model 101® Sporting/Trap shotgun comes with a durable, fitted ABS hard case embossed with the Winchester® logo.



BACK-BORED TECHNOLOGY

TRUGLO

PIGEON TRAP



T-Wrench, XF, F, IM



MODEL 101® PIGEON TRAP

When you step into a shooting station, you need an over and under that is quick to shoulder and points naturally. In other words, a gun that shoots with you and imparts confidence with every bird pulled. The Model 101 Pigeon Trap has all the features you need to shoot better. The 10mm wide steel runway rib, mid-bead sight and TRUGLO® TRU-BEAD® interchangeable fiber-optic front sight offer a true, precise and more technical sight picture. The lightweight barrels are highly polished with porting and vented side ribs. An adjustable trigger shoe fine tunes your length of pull. Select from models with a fixed comb, or with an adjustable comb that allows individual height and cast on/off custom fitting in just seconds. All stocks are carved from beautiful high-gloss Grade II/III walnut. The Pigeon Trap also features the world-famous Invector-Plus™ choke tube system, .742" Back-Bored Technology and comes with the extended Signature Extra-Full, Full and Improved Modified choke tubes. A rugged molded ABS hard case is included.



BACK-BORED TECHNOLOGY

FIELD



F, M, IC

MODEL 101® FIELD

The experience of handling a much more expensive over and under is what you'll find with the very affordable Model 101 Field. A high-gloss Grade II/III walnut stock with classic dimensions and a trim grip provide a total performance fit, complemented by the elegance of a deep-relief engraved, low-profile steel receiver. A Pachmayr® Decelerator® recoil pad with a no-snap heel insert is standard. Lightweight profile barrels swing fast, and open and close with tight precision. The Invector-Plus™ choke tube system (Full, Modified and Improved Cylinder) and .742" Back-Bored Technology provide optimum patterning. With a Model 101 Field, the superlative performance of an over and under field gun is yours, and has never been so affordable.

MODEL 101®

SUPER X[®]3 STILL THE WORLD'S FASTEST SHOTGUN.

The Winchester[®] Super X3 is not only the world's fastest cycling shotgun (12 shots in 1.442 seconds), it's also the world's best fitting, sweetest handling and most advanced autoloader with the features you want in the field or marsh. Its performance cannot be equaled. It has set world records for speed in handling and cycling. The competition lags far behind the Super X3. Here's why the Winchester Super X3 should be in your gun rack.

CAST/DROP SHIMS

Every shooter is different, and no one stock will perfectly fit every person and their shooting style. Composite stock models of the Super X[®]3 allow you to easily adjust both cast on/cast off and drop at comb over a 1/4" range simply by inserting one of the six special shims between the receiver and the buttstock.

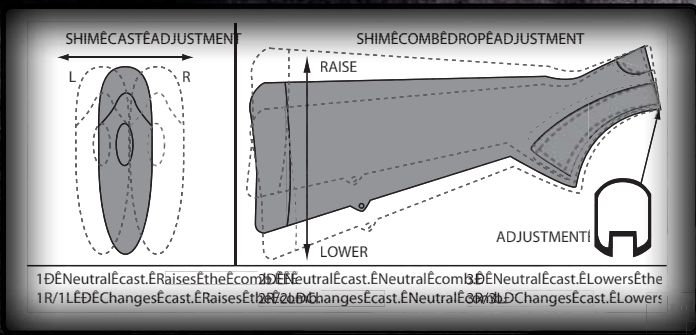

ELECTROLESS NICKEL-PLATED BOLT AND SHELL CARRIER

Breech bolts and shell carriers on all Super X[®]3 shotguns are plated with electroless nickel for longer life, reduced friction and greater corrosion resistance.



INFLEX RECOIL PAD

Getting pounded by your gun's recoil is a thing of the past with the new Inflex Technology Recoil Pad. Specially shaped rib structures located inside the pad help direct and channel the recoil impulse, moving the comb down and away from your cheek to reduce felt recoil to very manageable levels, even when shooting heavy magnum loads. A hard heel insert on the pad makes mounting the Super X[®]3 snag free.

DURA-TOUCH[®] Armor Coating

Composite models feature Dura-Touch Armor Coating for a sure, non-slip hold in cold, wet weather.

AMBIDEXTROUS SAFETY

The safety button on the Super X[®]3 is located at the rear of the trigger guard and is easily reversible for both right- or left-handed shooters.

LENGTH OF PULL SPACERS

There is no reason to put up with a shotgun that does not fit you, because proper stock fit is critical to comfortable and accurate shooting. Most Super X[®]3 shotguns come with two spacers that fit between the stock and the recoil pad, allowing easy adjustments to length of pull. When the length of pull is adjusted properly, you'll find you can shoulder the gun with ease and confidence, and the felt recoil you experience is greatly diminished. Adjustments range from 1 3/4" to 1 4/4" on wood stocks and from 1 1/4" to 1 3/4" on composite models.



DROP-OUT TRIGGER

The trigger group is easy to remove for cleaning.



PERMA-COTE™ UT FINISH
 UT stands for Ultra Tough. The unique gunmetal gray color of the Super X[®]3 is a heavy-duty finish that looks great and is extremely durable, scratch-resistant and corrosion-resistant to provide year after year of sharp looking performance.



LOAD DIVERSITY
 From light factory target shells to heavy waterfowl and turkey loads, the Super X[®]3 shoots them all reliably. 3" models fire everything from light, 1 1/8 oz., 2 3/4" target loads to 3" magnums, while 3 1/2" guns handle everything from 1 1/8 oz., 2 3/4" field loads up to heavy 3 1/2" magnums.

BACK-BORED TECHNOLOGY

.742" BACK-BORED TECHNOLOGY

Extensive research and testing has proven that when it comes to back-boring, .742" is the ideal interior barrel diameter for 12 gauge, ensuring tight, consistent patterns. Any larger and gases blow by the shot cup and reduce pellet velocity. Too small and the pellets are deformed as they pass through the forcing cone, causing poor ballistic performance.

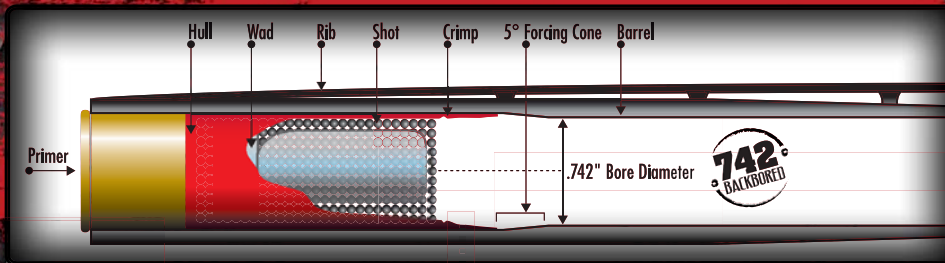

INVECTOR-PLUS™ CHOKE TUBES
 From the duck blind to the firing line, the Invector-Plus choke tube system is the world's favorite. The Super X[®]3 comes with either extended Signature or flush-mounted tubes, depending on the model. Additional tubes are available at your local Winchester Repeating Arms dealer.

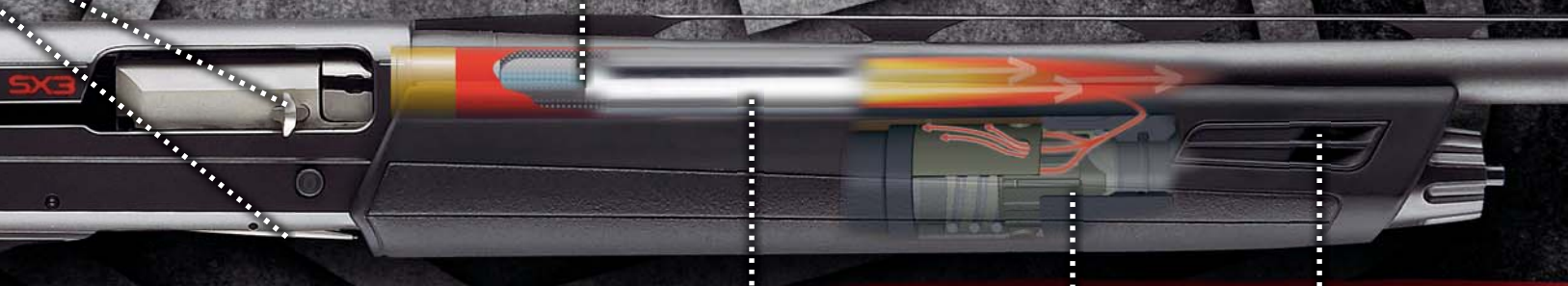

HARD CHROME CHAMBER AND BORE
 A chrome chamber and bore are optimum features when using steel or tungsten shot. This makes the surfaces impervious to wear and gives you superior protection from rust and corrosion. All Super X[®]3 shotguns except rifled barrels feature a hard-chromed bore and chamber.

QUADRA-VENT™
 Excess gases from heavy loads are channeled through the forward Quadra-Vent ports for greater efficiency to help tame punishing magnum load recoil.

ACTIVE VALVE system



THE ACTIVE VALVE SYSTEM

The Active Valve gas system automatically self-adjusts, allocating the exact gas pressure necessary to fire a wide range of loads — critical for any autoloader used in real life hunting or target shooting. When firing the heaviest magnum loads in 3 1/2" models, gases vent upward and a portion of the gases are vented forward out of the Quadra-Vent™ ports in the forearm, further regulating bolt speed. 3" models fire everything from light, 1 1/8 oz., 2 3/4" target loads to 3" magnums, while 3 1/2" guns handle everything from 1 1/8 oz., 2 3/4" field loads up to heavy 3 1/2" magnums.

12 SHOTS IN
1.442
 SECONDS

SX3®

SUPER X[®]3 FAST. FASTER. AND FASTEST.

The Winchester[®] Super X3 holds several world records for cycling speed, including being able to fire 12 shells in a mere 1.442 seconds. It's the kind of speed that translates into faster, more precise follow-up shots, and that means more targets broken at the end of your round, and more birds in your bag at the end of the day.



SX3[®]

	Item Number	Gauge	Barrel Length	Chamber	Magazine Capacity	Choke Tubes Included	Overall Length	Length of Pull	Drop at Comb	Drop at Heel	Nominal Wt. (lbs.)	Sugg. Retail
SX3 SPORTING (ADJUSTABLE COMB) (PRICES IN U.S. DOLLARS)												
NEW	511115392	12	28"	2¾"	4*	LF, IM, M, IC, SK	49¼"	14½"	1½"	1¼"	7%	\$1,629.99
NEW	511115393	12	30"	2¾"	4*	LF, IM, M, IC, SK	51¼"	14½"	1½"	1¼"	7½	1,629.99
NEW	511115394	12	32"	2¾"	4*	LF, IM, M, IC, SK	53¼"	14½"	1½"	1¼"	7%	1,629.99

*Total Capacity (Includes one shell in the chamber): 2¾" = 5, 3" = 4

- Five extended Signature choke tubes
- 12 shots in 1.442 seconds
- Tested in excess of 30,000 rounds without any critical parts failure



The Super X³ Sporting comes with a durable, fitted ABS hard case embossed with the Winchester[®] logo.

**12 SHOTS IN
1.442
SECONDS**

NEW



SUPER X³ SPORTING

Competitive shooting matches can heat up when the targets are tough, and you need all the gun you can get. The new Super X3 Sporting, with its lightweight, aluminum alloy receiver is as beautiful as it is strong. The barrel is configured in a lightweight profile with a ventilated rib and is ported to reduce muzzle jump. The proven Active Valve gas system with a new, unique sporting gas piston will reliably cycle all 2¾" loads from light to heavy. The Invector-Plus™

Choke System, partnered with precise .742" Back-Boring regulate the shot more efficiently than any other system. An adjustable comb stock and a Pachmayr[®] Decelerator[®] recoil pad help absorb felt recoil so you can shoot all day long. Its superb balance, quick shouldering, pointability and effortless swing become natural in your hands. No other sporting gun wraps such beauty and performance in one deluxe package.



T-Wrench, LF, IM, M, IC, SK



SUPER X[®]3 TOUGH GUNS FOR TOUGH CONDITIONS.

Autoloading Winchester[®] shotguns live on with this pair of reliable, great looking and top performing composite guns. These special Super X3 models offer enhanced ergonomics and the proven self-adjusting Active Valve system that provides speed, reduced felt recoil and reliability in rough weather.



12 SHOTS IN
1.442
SECONDS

- 50% less felt recoil than inertia-operated guns
- 5 shots in .49 seconds
- Tested in excess of 30,000 rounds without critical parts failure
- Removable trigger assembly

30

WINCHESTERGUNS.COM

SXB[®]

SUPER X[®]3 COMPOSITE

Available in both 12 and 20 gauge, the Winchester[®] Super X3 Composite shotgun is the model preferred by many hunters. Its tough composite stock, forearm and trim dimensions feel and balance perfectly in your hands. The Dura-Touch[®] Armor Coating provides a sure grip during wet weather conditions. The gunmetal gray Perma-Cote[™] UT (Ultra Tough) surface finish is applied to external metal surfaces for extreme corrosion protection. The bolt, slide and carrier are plated with electroless nickel for reduced friction and added corrosion resistance. A weight-saving alloy receiver and magazine tube, recoil spring system and

slim barrel with a machined rib contribute to the trim, 7 pound weight (12 gauge). The self-adjusting Active Valve gas system and proprietary next generation Inflex Technology recoil pad reduce felt recoil as much as 50% over that of inertia-operated autoloaders. Proven Back-Bored Technology, teamed with the Invector-Plus[™] choke tube system provide consistent, dense patterns. Three choke tubes (Full, Modified and Improved Cylinder), two length of pull stock spacers, drop and cast adjustment spacers and sling swivel studs are included on both 12 and 20 gauge models.



SUPER X[®]3 CANTILEVER DEER

Its rifled 22" barrel is optimized to provide unequalled accuracy with 2³/₄" and 3" sabot slugs. The proven Active Valve gas system on the Super X3 reduces recoil and cycles fast for incredible follow-up shot speed. The Weaver[™]-style cantilever rail design makes it easy to attach an electronic red dot or conventional scope, yet still allows you to use the adjustable rear sight and the TRUGLO[®] fiber-optic front sight. Available in both 12 and 20 gauge models, the

Cantilever Deer also features the durable gunmetal gray Perma-Cote[™] UT (Ultra Tough) surface finish on the barrel and receiver. The bolt, slide and carrier are plated with electroless nickel for reduced friction and extreme corrosion resistance. Dura-Touch[®] Armor Coating on the composite stock and forearm improves your grip in all conditions. Two length of pull stock spacers, drop and cast adjustment shims and sling swivel studs are included.

	Item Number	Gauge	Barrel Length	Chamber	Magazine Capacity	Choke Tubes Included	Overall Length	Length of Pull	Drop at Comb	Drop at Heel	Nominal Wt. (lbs.)	Sugg. Retail
SX3 COMPOSITE (PRICES IN U.S. DOLLARS)												
	511053371	12	26"	3"	4*	F, M, IC	47"	14 ¹ / ₄ "	1 ³ / ₄ "	2"	7	\$1,149.99
	511053361	12	28"	3"	4*	F, M, IC	49"	14 ¹ / ₄ "	1 ³ / ₄ "	2"	7 ¹ / ₂	1,149.99
	511053271	12	26"	3 ¹ / ₂ "	4*	F, M, IC	47"	14 ¹ / ₄ "	1 ³ / ₄ "	2"	7	1,279.99
	511053261	12	28"	3 ¹ / ₂ "	4*	F, M, IC	49"	14 ¹ / ₄ "	1 ³ / ₄ "	2"	7 ¹ / ₂	1,279.99
NEW	511053691	20	26"	3"	4*	F, M, IC	47"	14 ¹ / ₄ "	1 ³ / ₄ "	2"	6 ⁵ / ₈	1,139.99
NEW	511053692	20	28"	3"	4*	F, M, IC	49"	14 ¹ / ₄ "	1 ³ / ₄ "	2"	6 ³ / ₄	1,139.99
SX3 CANTILEVER DEER (PRICES IN U.S. DOLLARS)												
	511062340	12	22"	3"	4†	N/A	43"	14 ¹ / ₄ "	1 ³ / ₄ "	2"	7 ³ / ₄	\$1,219.99
NEW	511062640	20	22"	3"	4†	N/A	43"	14 ¹ / ₄ "	1 ³ / ₄ "	2"	7 ¹ / ₂	1,199.99

*Total Capacity (Includes one in the chamber): 2³/₄" = 5, 3" = 4, 3¹/₂" = 4 †Magazine capacity depends on shell length. Some slugs are longer than standard 2³/₄" shot shells.

SUPER X[®]3 RUGGED AND READY FOR ACTION.

The Super X3 shotgun blends the proven technology of the Active Valve gas system with the external enhancements you need to create an autoloader that's ready for any hunting challenge. The trim stock and forearm have special contours that enhance the effectiveness of the camouflage. Dura-Touch[®] Armor Coating provides a secure feel, even when wet or wearing heavy gloves. Whether laying in a wet blind, slogging through flooded timber or spending a day on the river jump shooting, you can count on the Super X3.



SX3[®]

12 SHOTS IN 1.442 SECONDS

- Self-adjusting Active Valve provides world-class performance capable of firing 12 shells in 1.442 seconds
- Patented next generation Inflex Technology pad absorbs recoil, and the slick heel insert won't grab clothing when shouldering
- Easily customized length of pull
- Lightweight magazine tube and recoil spring system trim weight by $\frac{3}{4}$ of a pound

	Item Number	Gauge	Barrel Length	Chamber	Magazine Capacity	Choke Tubes Included	Overall Length	Length of Pull	Drop at Comb	Drop at Heel	Nominal Wt. (lbs.)	Sugg. Retail
SX3 WATERFOWL (MOSSY OAK DUCK BLIND) (PRICES IN U.S. DOLLARS)												
	511074271	12	26"	3½"	4*	F, M, IC	47"	14¼"	1¾"	2"	7	\$1,479.99
	511074261	12	28"	3½"	4*	F, M, IC	49"	14¼"	1¾"	2"	7½	1,479.99
NEW	511074691	20	26"	3"	4*	F, M, IC	47"	14¼"	1¾"	2"	6½	1,339.99
NEW	511074692	20	28"	3"	4*	F, M, IC	49"	14¼"	1¾"	2"	6¾	1,339.99
SX3 ALL-PURPOSE FIELD (MOSSY OAK BREAK-UP INFINITY) (PRICES IN U.S. DOLLARS)												
	511117291	12	26"	3½"	4*	F, M, IC	47"	14¼"	1¾"	2"	7	\$1,479.99
	511117292	12	28"	3½"	4*	F, M, IC	49"	14¼"	1¾"	2"	7½	1,479.99
NEW	511117691	20	26"	3"	4*	F, M, IC	47"	14¼"	1¾"	2"	6½	1,339.99
NEW	511117692	20	28"	3"	4*	F, M, IC	49"	14¼"	1¾"	2"	6¾	1,339.99

*Total Capacity (Includes one in the chamber): 2¾" = 5, 3" = 4, 3½" = 4

SUPER X[®]3 WATERFOWL

Don't let a shiny shotgun flare wary geese. The Super X3 Waterfowl in high-definition Mossy Oak[®] Duck Blind[®] camo is the only choice for savvy waterfowlers, offering a weather-resistant composite stock and forearm with grip-enhancing Dura-Touch[®] Armor Coating finish. The bolt, slide and carrier are plated with electroless nickel for reduced friction and added corrosion resistance. Now available in 12 gauge 3½" and 20 gauge 3" models, it offers a barrel with a chrome chambered bore and improved ventilated rib design. It also features Back-Bored Technology with the Invector-Plus™ choke tube system for ideal shot patterns. The Active Valve gas system reliably cycles all factory ammunition from light field loads to heavy magnums. Three choke tubes (Full, Modified and Improved Cylinder), two length of pull stock spacers, drop and cast adjustment shims and sling swivel studs are included.



F, M, IC



DURA-TOUCH[®]
Armor Coating

ACTIVE VALVE
system

BACK-BORED
TECHNOLOGY

WATERFOWL



DURA-TOUCH[®]
Armor Coating

ACTIVE VALVE
system

BACK-BORED
TECHNOLOGY

ALL-PURPOSE FIELD



F, M, IC

SUPER X[®]3 ALL-PURPOSE FIELD

In the tight confines of flooded timber a balanced, fast swinging, reliable shotgun that can handle the most severe conditions is a must, and the Super X3 All-Purpose Field is your gun. Available in 12 gauge 3½" and 20 gauge 3" models, it uses the Active Valve gas system to cycle a wide variety of loads while reducing felt recoil vastly better than inertia-operated systems. It's fully concealed in new Mossy Oak[®] Break-Up[®] Infinity™ camo with Dura-Touch[®] Armor Coating for superb grip, feel and protection. The bolt, slide and carrier are plated with electroless nickel for reduced friction and added corrosion resistance. The barrel features the Invector-Plus™ choke tube system and Back-Bored Technology for optimal patterning. Three choke tubes (Full, Modified and Improved Cylinder), two length of pull stock spacers, drop and cast adjustment shims and sling swivel studs are included.



SUPER X[®]3 PRE-HEAT THE OVEN.

When you've tricked a noble tom into range, and your heart is beating through your chest, the next few seconds are crucial. You need a shotgun you can count on, like the exclusive Winchester[®] Super X3 NWTF[®] Extreme Turkey. It's made for taking big toms with Mossy Oak[®] Break-Up[®] Infinity[™] camo for ultimate concealment, along with dense patterning extended extra-full choke tubes. Take the Winchester Super X3 NWTF Cantilever Extreme Turkey on your upcoming hunt. It's the perfect tool for trophy turkey hunting.



	Item Number	Gauge	Barrel Length	Chamber	Magazine Capacity	Choke Tubes Included	Overall Length	Length of Pull	Drop at Comb	Drop at Heel	Nominal Wt. (lbs.)	Sugg. Retail
SX3 NWTF EXTREME TURKEY (MOSSY OAK BREAK-UP INFINITY) (PRICES IN U.S. DOLLARS)												
NEW	511119290	12	24"	3½"	4*	T	45	14¼	1¾"	2"	7½	\$1,559.99
NEW	511119690	20	24"	3"	4*	T	45	14¼	1¾"	2"	7½	1,399.99

*Total Capacity (Includes one in the chamber): 2¾" = 5, 3" = 4, 3½" = 4



QUADRA-VENT™ FORWARD DUCTING SYSTEM. This improved design facilitates more efficient venting of excess gases forward and away from the shooter. This is a special advantage when shooting heavy 12 gauge 3½" magnum loads where the Active Valve gas system regulates bolt speed by venting off additional gases through the piston.



INFLEX TECHNOLOGY RECOIL PAD. This ultra soft pad offers the best recoil absorption available, especially when shooting heavy turkey loads. The proprietary construction and material promote a directional deflection of recoil forces, pulling the stock comb away from your face, reducing felt recoil and muzzle climb. The hard heel insert allows no-sag shouldering.



FINE TUNE CAST AND DROP. All Super X[®]3 Composite shotguns include shims to adjust stock drop and cast over a ¼" range. The shims fit between the stock and receiver to lock in your personalized dimensions.



NEW

EXTREME TURKEY

DURA-TOUCH[®]
Armor Coating

ACTIVE VALVE
system

BACK-BORED
TECHNOLOGY

TRUGLO



SUPER X[®]3 NWTF[®] EXTREME TURKEY

For tough turkey hunts, the Super X3 NWTF Extreme Turkey is the ideal choice. The Active Valve system expels excess gases to reduce recoil before it reaches your shoulder. The 24" barrel offers Back-Bored Technology, with a 3½" chamber in 12 gauge and a 3" chamber in 20 gauge. An Invector-Plus™ Extra-Full Extended Turkey choke tube helps make this one incredible turkey gun. Extra features include protective Dura-Touch[®] Armor Coating on the weather-resistant Mossy Oak[®] Break-Up[®] Infinity™ camo composite stock, an adjustable rear sight and a TRUGLO[®] fiber-optic front sight. Steel sling swivel studs are included.

EXTRA-FULL TURKEY CHOKE TUBE

A tight, dense pattern of heavy shot is critical for taking turkeys. You get an Invector-Plus™ Extra-Full Turkey choke tube standard with the Super X[®]3 NWTF[®] Extreme Turkey. The black knurled band makes it easy to install or remove and the camo band won't give you away to a sharp-eyed tom.



**12 SHOTS IN
1.442
SECONDS**

SX3[®]

SUPER X[®]3 FEEL THE DIFFERENCE WITH THE NEW COMPACT.

What could be better than owning a versatile shotgun you could take to the field, marsh or use for shooting clays at the range? The Super X3 Walnut autoloading shotgun is right at home for any shooting situation, in any weather, with any 2¾" or 3" load, all day. Both the 12 and 20 gauge models feature Back-Bored Technology for the ideal combination of shot uniformity and velocity. The gunmetal gray Perma-Cote™ UT (Ultra Tough) finish is more durable and corrosion resistant than traditional blued finishes. For balance, superior fit, smooth follow-through and just plain fun shooting, you can't beat a new Winchester® Super X3.



12 SHOTS IN
1.442
SECONDS

SX3[®]



	Item Number	Gauge	Barrel Length	Chamber	Magazine Capacity	Choke Tubes Included	Overall Length	Length of Pull	Drop at Comb	Drop at Heel	Nominal Wt. (lbs.)	Sugg. Retail
SX3 WALNUT FIELD (PRICES IN U.S. DOLLARS)												
	511054371	12	26"	3"	4*	F, M, IC	46¾"†	14"†	1½"	1¾"	6¾	\$1,219.99
	511054361	12	28"	3"	4*	F, M, IC	48¾"†	14"†	1½"	1¾"	6⅞	1,219.99
	511054691	20	26"	3"	4*	F, M, IC	46¾"†	14"†	1¾"	1⅞"	6⅞	1,219.99
	511054692	20	28"	3"	4*	F, M, IC	48¾"†	14"†	1¾"	1⅞"	6½	1,219.99
SX3 COMPACT FIELD (PRICES IN U.S. DOLLARS)												
NEW	511118391	12	26"	3"	4*	F, M, IC	45¾"†	13"†	1½"	1¾"	6¾	\$1,219.99
NEW	511118392	12	28"	3"	4*	F, M, IC	47¾"†	13"†	1½"	1¾"	6⅞	1,219.99
NEW	511118691	20	26"	3"	4*	F, M, IC	45¾"†	13"†	1¾"	1⅞"	6⅞	1,219.99
NEW	511118692	20	28"	3"	4*	F, M, IC	47¾"†	13"†	1¾"	1⅞"	6½	1,219.99

*Total Capacity (Includes one in the chamber) 12 Gauge: 2¾" = 5, 3" = 5; 20 Gauge: 2¾" = 5 † Super X3 Field shotguns come with ¼" spacer installed. Measured without spacer.



UNIQUE CHECKERING. Stylish linear checkering graces the Super X[®]3 Walnut Field stock, offering bold looks and an enhanced grip.



ADJUSTABLE LENGTH OF PULL. Spacers fit between the stock and recoil pad to customize the fit of your Super X[®]3 Walnut Field to your exact measurements. Two spacers are included with every Super X3 Walnut Field to adjust stock length between 13³/₄" and 14¹/₄" on wood stocks and 14¹/₄" and 14³/₄" on composite stocks.



PERMA-COTE™ UT FINISH. UT stands for Ultra Tough. The unique gunmetal gray color of the Super X[®]3 is a heavy-duty finish that looks incredible and is extremely durable, scratch-resistant and corrosion-resistant for years of sharp looking performance.



SUPER X[®]3 WALNUT FIELD

Bold looks and innovative features make the Winchester[®] Super X3 Field shotgun a shotgun to be reckoned with. The 26" barrel 12 gauge model weighs in at a scant 6³/₄ pounds, thanks to a weight-saving magazine tube and recoil spring system, slim barrel with a machined rib and an alloy receiver. The 3" chambered Super X3 Walnut Field has all the features you want in a field or sporting gun. The self-adjusting Active Valve gas system reduces recoil significantly more than inertia-operated systems and a soft Inflex Technology recoil pad offers the best recoil absorption available. Trim grip and forearm dimensions add to the lightweight,



F, M, IC



fast-handling feel. Back-Bored Technology and the Invector-Plus™ choke tube system work together to provide perfect patterns. A unique gunmetal gray Perma-Cote™ UT (Ultra Tough) surface finish is applied to external surfaces for extreme corrosion protection. The bolt, slide and carrier are plated with electroless nickel for reduced friction and added corrosion resistance. This is one shotgun you must experience to believe. Three choke tubes (Full, Modified, Improved Cylinder) and two stock spacers for length of pull adjustments are included.



F, M, IC



SUPER X[®]3 COMPACT FIELD

Not all shooters and hunters are built the same, and often it takes some fitting to get a shotgun to shoulder quickly, point well and swing on target. For smaller-framed shooters, women and youth, the new Super X3 Compact in 12 or 20 gauge could change their entire outlook on hunting and sport shooting. You feel the difference as soon as you pick one up. The lightweight aluminum alloy receiver, ultra light magazine tube and spring, satin walnut stock with a shortened length of pull trim nearly ³/₄ of a pound of weight compared to the Super X[®]2. A premium Pachmayr[®]

Decelerator[®] recoil pad helps manage felt recoil. The lighter weight barrel further reduces weight with a narrow profile and a machined rib. Both 12 and 20 gauge models feature Back-Bored Technology for the ideal combination of shot uniformity and velocity. The gunmetal gray Perma-Cote™ UT (Ultra Tough) finish is more durable and corrosion resistant than traditional blued finishes. For balance, superior fit and smooth follow-through there is nothing more suited for younger, lighter-framed shooters than the new Winchester[®] Super X3 Compact.

SUPER X[®] PUMP

THE WORLD'S FASTEST PUMP ACTION.

Whether its super-speed clays or fast-flushing upland game, keep up with shooting's fastest action with the Super X Pump, the perfect choice for pump shotgun lovers. Because of its inertia-assisted slide-action, it's the fastest in the world for follow-up shots. Three shots can be delivered in just a half second. Cycle one through and see if it's not the finest fitting, sweetest handling and fastest pump out there.

BLACK CHROME PROTECTION

Better than conventional bluing, black chrome finishes stand up to years of wear and last longer. Parts and surfaces are easier to clean and stay cleaner.



ROTARY BOLT

Four massive lugs provide support, strength and solid lockup in the receiver of the lightning-fast Super X[®] Pump. Under recoil the mass of your body begins to slow the rearward travel of the shotgun, while the inertia of the bolt, slide and forearm continue cycling the action to help you get a head start on your next shot. Dual steel action guide bars channel and eliminate twisting, binding, wasted time and energy when cycling the action.



INFLEX RECOIL PAD

Recoil absorption is critical on any shotgun, and the new Super X[®] Pump has the best pad made. Rib structures inside the pad help direct and channel the recoil impulse, moving the comb down and away from your cheek. A hard heel insert on the pad makes mounting the Super X Pump snag free.

FAMILIAR DIMENSIONS

The Super X[®] Pump composite stock provides you with the same familiar feel of the Super X3. Pistol grip radius, trigger reach, comb height and length of pull are all patterned after the fastest autoloader in the world. The stock bolt passes through the wrist of the stock and attaches solidly into the back of the alloy receiver.



DROP-OUT TRIGGER GROUP

Removing one pin allows you to drop out the complete trigger system for cleaning and inspection. Nothing could be simpler in keeping your Super X[®] Pump in excellent working condition.



.742" BACK-BORED TECHNOLOGY

Extensive research and testing has proven that when it comes to back-boring, .742" is the ideal 12 gauge interior barrel diameter, ensuring tight, consistent patterns. Any larger and gases blow by the shot cup and reduce pellet velocity. Too small and the pellets are deformed as they pass through the forcing cone, causing poor ballistic performance.

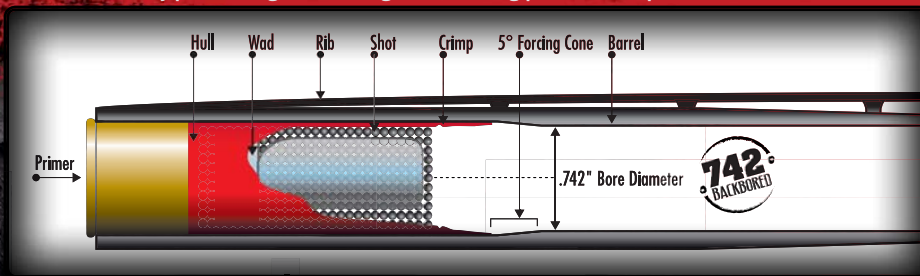

INVECTOR-PLUS™ CHOKE TUBES

From the duck blind to the firing line, the Invector-Plus choke tube system is the world's favorite. The Super X® Pump comes with full, modified and improved cylinder flush-mounted tubes so your gun is ready to shoot right out of the box. Additional tubes are available at your local Winchester Repeating Arms dealer.

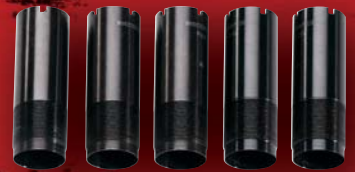

HARD CHROME CHAMBER AND BORE

A chrome chamber and bore are optimum features when using steel or tungsten shot. This makes the surfaces impervious to wear and gives you superior protection from rust and corrosion. All Super X® Pump shotguns feature a hard-chromed bore and chamber.

CROSSBOLT SAFETY

The crossbolt safety button on the Super X® Pump is located on the front of the trigger guard for easy access, even when wearing gloves.

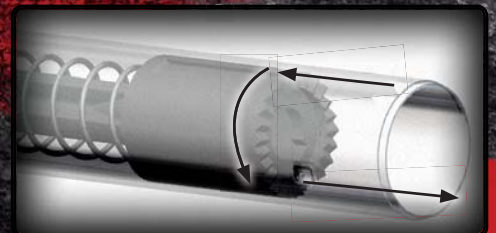

SPEED-PLUG SYSTEM

When removing the three-shot adapter, simply remove the magazine cap, push on the spring retainer holding the spring in place and remove the adapter. It's trouble-free and in seconds you can remove or install the adapter.

SXP™

SUPER X[®] PUMP SPEED CYCLER.

The Winchester[®] Super X Pump is slide action fun. The inertia-assisted rotary bolt sets the record with three shots delivered in just a half second. Pick one up, shoulder it, shoot it and see if it's not the best camouflaged, sweetest handling, fastest pump shotgun in the marsh.



SXP[™]

40

WINCHESTERGUNS.COM



HARD CHROME CHAMBER AND BORE
 A chrome chamber and bore are optimum features when using steel or tungsten shot. This makes the surfaces impervious to wear and gives you superior protection from rust and corrosion. All Super X® Pump shotguns feature a hard-chromed bore and chamber.



SPEED-PLUG SYSTEM
 When removing the three-shot adapter, simply remove the magazine cap, push on the spring retainer holding the spring in place and remove the adapter. It's trouble-free and in seconds you can remove or install the adapter.



NEW **BACK-BORED TECHNOLOGY** **WATERFOWL**



SUPER X® PUMP WATERFOWL

There are plenty of waterfowl shotguns in every sporting goods store across America, but there is only one genuine Winchester®. The newest Super X Pump is dressed in Mossy Oak® Duck Blind® camo, rugged and ready for a dawn with the ducks. It will digest 2¾" and 3" steel, tungsten, bismuth and lead loads through a new, chrome-plated .742" back-bored barrel with Invector-Plus™ chokes, ensuring optimum patterns. Available with either a 26" or 28" barrel, you won't have to worry about this pump shotgun keeping up with fast-flying waterfowl.



	Item Number	Gauge	Barrel Length	Chamber	Magazine Capacity	Choke Tubes Included	Overall Length	Length of Pull	Drop at Comb	Drop at Heel	Nominal Wt. (lbs.)	Sugg. Retail
NEW	512254391	12	26"	3"	4*	F, M, IC	46½"	13¾"	1½"	2"	6¾	\$529.99
NEW	512254392	12	28"	3"	4*	F, M, IC	48½"	13¾"	1½"	2"	6¾	529.99

*Total Capacity (Includes one shell in the chamber): 2¾" = 5, 3" = 4

SUPER X[®] PUMP LOADED WITH SPEED.

Light weight, centered balance and instant pointability are trademarks of the fastest pump shotgun ever. Making follow-up shots like an autoloader comes from the inertia-assisted slide-action that can deliver three shots in a mere half-second. Super speed comes standard with the Super X Pump.



SXP

Stay safe and confident with the do-it-all Defender. Use it for home security, competition or hunting. It also packs easily for camping. The six-shell total capacity, composite stock and forearm impart total capability. It's all the gun you need for security and peace of mind.



DEFENDER[™]

The Defender is easy to pack and carry and handles buckshot or rifled slugs efficiently through the fully chrome-plated, 18" fixed cylinder choked barrel for wide patterning. This open choke is also very accurate when using Foster-type slugs. It has non-glare metal surfaces with a tough composite stock and forearm. A positive, deeply grooved forearm assists with control and stability.

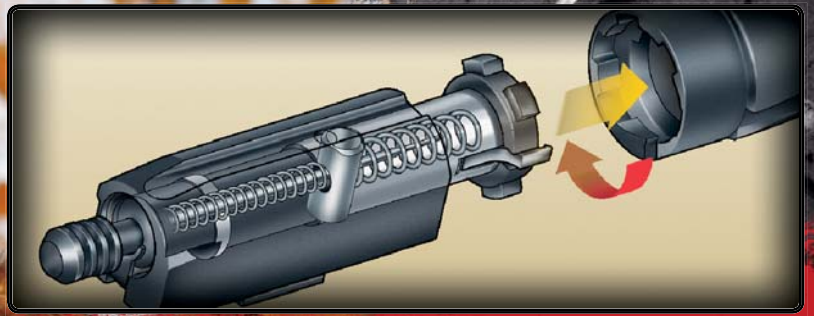

THE ROTARY BOLT. Four massive lugs provide support, strength and solid lockup in the receiver of the lightning-fast Super X® Pump. Under recoil the mass of your body begins to slow the rearward travel of the shotgun, while the inertia of the bolt, slide and forearm continue cycling the action to help you get a head start on your next shot. Dual steel action guide bars channel and eliminate twisting, binding, wasted time and energy when cycling the action.



BACK-BORED TECHNOLOGY

BLACK SHADOW FIELD



F, M, IC

BLACK SHADOW® FIELD

The Black Shadow Field gives you rugged reliability with a non-glare matte finish on the barrel and receiver that won't cause birds to flare. The durable composite stock and forearm are up to the toughest conditions. The hard working Super X® Pump action fires all factory 2¾" and 3" steel, tungsten, bismuth and lead loads through a new, chrome plated .742" back-bored barrel with Invector-Plus™ choke tubes to ensure optimum patterns. It's available with either a 26" or 28" barrel.

- All barrels are fully chrome plated for added durability and are easy to clean, giving you that extra margin of protection when hunting in wet conditions
- Inflex Technology Recoil Pad



DEFENDER

Item Number	Gauge	Barrel Length	Chamber	Magazine Capacity	Choke Tubes Included	Overall Length	Length of Pull	Drop at Comb	Drop at Heel	Nominal Wt. (lbs.)	Sugg. Retail
SXP BLACK SHADOW FIELD (PRICES IN U.S. DOLLARS)											
512251391	12	26"	3"	4*	F, M, IC	46½"	13¾"	1½"	2"	6¾	\$429.99
512251392	12	28"	3"	4*	F, M, IC	48½"	13¾"	1½"	2"	6¾	429.99
SXP DEFENDER (PRICES IN U.S. DOLLARS)											
512252395	12	18"	3"	5*	N/A	38½"	13¾"	1½"	1½"	6¼	\$379.99

*Total Capacity (Includes one shell in the chamber): Field: 2¾" = 5, 3" = 4, Defender: 2¾" = 6, 3" = 5



Item Number	Gauge	Description	Diameter	Constriction	Sugg. Retail
-------------	-------	-------------	----------	--------------	--------------

SIGNATURE INvEcToR-PLUS choKE TUBES

12 Gauge for Winchester Supreme, Select, Super X2, Super X3 and Super X Pump Shotguns

61307103	12	Turkey	.660	.082	\$44.99
6130703	12	Extra-Full Trap	.700	.040	44.99
6130713	12	Full	.705	.035	44.99
6130723	12	Light Full	.710	.030	44.99
6130733	12	Improved Modified	.715	.025	44.99
6130743	12	Modified	.720	.020	44.99
6130753	12	Light Modified	.725	.015	44.99
6130763	12	Improved Cylinder	.730	.010	44.99
6130773	12	Skeet	.735	.005	44.99
6130783	12	Cylinder	.740	.000	44.99
6130793	12	Spreader	Rifled	—	64.99

INvEcToR-PLUS cho KES

12 Gauge & 20 Gauge for Winchester Supreme, Select, Super X2, Super X3 and Super X Pump Shotguns

613061	20	Full	.606	.024	\$29.99
613062	20	Improved Modified	.612	.018	29.99
613063	20	Modified	.615	.015	29.99
613064	20	Improved Cylinder	.621	.009	29.99
613065	20	Skeet	.624	.006	29.99
613066	20	Cylinder	.630	.000	29.99
613050	12	Extra-Full	.700	.040	29.99
613051	12	Full	.705	.035	29.99
613052	12	Improved Modified	.715	.025	29.99
613053	12	Modified	.720	.020	29.99
613054	12	Improved Cylinder	.730	.010	29.99
613055	12	Skeet	.735	.005	29.99
613056	12	Cylinder	.740	.000	29.99
6130043	12	T-Wrench	—	—	19.99

STANDARD INvEcToR cho KES

12 Gauge for Winchester Super X2 Practical Models

6130303	12	Full	.690	.035	\$19.99
6130313	12	Improved Modified	.700	.025	19.99
6130323	12	Modified	.705	.020	19.99
6130333	12	Improved Cylinder	.715	.010	19.99
6130343	12	Skeet	.720	.005	19.99
6130353	12	Cylinder	.725	.000	19.99
6130033	12	T-Wrench	—	—	19.99

WINch ESTER® cho KE TUBES

Winchester Signature choke tubes are unsurpassed in the shotgun industry. In collaboration with Briley® one of the most renowned makers of choke tubes in the world, the Invector-Plus™ and Standard Invector™ tubes are carefully machined from the best materials and calibrated to the strictest tolerances to deliver shot patterns exceeding your highest expectations. Installing these tubes in your barrel insures that you are getting optimum patterning for the most challenging of wild game and the most difficult presentations in clay target shooting.

Item Number	Gauge	Chamber	Barrel Length	Description	Sugg. Retail
-------------	-------	---------	---------------	-------------	--------------

SUPER X3 FIELD AND TURKEY BARRELS • 12 GAUGE

611053271	12	3½"	26"	Perma-Cote UT, Vent Rib, with 1 Modified Invector-Plus Choke Tube	\$519.99
611053261	12	3½"	28"	Perma-Cote UT, Vent Rib, with 1 Modified Invector-Plus Choke Tube	519.99
611054371	12	3"	26"	Perma-Cote UT, Vent Rib, with 1 Modified Invector-Plus Choke Tube	419.99
611054361	12	3"	28"	Perma-Cote UT, Vent Rib, with 1 Modified Invector-Plus Choke Tube	419.99
611053253	12	3½"	24"	Perma-Cote UT, Vent Rib, TRUGLO Sights, w/1 X-Full Extended Invector-Plus Choke Tube	519.99

SUPER X3 DEER BARRELS • 12 GAUGE

611108340	12	3"	22"	Black, Rifled, Cantilever Scope Mount and Synthetic Forearm*	\$579.99
611107340	12	3"	22"	MOBU, Rifled, Cantilever Scope Mount and Synthetic Forearm*	659.99
611121340	12	3"	22"	MOBU Infinity, Rifled, Cantilever Scope Mount and Synthetic Forearm*	659.99
611108240	12	3½"	22"	Black, Rifled, Cantilever Scope Mount and Synthetic Forearm*	629.99
611107240	12	3½"	22"	MOBU, Rifled, Cantilever Scope Mount and Synthetic Forearm*	699.99
611121240	12	3½"	22"	MOBU Infinity, Rifled, Cantilever Scope Mount and Synthetic Forearm*	699.99

SUPER X2 FIELD AND TURKEY BARRELS • 12 GAUGE

611063253	12	3½"	24"	Matte Blue, Vent Rib, TRUGLO Sights, w/1 X-Full Extended Invector-Plus Choke Tube	\$499.99
611064350	12	3"	26"	Gloss Blue, Vent Rib, with 1 Modified Invector-Plus Choke Tube	379.99
611063346	12	3"	28"	Matte Blue, Vent Rib, with 1 Modified Invector-Plus Choke Tube	379.99

SUPER X2 DEER BARREL • 12 GAUGE

611101240	12	3½"	22"	Matte Blue, Rifled, Cantilever Scope Mount	\$549.99
-----------	----	-----	-----	--	----------

Do not attempt the use of 3½" chambered barrels with 3" receivers nor 3" chambers with 3½" receivers.

*To prevent damage to forearms, all Super X3 rifled cantilever barrels are delivered with a new forearm specifically designed to fit over the thicker, rifled barrel wall.



HINGED FLoO RPLATE mAGAz INE



DETACHABLE FLoO RPLATE mAGAz INE

Item Number	Description	Sugg. Retail
-------------	-------------	--------------

SUPER X RIFLE HINGED FLoO RPLATE mAGAz INE

112029907	30-06 Sprg	\$69.99
112029906	300 Win Mag	69.99
112029904	270 WSM	69.99
112029905	300 WSM	69.99

SUPER X RIFLE DETACHABLE FLoO RPLATE mAGAz INE

112029903	30-06 Sprg	\$69.99
112029902	300 Win Mag	69.99
112029900	270 WSM	69.99
112029901	300 WSM	69.99

CUSTOMER SERVICE FOR WINCHESTER® FIREARMS

You can expect the same great Customer Service you've become accustomed to over the years. Expert gunsmiths can help you with the most technical problems and repairs to your firearms. There are many Authorized Repair Centers (ARC) throughout the country with gun repair professionals who know your firearm inside and out. If you need service on current models, as well as older Model 70, Model 94, Model 9422 or Model 1300 firearms, please contact one of the Authorized Repair Centers or our main Service Center in Arnold, Missouri. Please call (800) 333-3288 for more information.

WINCHESTER® REPEATING ARMS

Customer Service Department
275 Winchester Avenue
Morgan, UT 84050
(800) 945-5237
(801) 876-3440

Parts and Service
3005 Arnold Tenbrook Road
Arnold, MO 63010
(800) 322-4626



All Winchester firearms are shipped with a free locking device to assist in the safe storage of firearms. (Not shown actual size.)



FOR FIREARMS: WINCHESTERGUNS.COM

FOR AMMUNITION: WINCHESTER.COM

Owner's manuals for all Winchester® firearms in this or previous catalogs are available upon request at no charge. Owners of Winchester firearms without owner's manuals are encouraged to view one online or request one at the address below. Some models and calibers are only made periodically. Winchester Repeating Arms (WRA) reserves the right to delay, postpone or discontinue production of any Winchester firearm for any reason without notice. All specifications in this catalog are subject to change without notice. Weights, stock dimensions, wood appearance, etc., may vary slightly between individual firearms. Wood is a natural product. No two pieces are alike and variation between stocks is to be expected. WRA reserves the right to modify or change specifications without notice. WRA will make every effort to make sure this catalog is accurate at the time of printing and apologizes for any errors in photographs, descriptions and specifications.

Please note that the following models are or were manufactured in Japan: Models 1885, 1886, 1892, 1894, 1895, 63 and 52B. Super X2, Super X3, and 101 shotguns are manufactured in Belgium and assembled in Portugal. Model 70 rifles are manufactured in the USA. The following trademarks are used with permission from the Olin Corporation: Winchester, the Horse and Rider design, Super X, SX2 design, Super X2, SX3 design, Super X3, SXR design, Model 1892, Select, Model 101, Model 1300, Model 94, Model 70, Model Super X Pump and the red W design. Other trademarks used in this catalog: Mossy Oak Duck Blind and Mossy Oak Break-Up Infinity are registered trademarks of Haas Outdoors. Pachmayr and Decelerator are registered trademarks of Lyman. Invector-Plus, Dura-Touch and Perma-Cote are trademarks of Browning. TRUGLO is a trademark of Truglo, Inc. Marble's is a trademark of Marble's Arms.

© Copyright, WRA, September 2010. No part of this catalog may be reproduced without the written permission of Winchester Repeating Arms. Suggested retail pricing is in U.S. dollars and approximate and subject to change without notice. If you have any questions concerning Winchester brand firearms, visit your Winchester firearms dealer or write to: Winchester Repeating Arms, 275 Winchester Ave., Morgan, UT 84050-9333. Printed in USA. GAC1009200/10063 Winchester firearms are imported by BACO, Inc. Winchester is a registered trademark of Olin Corporation.



A portion of the sale of every Winchester firearm is proudly donated to the Heritage Fund, which helps to expand the legal defense against politically motivated lawsuits against the hunting and shooting industry. Working together, the rightful tradition of firearms in America will continue.

CYCLE THROUGH THESE NEW MODELS.

The Model 94[®], America's favorite lever-action gun, has returned and so have many of its famous siblings. The Winchester[®] Model 94 Short Rifle and Sporter demand your attention. There's the new Model 1886 Short Rifle, plus a sweet-handling Model 1892 Carbine in four popular calibers. In the Winchester Model 70[®] line you'll find a new Featherweight Compact, made with pride in the USA. With a 1 MOA accuracy standard and the innovative M.O.A.[™] Trigger System, it's still the most-loved bolt-action on the market. Upland fans will love the Model 101[®], the only Belgian-made production over and under on the market. The Super X[®]3, the fastest cycling autoloader ever, has four new models and the Super X[®] Pump has a new Waterfowl model. The most exciting Winchester firearms lineup ever is inside!

PRSR STD
U.S. POSTAGE PAID
PERMIT 315
OGDEN, UT

Winchester Repeating Arms
275 Winchester Ave., Morgan, UT
84050-9333

We proudly support these organizations.



WINCHESTER

REPEATING ARMS